

**EX-TEC® SR5, SR4, SR2  
VARIOTEC® 8**

# Operating- Instructions

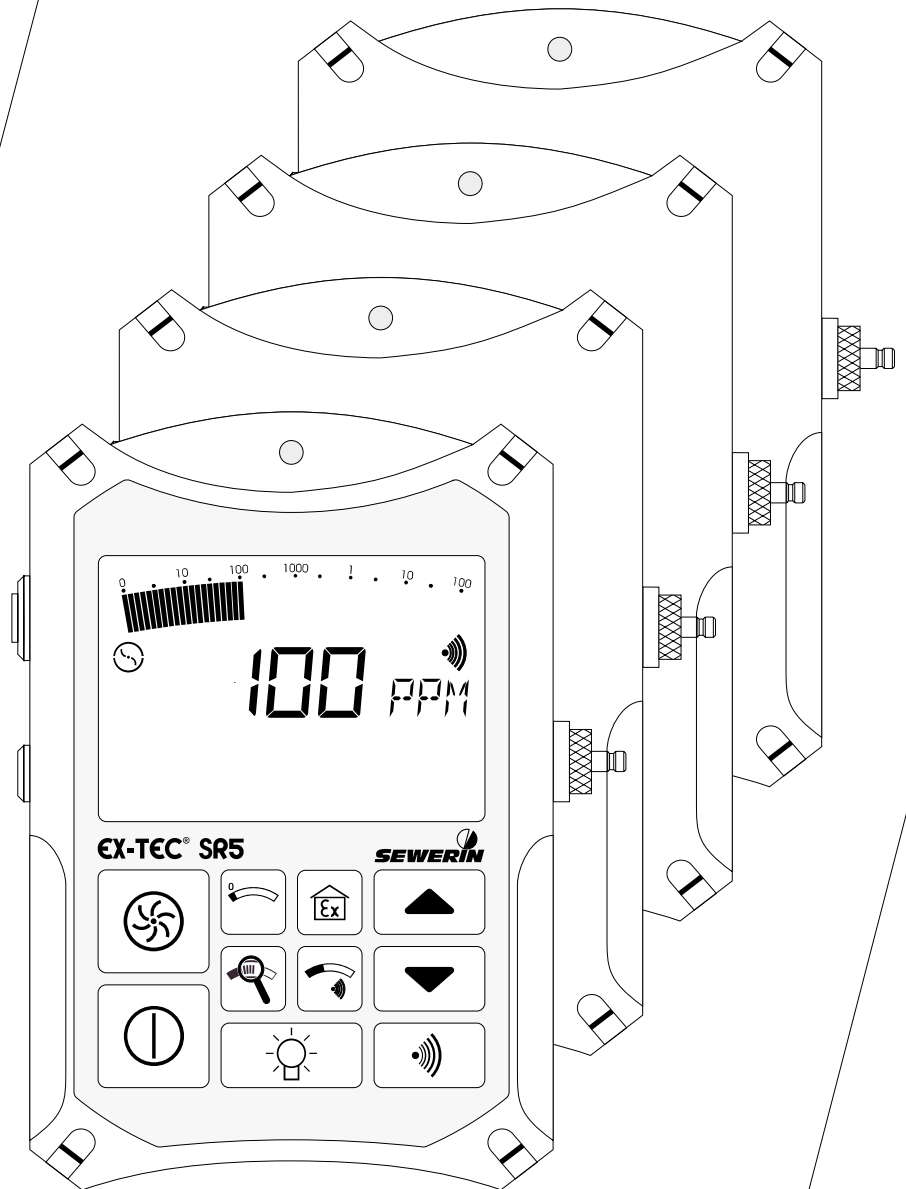

New declaration of conformity. Download:  
[www.sewerin.com](http://www.sewerin.com) ▶ Certificates & Approvals

**SEWERIN**

GB  
102424

## Measurable success by Sewerin equipment

---

You settled on a precision instrument.

A good choice!

Our equipment stands out for guaranteed safety, optimal output and efficiency.

They correspond with the national and international guide-lines.

These operating instructions will help you to handle the instrument quickly and competently.

Please pay close attention to our operating instructions before usage.

In case of further queries our staff is at your disposal at any time.

Yours

Hermann Sewerin GmbH

Robert-Bosch-Straße 3

D-33334 Gütersloh

 : +49 - (0) - 52 41/9 34-0

**FAX** : +49 - (0) - 9 34-4 44

[http:// www.sewerin.com](http://www.sewerin.com)

---

Design of the: **EX-TEC® SR5**

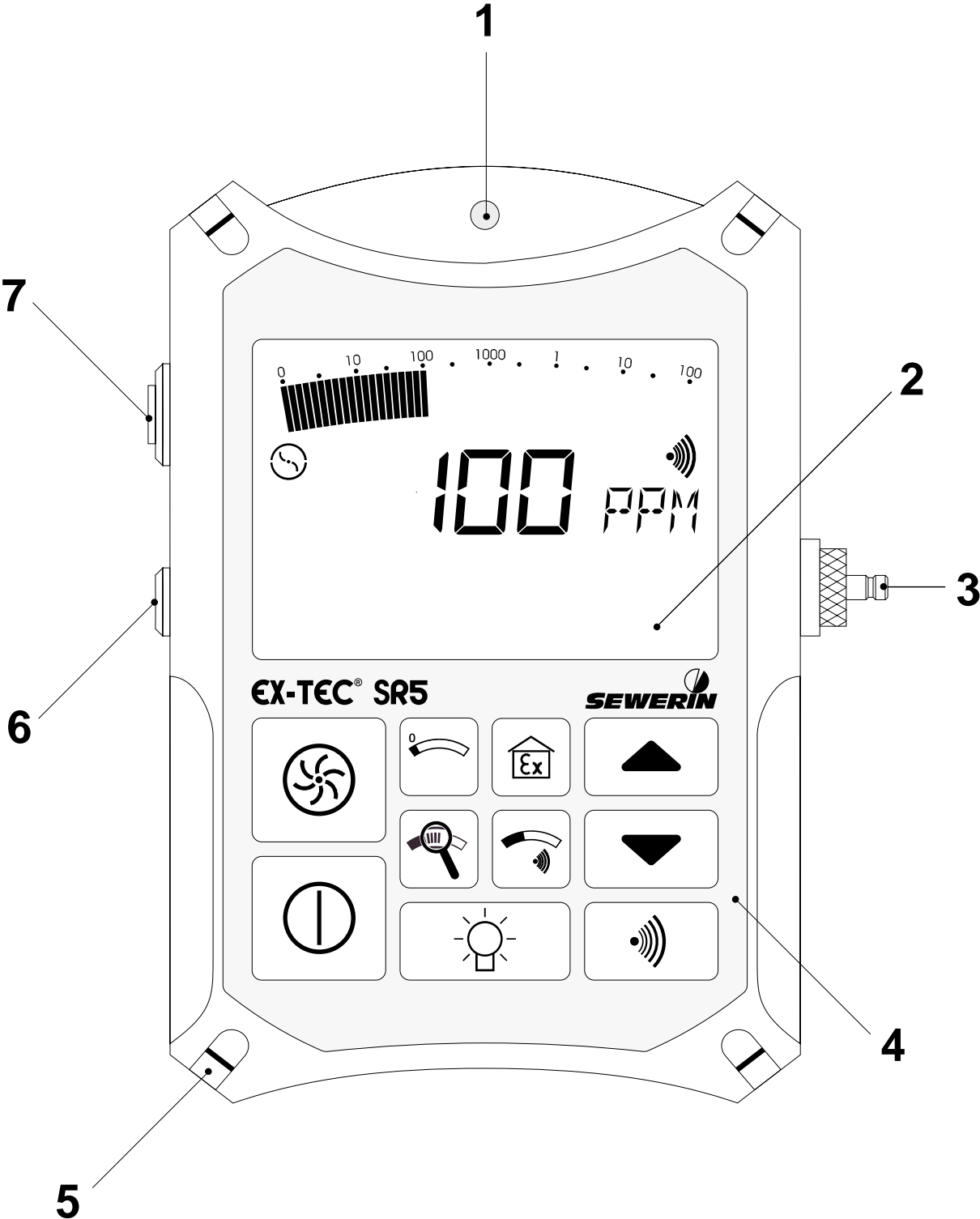

## **Notes**

# **EX-TEC<sup>®</sup> SR 5, SR4, SR2 VARIOTEC<sup>®</sup> 8**

**Operating Instructions ..... pages 3 - 52**



102424 - 04/20.08.1999

## **For your safety \***

The law governing technical equipment (the Law on the Safety of Appliances) of 24.06.1968 (BGBl.I, page 717) as amended by the Amendment Law of 13.08.1979 (BGBl.I, page 1432) requires the following matters to be drawn to your attention:

### **Comply with the Operating Instructions.**

Before operating or adjusting the appliance you must be thoroughly familiar with this operating manual. You must comply with it in every respect.

The appliance is designed only for the application described and for industrial (commercial) use.

### **Liability for Function and/or Damage**

Liability for the functioning of the appliance passes to the owner or operator in all cases in which the appliance has been improperly maintained or repaired by persons not associated with SEWERIN Service or if it has been used for a purpose not in accordance with its designated application.

You should therefore always use original SEWERIN accessories with the **EX-TEC® SR 5, SR4, SR2** and **VARIOTEC® 8**.

Hermann Sewerin GmbH accepts no responsibility for damage due to a failure to comply with the foregoing instructions. The guarantee and liability terms of the Hermann Sewerin GmbH terms of sale and supply are not extended by the foregoing.

We reserve the right to make technical changes in the course of continued development.

HERMANN SEWERIN GMBH

---

\* All references to laws, statutes and norms relate to the legislation of the Federal Republic of Germany.

---

<b>For your safety .....</b>	<b>4</b>
<b>1.0 The EX-TEC® SR5, SR4, SR2 and VARIOTEC® 8 models .....</b>	<b>6</b>
1.1 Tests .....	8
1.2 Probe systems .....	9
<b>2.0 Measuring operation.....</b>	<b>11</b>
2.1 Switching on .....	11
2.2 Illumination and contrast .....	12
2.3 Pump operation .....	13
2.4 Alarm signal and volume .....	14
2.5 Alarm threshold value .....	14
2.6 Switching measuring ranges .....	15
2.7 Zero-point adjustment .....	16
2.8 Workplace monitoring .....	16
2.9 Battery alarm.....	18
2.10 Switching off .....	18
<b>3.0 Charging technique.....</b>	<b>19</b>
<b>4.0 Inspection, testing and maintenance.....</b>	<b>21</b>
4.1 Test sets .....	22
4.2 Test gases .....	24
4.3 Function testing .....	25
<b>5.0 Adjustment.....</b>	<b>26</b>
<b>6.0 Technical specifications.....</b>	<b>34</b>
<b>7.0 Technical data.....</b>	<b>37</b>
<b>8.0 Accessories.....</b>	<b>39</b>
<b>9.0 Error messages .....</b>	<b>40</b>
<b>10.0 Parts subject to wear .....</b>	<b>42</b>
<b>EC-Type Examinations Certificate.....</b>	<b>43</b>
<b>Declarations of conformity .....</b>	<b>47</b>
<b>Test reports.....</b>	<b>51</b>

---

## 1.0 The EX-TEC® SR5, SR4, SR2 and VARIOTEC® 8 models

This family of detectors consists of a total of four combined detectors for the following uses:

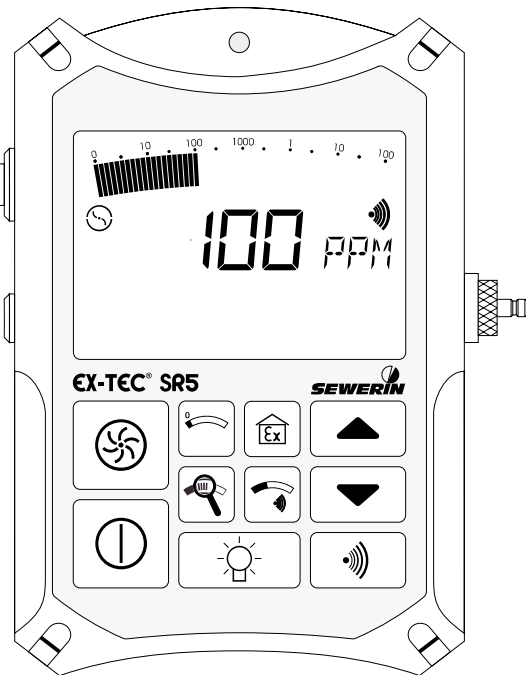

### EX-TEC® SR5 (Ex-protected)

- **Gas detection**  
above-ground gas detection for pipeline monitoring (ppm range)
- **Interior installations**  
leak detection for pipelines in buildings (ppm range)
- **Workplace monitoring**  
monitoring proximity to the Lower Explosive Limit (%LEL range)
- **Location**  
concentration measurement in probe holes (vol.% range)
- **Gasing and inertisation**  
concentration measurement in pipelines (vol.% range)

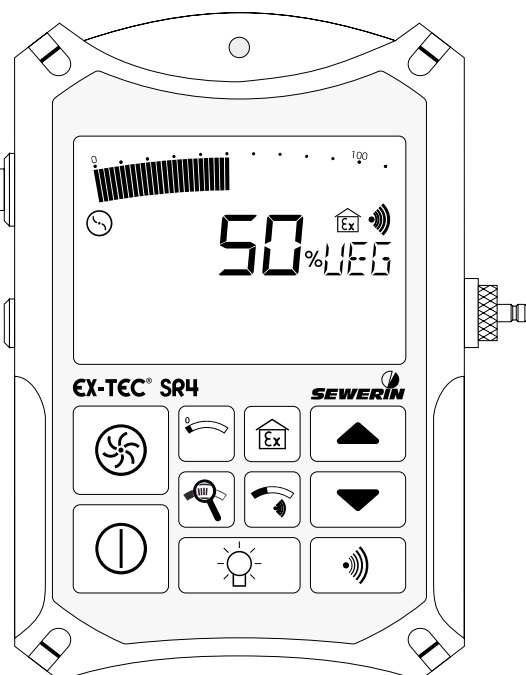

### EX-TEC® SR4 (Ex-protected)

- **Workplace monitoring**  
monitoring proximity to the Lower Explosive Limit (%LEL range)
- **Location**  
concentration measurement in probe holes (vol.% range)
- **Gasing and inertisation**  
concentration measurement in pipelines (vol.% range)



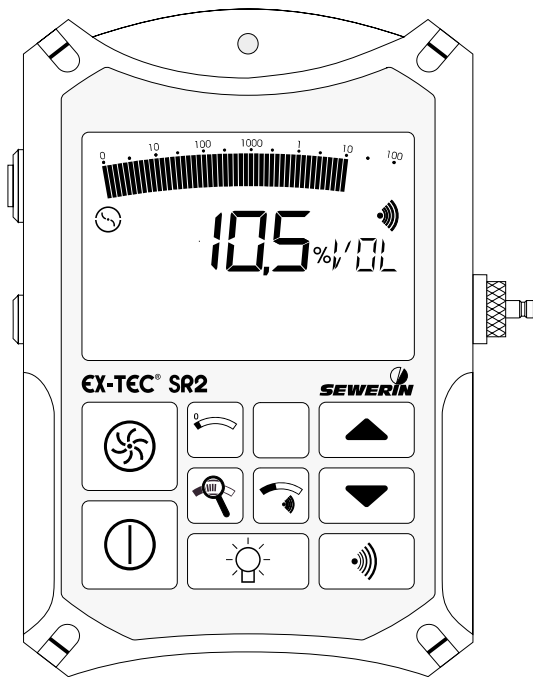

### EX-TEC® SR2 (Ex-protected)

- **Location**  
concentration measurement in probe holes (vol.% range)
- **Gasing and inertisation**  
concentration measurement in pipelines (vol.% range)

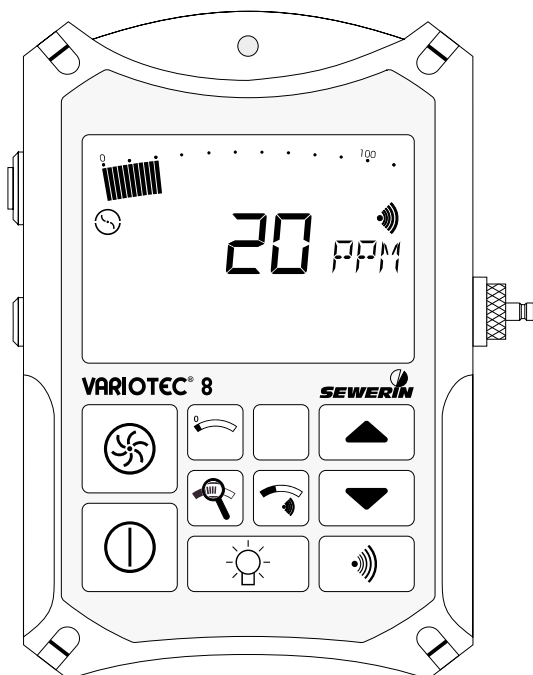

### VARIOTEC® 8

- **Gas detection**  
above-ground gas detection for pipeline monitoring (ppm range)
- **Location**  
concentration measurement in probe holes (vol.% range)

## 1.1 Tests

### **Passive explosion protection**

The **EX-TEC® SR5**, **EX-TEC® SR4** and **EX-TEC® SR2** models are explosion-proof in accordance with European norms (CENELEC):

EC prototype test certificate: PTB 96 ATEX 2166  
Classification: Ⓔ II 2 G EEx ib d IIB T4  
Test institute: Physikalische-Technische  
Bundesanstalt, Braunschweig

### **Active explosion protection**

The **EX-TEC® SR5** and **EX-TEC® SR4** have also been tested for functional safety in the Workplace Monitoring (WPM) field:

Test report: PFG no. 41300897  
Test institute: DMT-Gesellschaft für Forschung  
und Prüfung mbH, Essen

The test certificates can be found on and after page 43.

## 1.2 Probe systems

### - Probes for the survey of gas distributions networks -

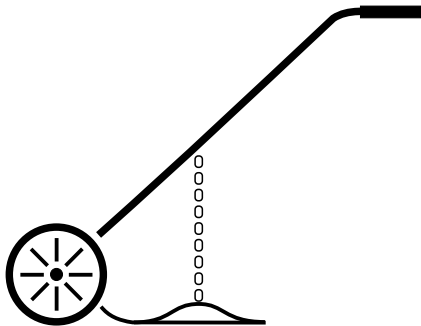

#### **Carpet probe**

for checking stable surfaces.  
The sample is drawn into an excrescence in a neoprene mat in contact with the surface with no extraneous emissions.

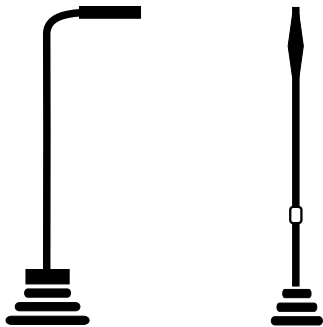

#### **Bell probe, telescopic bell probe**

for checking unstable and overgrown surfaces.  
It can be used in confined spaces, e.g. between parked cars or in front gardens.

### - Probes for localisation -



#### **Search probe**

for measuring concentrations in probe holes,  
with a rigid rubber cone to seal off the probe hole,  
2 different probe tips (length 245 mm or 345 mm),  
carbon-dioxide filter to filter out traces of CO<sub>2</sub>

## - Probes for hollow spaces -

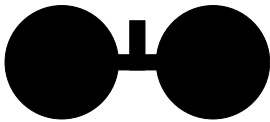

### **Floating probe**

for measuring concentrations in pits,  
with suction vent and hose  
connection

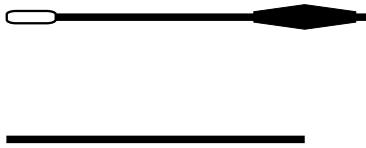

### **Divisible handprobe**

for the detection of leaks in pipes  
installed in poorly accessible places,  
measuring of concentration in con-  
tainers, overall length 900 mm

## - Probes for house service lines -

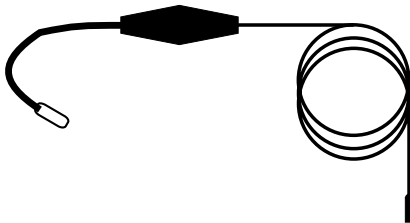

### **Flexible hand probes**

for the detection of leaks in  
house service lines, handle with  
flexible swan neck and probe  
hose, overall lengths 360 mm or  
660 mm



**Except with the carpet probe , a probe hose  
should always be used with a hydrophobic filter !**

## 2.0 Measuring operation



**Please fold out the illustration inside the front cover !**

<u>Item</u>	<u>Description</u>	<u>Function</u>
1	alarm lamp	optical warning when alarm thresholds are exceeded
2	LCD display	display of gas concentrations and operating conditions
3	probe connection	connection to the probes described
4	buttonboard	operating the detector
5	harness	for portable systems
6	outlet	for gas sample
7	buzzer	acoustic warning when alarm thresholds are exceeded

## 2.1 Switching on

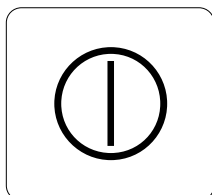

- press the **on/off button** (gas-detection mode) or **WPM button** (workplace-monitoring mode, p. 16 ff.) for approx. 2 seconds
- optical and acoustic control signal (items 1 and 7) operate for approx. 2 seconds

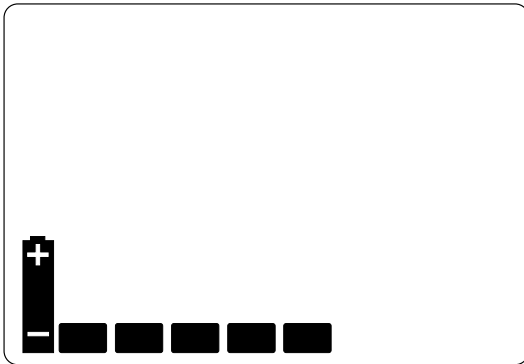

- display of available operating hours in the form of bars (e.g. 5 hours)
- the integral pump operates at maximum power

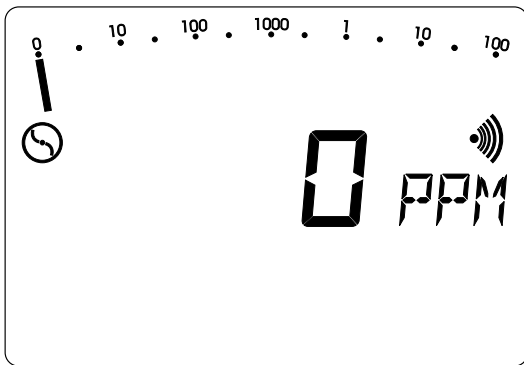

- wait until the zero point has established itself in fresh air (approx. 2-3 minutes):

**EX-TEC® SR5** and **VARIOTEC® 8**:

 **0 PPM**

(after flashing stops)

**EX-TEC® SR4** and **EX-TEC® SR2**:

 **0,0 %VOL**

## 2.2 Illumination and contrast

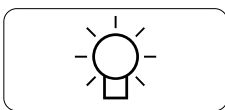

- pressing the **light button** switches the LCD illumination on and off

- the illumination automatically switches off approx. 4 minutes after being switched on

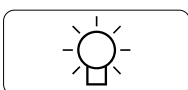

- simultaneously pressing the light button **and** a cursor button increases or reduces the contrast of the LCD display

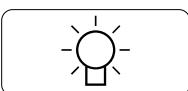

## 2.3 Pump operation

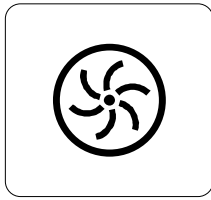

- pressing the **pump button** switches the pump on and off

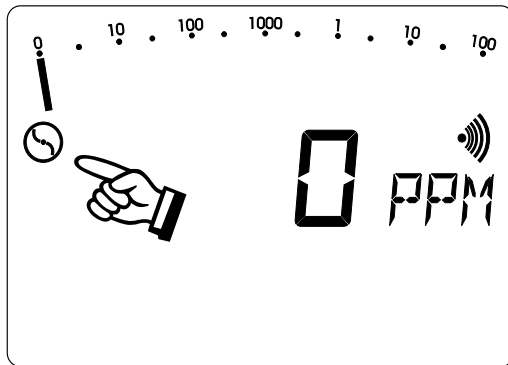

- the corresponding symbol appears in or disappears from the LCD display (item 2)
- this enables the pump function to be checked



### **Altering the pump power**

**(available only on the EX-TEC® SR5) !**

- simultaneously pressing the pump button **and** one cursor button increases or reduces the pump power

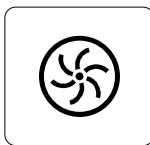

### **gas detection**

for above-ground gas detection (pipeline monitoring) always use **maximum pump power**

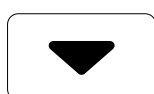

### **house service lines**

for detecting leaks in pipelines inside buildings always use **minimum pump power**

## 2.4 Alarm signal and volume

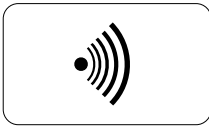

- pressing the **signal button** switches the alarm signal on and off

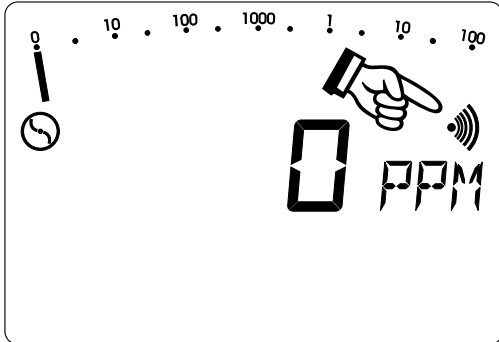

- the corresponding symbol appears in or disappears from the LCD display (item 2)
- this enables the alarm signal to be checked



- simultaneously pressing the signal button **and** one cursor button increases or reduces the buzzer volume (item 7)

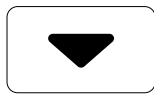

## 2.5 Alarm threshold value



- when the **threshold value button** is held down

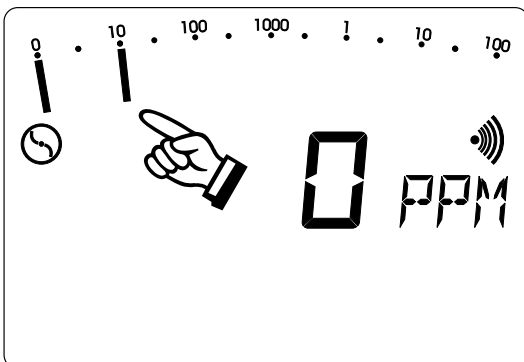

- the alarm threshold value (e.g. 10 PPM) flashes in the full-range display





- holding down the threshold value button **and** repeatedly pressing one cursor button increases or reduces the alarm threshold value
- this value is preserved even when the detector is switched off

## 2.6 Switching measuring ranges

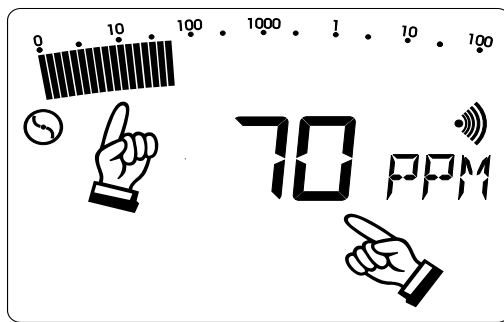

- all detectors have an **analogue display** (above, full range) **and** a **digital display** (below); both scales indicate the same concentration (e.g. 70 PPM)

- the **full range** is a logarithmic scale covering the range: 0 PPM ... 100 %VOL

- here the display of low concentrations is intensified; the measurement result can be read off from the digital display



- repeatedly pressing the **zoom button** switches between the **full** and **optimum ranges**

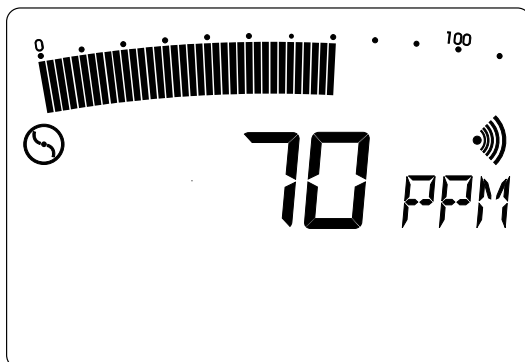

- depending on the concentration, switching between the following measurement ranges is **automatic**:

0 ... 10 PPM	0 ... 1 %VOL
0 ... 100 PPM	0 ... 10 %VOL
0 ... 1,000 PPM	0 ... 100 %VOL

- the optimum measurement range in this example is 0 ... 100 PPM

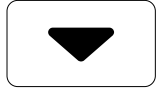
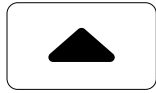

- repeatedly pressing one of the cursor buttons while holding down the zoom button switches manually to the required display range

## 2.7 Zero-point adjustment



- if the detector fails to reach its zero point of **0 PPM** or **0,0 %VOL** after flushing with copious fresh air, pressing the **zero point button** enables you to adjust it manually
- the reading display flashes while the adjustment is being carried out
- measurement cannot be resumed until **after** the flashing stops

## 2.8 Workplace monitoring



**This function is available only with the EX-TEC® SR5 and EX-TEC® SR4 detectors !**



- this function is switched on by pressing the **WPM** (workplace monitoring) **button**
- the detector can also be switched on by pressing this button

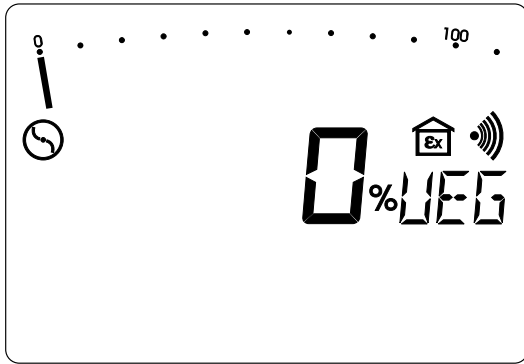

- this measuring range is used to monitor proximity to the **LEL** (**l**ower **e**xplosion **l**imit)
- after approx. 8 seconds' warm-up time a stable zero point is reached
- the pump runs at minimum power and the acoustic operating signal (item 7) sounds every 5 seconds

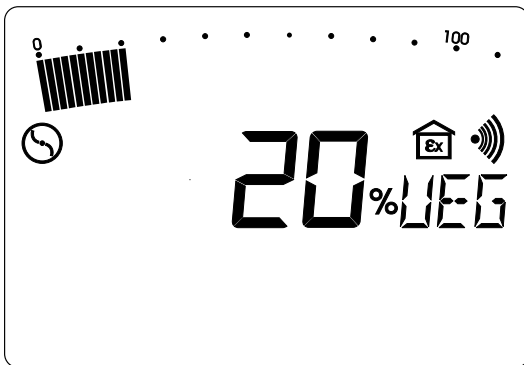

- when the pre-set threshold of 20 %LEL is exceeded
- methane:** 20 %LEL = 0,88 %VOL  
(display = 0,90 %VOL)
- propane:** 20 %LEL = 0,34 %VOL

the **advance alarm** is triggered both optically (item 1) and acoustically (item 7)

- the advance alarm is an intermittent tone quite distinct from the operating signal; it **ceases after a certain period** and cannot be cleared

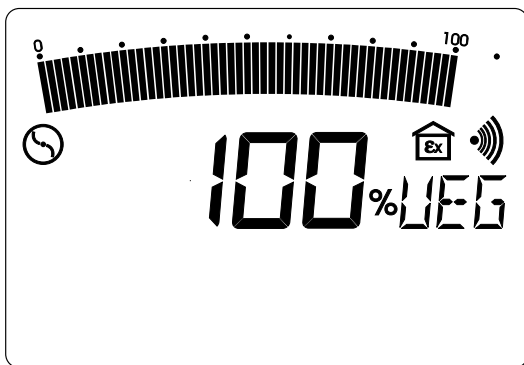

- if the concentration exceeds 100 %LEL
- methane:** 100 %LEL = 4,40 %VOL
- propane:** 100 %LEL = 1,70 %VOL

the **main alarm** is triggered optically (item 1) and acoustically (item 7)

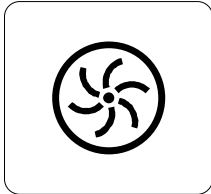

- the main alarm is a continuous tone quite distinct from the operating signal; it **continues indefinitely** and cannot be cleared
- **Cancelling the main alarm:** switch to location operation (press the pump button for approx. 2 seconds ) or switch the detector off

## 2.9 Battery alarm

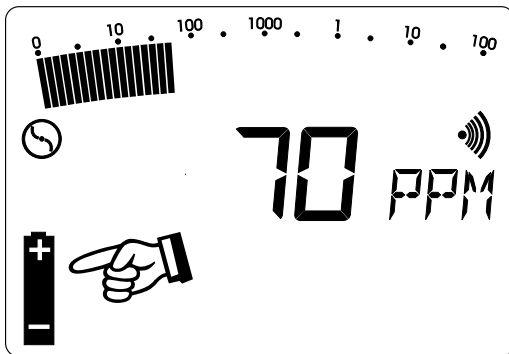

- if the battery symbol appears in the LCD display, at least 15 minutes' operating time remains; after that the detector must be recharged
- in workplace-monitoring mode the battery alarm is accompanied by a "double beep" to distinguish it from the operating signal

## 2.10 Switching off

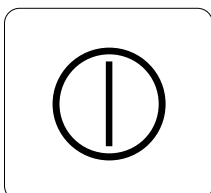

- Press the **on/off button** for approx. 2 seconds
- the optical and acoustic monitoring signals (items 1 and 7) operate for approx. 2 seconds
- remaining operating hours are displayed in the form of bars

### 3.0 Charging technique



**The EX-TEC® SR5, SR4, SR2 and VARIOTEC® 8 detectors must not be recharged in an explosive gas atmosphere !**

When fully charged the detectors have a **maximum** of 8 hours' operating time with the pump running.

For charging you need the **HS charging adapter** (see illustration), which can be used either in the workshop or in the standby vehicle.

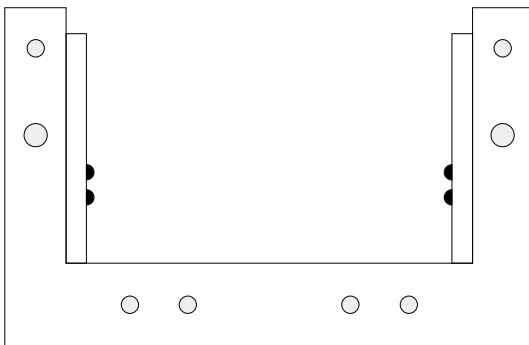

The following items can be connected to the side of the charging adapter:

- 230 V mains power pack ≈,
- 12 V= vehicle adapter,
- 24 V= vehicle adapter.

#### **Charging**

Switch the detector off and plug it into the charger. A display of the following type appears:

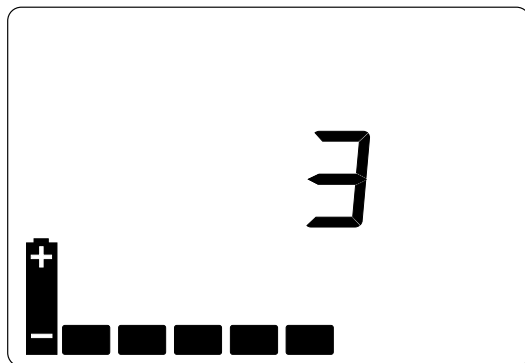

- the detector has 5 operating hours left (= 5 bars) and will take 3 hours to become fully charged
- if it is fully charged all the bars are visible and the number display disappears
- the detector can be left in the charger until it is next needed

## **Spontaneous discharge**

If the detector is not connected to the charger when switched off, the nickel-cadmium battery spontaneously discharges, thus reducing the available operating hours.

After a maximum of 30 days the detector indicator shows that there are no operating hours left, and it must be recharged.



**Short periods of operation and prolonged disuse may lead in the long term to the so-called "memory effect", in which the display indicates a higher battery capacity than is actually available. This can be avoided by fully discharging -the detector regularly (e.g. once a month), leaving it switched on until it automatically switches off, then recharging it!**

## 4.0 Inspection, testing and maintenance

DVGW work sheet G 465/IV requires detectors to be inspected, tested and maintained.

### **Sensitivity testing**

may be necessary several times a day, according to G 465/I, depending on the circumstances - particularly with gas detectors used to monitor mains pipes.

### **Inspection**

must be carried out up to six times a year, depending on frequency of use - and at any rate at least once a year. The following items must be tested:

- detector condition
- battery condition
- intake channel
- pump power
- zero point
- sensitivity (with test gas)



### **Workplace monitoring mode:**

**For your own safety you are recommended always to check the %LEL range with test gas before use and recalibrate if necessary (instruction sheet T 031 / BG Chemie) !**

### **Test report**

Test results must be recorded. A specimen form will be found on the last page of this manual.

### **Servicing and maintenance**

DVGW work sheet G 465/IV specifies that servicing and maintenance of the detectors may be carried out only by the following persons:

- the SEWERIN Service Department or
- an expert authorised by SEWERIN.

Servicing must be carried out at least once a year. The next scheduled date must be entered on the inspection sticker attached to the detector (month/year).

After servicing a certificate must be completed.

## 4.1 Test sets

Pump power, zero point and sensitivity should be tested with an **SPE 1** or **SPE 3** test set and a suitable test gas:

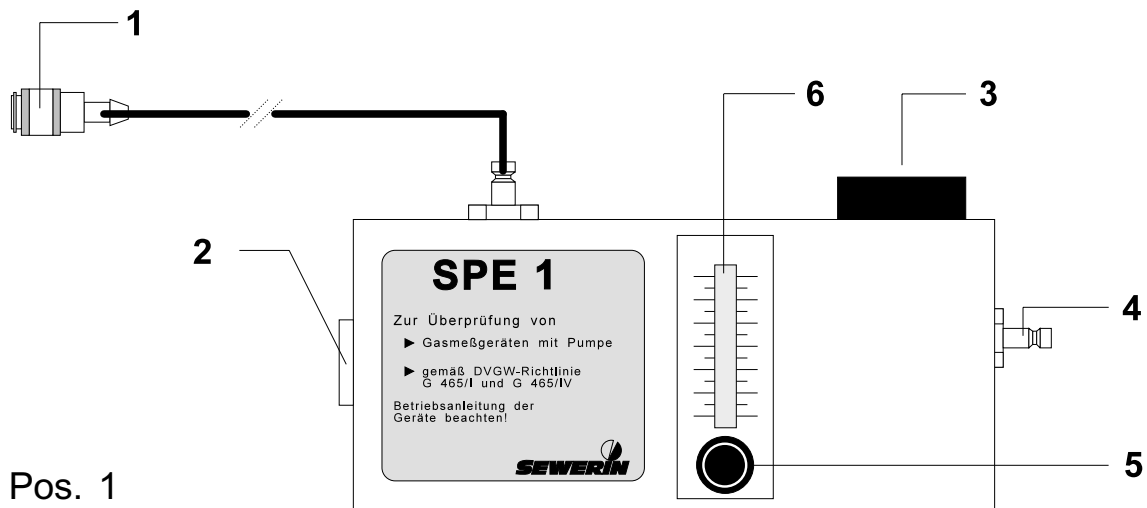

**SPE 1** test set, used to test:

- pump power
- zero point in the **%LEL and %VOL range**
- sensitivity in the **%LEL and %VOL range**

and for use with the following test gases:

- |   |   |
|---|---|
| methane CH <sub>4</sub> :               | <ul style="list-style-type: none"><li>• 1.00 vol.%</li><li>• 2.20 vol.% (50 %LEL)</li><li>• 100 vol.%</li></ul> |
| propane C <sub>3</sub> H <sub>8</sub> : | <ul style="list-style-type: none"><li>• 1.00 vol.% (59 %LEL)</li><li>• 100 vol.%</li></ul>                      |



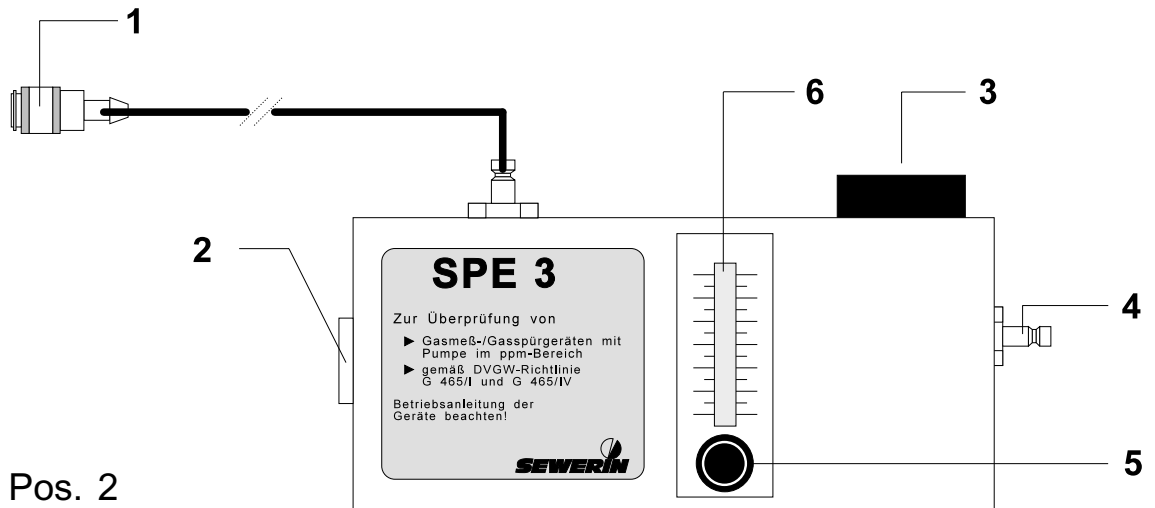

**SPE 3** test set, used to test:

- pump power
- zero point in the **PPM range**
- sensitivity in the **PPM range**

and for use with the following test gases:

- methane CH<sub>4</sub>:
- 10 ppm
  - 100 ppm
  - 1,000 ppm

## 4.2 Test gases

The following test gases were used to function-test the detectors:

		methane CH <sub>4</sub>	propane C <sub>3</sub> H <sub>8</sub>
<b>EX-TEC® SR5</b>	ppm range	10 ppm CH <sub>4</sub> 100 ppm CH <sub>4</sub> 1,000 ppm CH <sub>4</sub> 1.00 vol.% CH <sub>4</sub>	
	%LEL range	2.20 vol.% (50 %LEL)	1.00 vol.% (59 %LEL)
	vol.% range	100 vol.% or location natural gas	100 vol.%
<b>EX-TEC® SR4</b>	%LEL range	2.20 vol.% (50 %LEL)	1.00 vol.% (59 %LEL)
	vol.% range	100 vol.% or location natural gas	100 vol.%
<b>EX-TEC® SR2</b>	vol.% range	100 vol.% or location natural gas	100 vol.%
<b>VARIOTEC® 8</b>	ppm range	10 ppm CH <sub>4</sub> 100 ppm CH <sub>4</sub> 1,000 ppm CH <sub>4</sub> 1.00 vol.% CH <sub>4</sub>	
	vol.% range	100 vol.% or location natural gas	100 vol.%

For detector settings other than methane or propane the correct values can be found inside the cover on page 2.

### 4.3 Function testing

Proceed as follows:

- screw the selected test-gas bottle onto the test set as far as it will go (illustration 1/2 - item 2)
- connect the detector's probe nipple (item 3) to the test set hose (illustration 1/2 - item 1)
- switch the detector on; the pump draws in **fresh air** through the test set (illustration 1/2 - item 4)
- use the needle valve (illustration 1/2 - item 5) to set the maximum flow; it must be > 50 l/h (illustration 1/2 - item 6)
- wait until a stable zero point has been established (warm-up time)
- press the release button (illustration 1/2 - item 3) on the test set and adjust the flow to the fresh-air value (illustration 1/2 - item 6)
- hold it down until the indicated concentration has reached a stable value

Admissible display values for methane CH<sub>4</sub> test gas:

- test gas 10 ppm : > 5 ppm
- test gas 100 ppm : 70 ... 140 ppm
- test gas 1,000 ppm : 800 ... 1,200 ppm
- test gas 1.00 vol.% : 0.80 ... 1.20 vol.%,
- test gas 2.20 vol.% : 2.00 ... 2.40 vol.% (45 - 55 %LEL)
- test gas 100 vol.% : 98 ... 102 vol.%

Admissible display values for propane C<sub>3</sub>H<sub>8</sub> test gas:

- test gas 1.00 vol.% : 0.90 ... 1.10 vol.% (55 - 64 %LEL)
- test gas 100 vol.% : 98 ... 102 vol.%

If display values are outside these tolerances the detector must be recalibrated (section 5.0 Adjustment).

## 5.0 Adjustment

**EX-TEC® SR5, SR4, SR2** and **VARIOTEC® 8** detectors are factory-set for all measuring ranges.

You can adjust each of the ranges using appropriate test gases (one for each range).



**All the following adjustment steps are shown on an EX-TEC® SR5 detector; they are identical for all other models !**

### Testing procedure

Connect your detector (switched off) to the **SPE 1** or **SPE 3** test set and a test gas .

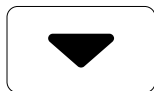
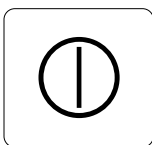

- now press these 3 buttons simultaneously

### Display 1 - version number / zero point

Once the number of available operating hours has been displayed the detector is in **adjustment mode**:

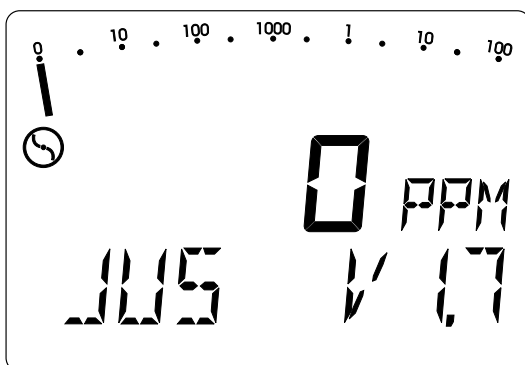

- the software version number (e.g. V1.0) is displayed and the pump runs at maximum power
- the reading display flashes until the zero point of the sensor has been automatically established



- once the zero point has been set, press the cursor-up button to move to the next display

### **Display 2 - 10 ppm adjustment**

Now release the **10 ppm methane CH<sub>4</sub> test gas** from the **SPE 3** test set.

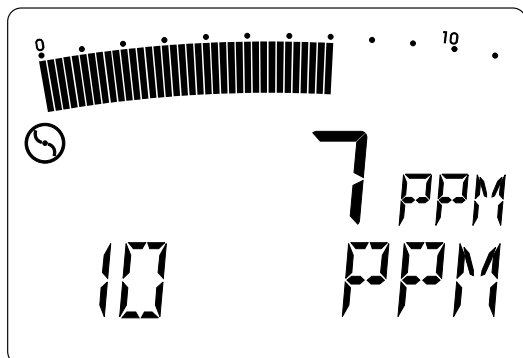

- wait until the display has stabilised
- confirm the adjustment with the on/off button (**OK** appears in the LCD display)
- turn off the test-gas feed



- press the cursor-up button to move to the next display

### **Display 3 - 100 ppm adjustment**

Now release the **100 ppm methane CH<sub>4</sub> test gas** from the **SPE 3** test set.

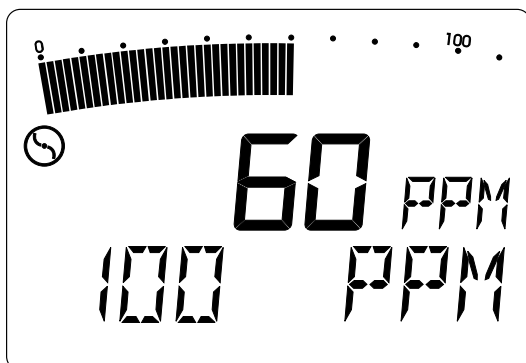

- wait until the display has stabilised
- confirm the adjustment with the on/off button (**OK** appears in the LCD display)
- turn off the test-gas feed



- press the cursor-up button to move to the next display

#### **Display 4 - 1,000 ppm adjustment**

Now release the **1,000 ppm methane CH<sub>4</sub> test gas** from the **SPE 3** test set.

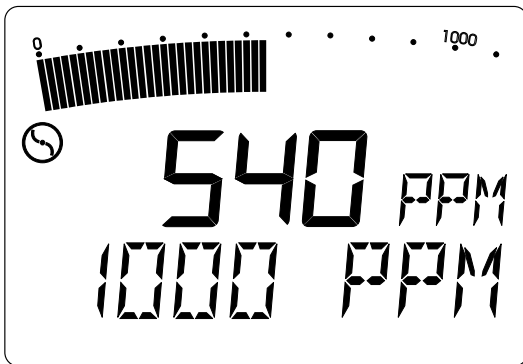

- wait until the display has stabilised
- confirm the adjustment with the on/off button (**OK** appears in the LCD display)
- turn off the test-gas feed



- press the cursor-up button to move to the next display



**NB: change the test set !**

#### **Display 5 - 1.00 vol.% adjustment**

Now release the **1.00 vol.% methane CH<sub>4</sub> test gas** from the **SPE 1** test set.

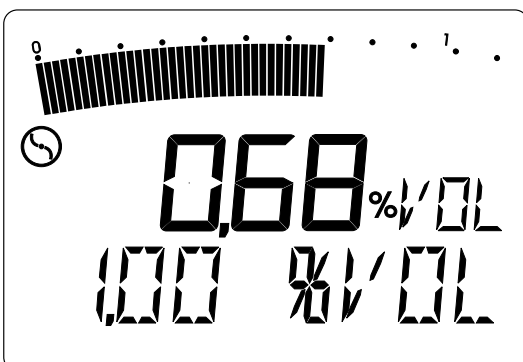

- wait until the display has stabilised
- confirm the adjustment with the on/off button (**OK** appears in the LCD display)
- turn off the test-gas feed



- press the cursor-up button to move to the next display

### **Display 6 - 0 %LEL adjustment**

Now set the zero point of the %LEL range with **fresh air** using the **SPE 1** test set.

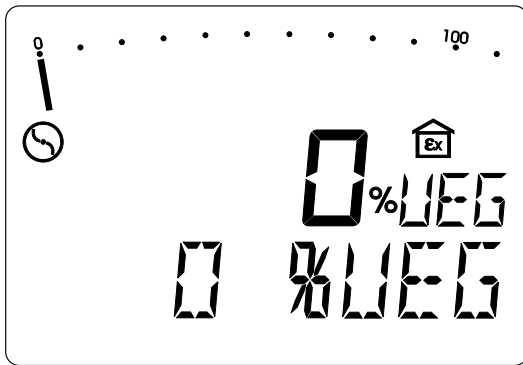

- wait until the display has stabilised
- confirm the adjustment with the on/off button (**OK** appears in the LCD display)



- press the cursor-up button to move to the next display

### **Display 7 - 50 %LEL or 59 %LEL adjustment**

Now release:

**2.20 vol.% methane CH<sub>4</sub> test gas = 50 %LEL** or  
**1.00 vol.% propane C<sub>3</sub>H<sub>8</sub> test gas = 59 %LEL**

via the **SPE 1** test set.

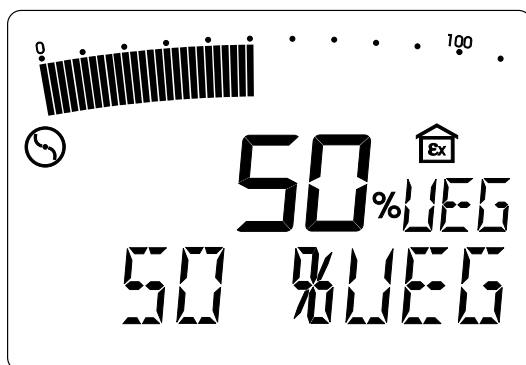

- wait until the display has stabilised
- confirm the adjustment with the on/off button (**OK** appears in the LCD display)
- turn off the test-gas feed



- press the cursor-up button to move to the next display

### **Display 8 - 0 vol.% adjustment**

Now set the zero point of the vol.% range with **fresh air** using the **SPE 1** test set.

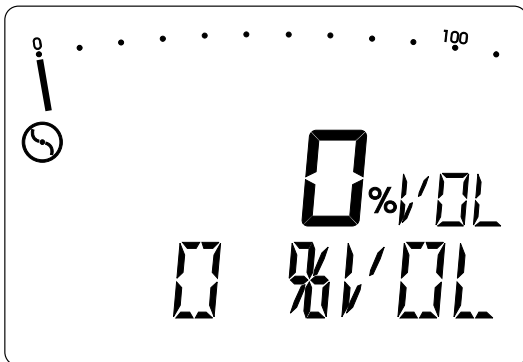

- wait until the display has stabilised
- confirm the adjustment with the on/off button (**OK** appears in the LCD display)



- press the cursor-up button to move to the next display

### **Display 9 - 100 vol.% adjustment**

Now release the

**100 vol.% methane CH<sub>4</sub>** or  
**100 vol.% propane C<sub>3</sub>H<sub>8</sub>** test gas

via the **SPE 1** test set. This requires a steel test-gas bottle with pressure reducer and connecting hose.

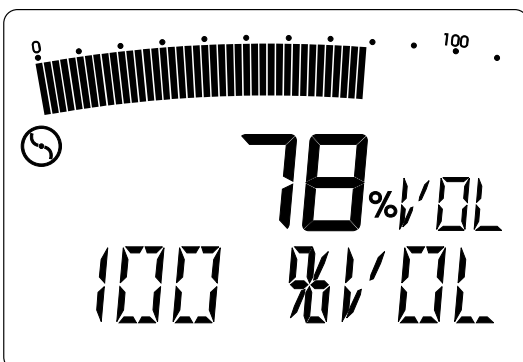

- wait until the display has stabilised
- confirm the adjustment with the on/off button (**OK** appears in the LCD display)
- turn off the test-gas feed



- press the cursor-up button to move to the next display



You can also set the detector to your local natural gas:

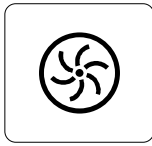

- switch the pump off
- admit the natural gas directly to the detector (not via the test set) and wait for the display to reach a stable value
- confirm the adjustment with the on/off button (**OK** appears in the LCD display) and switch the pump on again



- press the cursor-up button to move to the next display

### **Display 10 - %LEL range language**

Repeatedly pressing the on/off button enables you to select among the following displays in the %LEL range:

- |             |   |   |
|-------------|---|---|
| <b>%UEG</b> | - | <b>U</b> ntere <b>E</b> xplosions <b>g</b> renze (German)       |
| <b>%LEL</b> | - | <b>L</b> ower <b>E</b> xplosive <b>L</b> imit (English)         |
| <b>%LIE</b> | - | <b>L</b> imite <b>I</b> nférieure d' <b>E</b> xplosion (French) |
| <b>%VOL</b> | - | concentration display in vol.% (German/English)                 |
| <b>%GAZ</b> | - | concentration display in vol.% (French)                         |

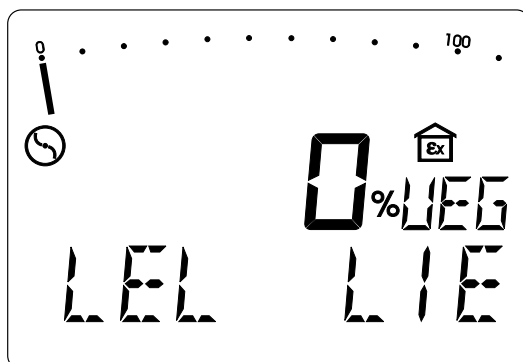

- confirm the display e.g. **%UEG** with the on/off button (**OK** appears in the LCD display)
- this display is retained even when the detector is switched off



- press the cursor-up button to move to the next display

### **Display 11 - %VOL range language**

By repeatedly pressing the on/off button you can choose between the following displays in the vol.% range:

- %VOL** - concentration display in vol.% (German/English)
- %GAZ** - concentration display in vol.% (French)

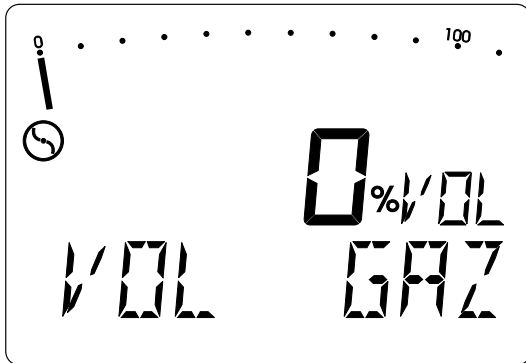

- confirm the display, e.g. **%VOL**, with the on/off button (**OK** appears in the LCD display)
- this setting is retained even when the detector is switched off



- press the cursor-up button to move to the next display

### **Display 12 - 10 PPM sensitivity**

Synthetic or fresh air is used for the zero-point adjustment, you must always achieve sensitivity of > 5 ppm when using 10 ppm methane CH<sub>4</sub> test gas.

To this end you can select from the following amplification ratios in the 10 ppm range by repeatedly pressing the on/off switch:

- 1,0 x 10 PPM** - 100% amplification
- 1,2 x 10 PPM** - 120% amplification
- 1,5 x 10 PPM** - 150% amplification (factory setting)

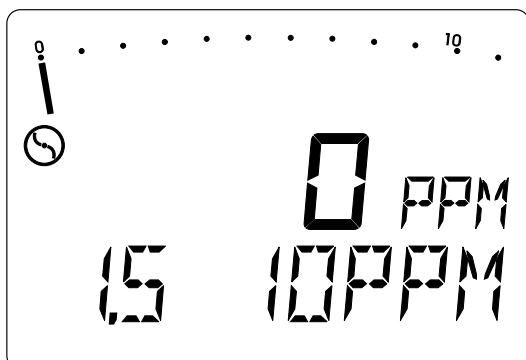

- confirm the selected amplification (e.g. **1,5 x 10 PPM**) with the on/off button

### **Display 13 - LCD check**

With this function you can check whether all elements of the LCD display are operating normally.

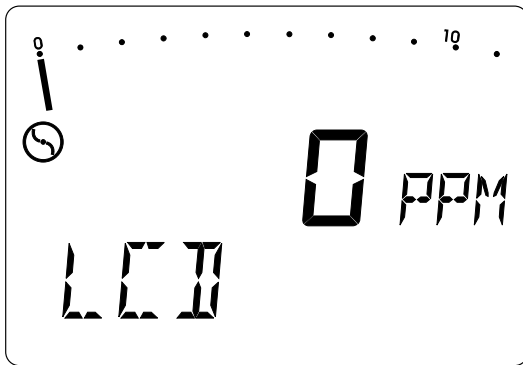

- confirm the LCD check with the on/off button



- press the cursor-up button to return to the first display

### **Leaving adjustment mode**

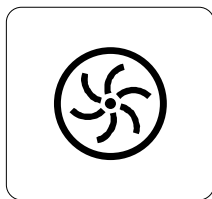

- press the pump button to return to **gas-detection mode** or



- press the WPM button to return to **workplace-monitoring mode** or

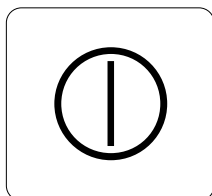

- press the on/off button to switch the detector off.

## 6.0 Technical specifications

### Maximum pointer

To facilitate the comparison of different gas concentrations, the maximum value is displayed by a flashing **maximum pointer**.

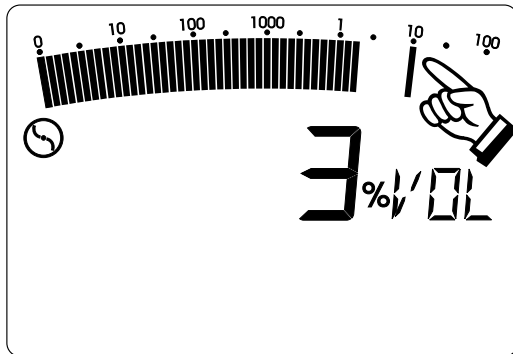

- this remains in the LCD display (item 2) for about 4 minutes unless updated by a higher concentration
- pressing the zoom button makes the maximum pointer disappear

### Heavy gas

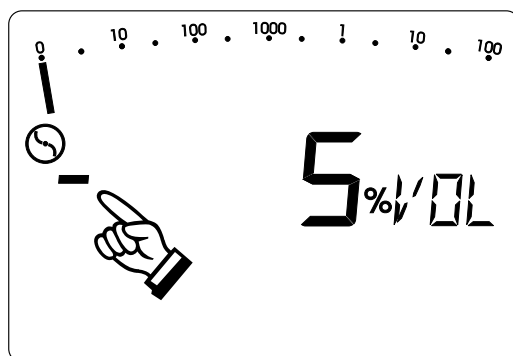

- a negative sign in the measuring-value display indicates a mixture of light and heavy gas in which the heavy gas (e.g. propane  $C_3H_8$  or carbon dioxide  $CO_2$ ) predominates.
- if it is carbon dioxide, we recommend the use of a  $CO_2$  filter (accessories) to suppress this heavy-gas component

### Oxygen concentration

In order to guarantee electrical safety the detectors may not be used in an oxygen concentration exceeding 21 vol.%.

An oxygen deficiency may lead to deviations from the correct reading. At oxygen concentrations between 20.9 vol.% and 5 vol.% this deviation is less than 5 %.

## **Gasing and Inertisation**

To carry out gasing (concentration increase to 100 vol.%) or inertisation (concentration reduction to 0 vol.%) proceed as follows:

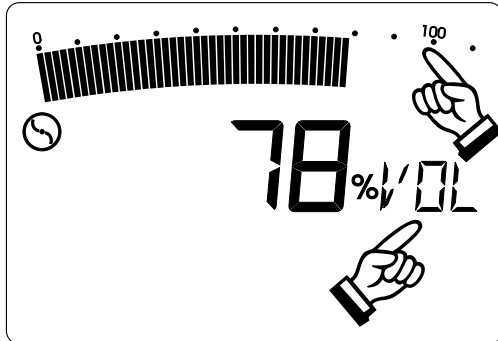

- manually select the **0...100 %VOL measuring range** with the zoom button and the cursor buttons
- this is the only measuring range in which gasing and inertisation can be unambiguously monitored

## **Automatic alarm reset**



- if the signal button has been pressed to deactivate an alarm, the alarm signal is automatically reset after approx. 60 seconds

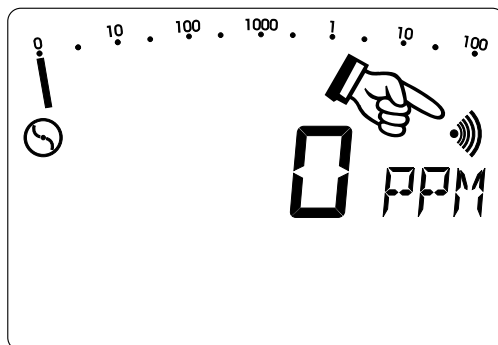

- the corresponding symbol reappears in the LCD display (item 2)
- this is intended to stop you forgetting that the alarm signal has gone off

## **Cleaning**

Clean the detectors only with a damp cloth. No solvents, benzenes or similar substances may be used !

## **Static charging**

Generally speaking electrostatic charging should be avoided. Objects with no electrostatic earth (including, for example, metallic housings with no earth connection) are not protected from charges resulting from dust, vapour flows and the like.

## **Fine dust filters**

There are fine dust filters in the screw-on probe connector (item 3) and in most probes.

The filters can be cleaned by tapping or blowing to remove the dust.



**After cleaning the filters must be replaced in the same position as before !**

**Heavily-soiled filters should be replaced by new ones (accessories) !**

## **Sensor sensitivity**

The sensors are deleteriously affected by gaseous components of silicones, oils and phosphate esters, which irreversibly reduce their sensitivity.

Pollution of the measuring environment by halogens, burnt neoprene, PVC, trichloroethylene and the like also weakens the sensitivity of the sensors, but in this case it can be regenerated.

## **Operation hours during measuring time**

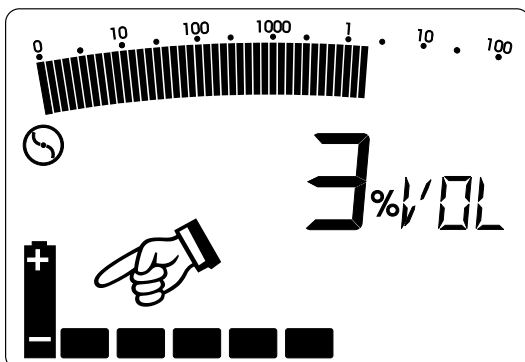

- simultaneously pressing both cursor buttons in the detection mode displays the remaining operating time (e.g. 5 hours)
- display disappears (battery symbol and bars) automatically after approx. 10 seconds.

## 7.0 Technical data

<b>Models</b>	:	<b>EX-TEC® SR5, EX-TEC® SR4, EX-TEC® SR2, VARIOTEC® 8</b>
<b>Calibration</b>	:	methane CH <sub>4</sub> / natural gas, propane C <sub>3</sub> H <sub>8</sub>
<b>Measuring systems</b>		
- PPM range	:	semiconductor sensor
- %LEL range	:	thermal combustion sensor
- %VOL range	:	thermal conductivity sensor
<b>Measuring ranges</b>	:	10 ppm - 1 ppm steps 100 ppm - 2 ppm steps 1,000 ppm - 20 ppm steps 1 vol.% - 0.02 vol.% steps 10 vol.% - 0.1 vol.% steps 100 vol.% - 1 vol.% steps 100 %LEL - 1 %LEL steps
<b>Workplace monitoring</b>		
- measuring system	:	thermal combustion sensor
- t <sub>90</sub> time	:	≤ 4 seconds
<b>Pump power</b>		
- gas detection / location	:	> 50 l/h and >150 mbar
- workplace monitoring	:	> 35 l/h
<b>Ex-protection (CENELEC)</b>		
- test institute	:	Physikalisch-Technische Bundesanstalt, Braunschweig
- Certificate No.	:	Ex-96.ATEX.2166
- Classification	:	Ⓔ II 2 G EEx ib d IIB T4

<b>Alarm thresholds</b>	:	4 ppm or 2 vol.% (variable), 20 %LEL (fixed)
<b>Dimensions (W x H x D)</b>	:	129 x 192 x 65 mm
<b>Weight</b>	:	1500 g
<b>Type of protection</b>	:	IP 54
<b>Operating time</b>	:	max. 8 hours
<b>Power supply</b>	:	NiCd battery, rechargeable
<b>Operating temperature</b>	:	-10° to +40° Celsius
<b>Storage temperature</b>	:	-25° to +70° Celsius
<b>Humidity range</b>	:	5 - 90 % relative humidity (non-condensing)
<b>Pressure range</b>	:	900 h Pa to 1100 h Pa



## 8.0 Accessories

<i>CHARGING TECHNIQUE</i>	HS charging adapter, 230 V mains power pack, 12 V or 24 V vehicle adapter
<i>PROBE SYSTEMS</i>	for pipeline monitoring, location, space monitoring and interior installations (see section 1.2)
<i>PROBE HOSE</i>	with hydrophobic filter and quick- release fastenings, in lengths of 1 m, 2 m and 6 m
<i>CO<sub>2</sub> FILTER</i>	to filter out carbon-dioxide traces in the sample gas
<i>PLUNGER BAR</i>	for making probe holes manually handle insulated to 10 kV working lengths 625 mm, 1025 mm and 1325 mm
<i>TEST SETS</i>	<b>SPE 1</b> and <b>SPE 3</b> for mobile use (e.g. in a vehicle) with test- gas bottles, <b>SPE 2</b> for stationary use in the workshop with test-gas flasks
<i>TEST GASES</i>	Test gases in various concentrations, in pressurised gas bottles or flasks
<i>CARRYING CASE</i>	with foam lining and compartments for accessories, detector can be charged in the case
<i>CARRYING SYSTEMS</i>	<b>Triangle carrying system:</b> neck-strap and pad, <b>Cross-strap carrying system:</b> 2 cross-straps

## 9.0 Error messages

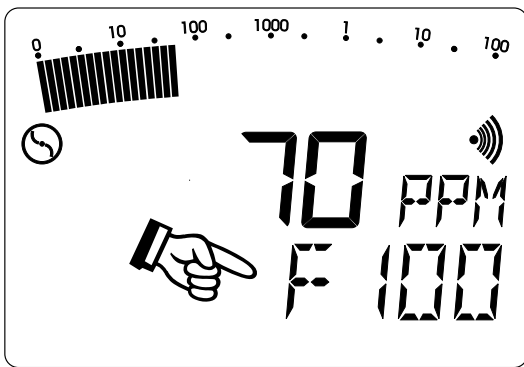

- the detectors automatically identify errors and show the error code in the LCD display (item 2)

### **Error code**

### **cause and remedy**

F10 - F14 .....	adjustment errors in the PPM range check test gas or repeat adjustment
F15, F16, F19, F20 ...	adjustment error in %VOL range, check test gas or repeat adjustment
F17, F18 .....	adjustment error in %LEL range, check test gas or repeat adjustment
F21 .....	component error can only be rectified by SEWERIN Service
F31 .....	synchronisation alarm (not clearable) in WPM mode, error due to nitrogen or carbon dioxide in the gas sample; switch off detector and switch on again in fresh air
F50 - F56 .....	component errors can only be rectified by SEWERIN Service

- F61 ..... sensor breakage in the thermal combustion sensor:  
contact SEWERIN service
- F62, F63 ..... sensor breakage in the thermal conductivity sensor: contact SEWERIN service
- F64 ..... sensor breakage in the flow sensor:  
contact SEWERIN service
- F65 ..... sensor breakage in the semiconductor sensor:  
contact SEWERIN service
- F66 ..... defective humidity sensor:  
contact SEWERIN service
- F100 ..... pump power too low:  
switch detector off and on again, inspect filters  
in detector and probes



**Should any other error codes occur, please contact SEWERIN service !**

## 10.0 Wearing parts

<i>FINE DUST FILTER</i>	in the probe connection of the detectors (item 3) and in most probes
<i>HOSE FILTER</i>	in the carpet probe
<i>PROBE FILTER INSERT</i>	in the bell probe and the gas-detection probe
<i>HYDROPHOBIC FILTERS</i>	in the 1m, 2m and 6m probe hoses
<i>NEOPRENE MAT</i>	for the carpet probe
<i>SODA LIME FLASK</i>	to refill the CO <sub>2</sub> filter
<i>TEST GAS CAN</i>	various concentrations in synthetic air or nitrogen <i>Caution!</i> <i>The can is pressurized: do not store at temperatures above 50° C.</i>

# EC-Type Examination Certificate

## Physikalisch-Technische Bundesanstalt

Braunschweig und Berlin



(1) **EC-Type Examination Certificate**  
(Translation)

(2) Equipment or Protective Systems Intended for use in  
Potentially Explosive Atmospheres - **Directive 94/9/EC**

(3) EC-Type Examination Certificate Number:

**PTB 96 ATEX 2166**



(4) **Equipment:** Gas detector / gas analyzer type 041 yy xxxx ... 044 yy xxxx

(5) **Manufacturer:** Hermann Sewerin GmbH

(6) **Address:** Robert-Bosch-Straße 3, D-33334 Gütersloh

(7) This equipment and any acceptable variation thereto is specified in the schedule to this certificate and the documents therein referred to.

(8) The Physikalisch-Technische Bundesanstalt, notified body No. 0102 in accordance with Article 9 of the Council Directive 94/9/EC of 23 March 1994, certifies that this equipment has been found to comply with the Essential Health and Safety Requirements relating to the design and construction of equipment and protective systems intended for use in potentially explosive atmospheres, given in Annex II to the Directive.

The examination and test results are recorded in a confidential report No. PTB Ex 96/2/0081.

(9) Compliance with the Essential Health and Safety Requirements has been assured by compliance with:

**DIN EN 50014:1994-03      DIN EN 50018:1995-03      DIN EN 50020:1996-04**

(10) If the sign „X“ is placed after the certificate number, it indicates that the equipment is subject to special conditions for safe use specified in the schedule to this certificate.

(11) This EC-Type Examination Certificate relates only to the design and construction of the specified equipment in accordance with Directive 94/9/EC. Further requirements of this apply to the manufacture and supply of this equipment.

(12) The marking of the equipment shall include the following:

II 2 G    EEx ib d IIB T4

Zertifizierungsstelle Explosionschutz

Braunschweig, 08.01.1997

By order

Dr.-Ing. U. Johannsmeyer  
Oberregierungsrat



Sheet 1/2

EC-Type Examination Certificates without signature and official stamp shall not be valid. The certificates may be circulated only without alteration. Extracts or alterations are subject to approval by the Physikalisch-Technische Bundesanstalt. In case of dispute, the German text shall prevail.

Physikalisch-Technische Bundesanstalt • Bundesallee 100 • D-38116 Braunschweig

# EC-Type Examination Certificate

**Physikalisch-Technische Bundesanstalt**  
Braunschweig und Berlin



## Schedule

(13)

(14) **EC-Type Examination Certificate No. PTB 96 ATEX 2166**

(15) Description of equipment

The apparatus is used to detect concentrations of gas, preferably methane within the range from 10ppm to 100 %. The incorporated pump delivers the measuring gas.

(16) Report No. PTB Ex 96/2/0081 (consisting of 3 pages and 27 drawings)

(17) Special Conditions for safe use

not applicable

(18) Essential Health and Safety Requirements

not applicable

(19) Warning lable

The battery may be changed and charged outside of the explosion hazardous area only.

Zertifizierungsstelle Explosionsschutz  
By order

Braunschweig, 08.01.1997

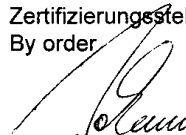
  
Dr.-Ing. U. Johannmeyer  
Oberregierungsrat



Sheet 2/2

EC-Type Examination Certificates without signature and official stamp shall not be valid. The certificates may be circulated only without alteration. Extracts or alterations are subject to approval by the Physikalisch-Technische Bundesanstalt. In case of dispute, the German text shall prevail.

Physikalisch-Technische Bundesanstalt • Bundesallee 100 • D-38116 Braunschweig

# EC-Type Examination Certificate

**Physikalisch-Technische Bundesanstalt**  
Braunschweig und Berlin

**PIB**

## 1. ERGÄNZUNG

gemäß Richtlinie 94/9/EG Anhang III Ziffer 6

**zur EG-Baumusterprüfbescheinigung PTB 96 ATEX 2166**

Gerät: Gasmess-Gasspürgerät Typ 041 yy xxxx ... 044 yy xxxx  
Hersteller: Hermann Sewerin GmbH  
Anschrift: Robert-Bosch-Straße 3  
D-33334 Gütersloh

### Beschreibung der Ergänzungen und Änderungen

1. Die Sensorkammer des oben genannten Gerätes darf künftig auch mit Sintermetallelementen als Atmungseinrichtung gefertigt werden.  
Technische Einzelheiten und Prüfergebnisse enthält der vertrauliche Prüfbericht Nr. PTB Ex 97-17045.
2. Werden die Gasmess-Gasspürgeräte mit einer Meßfunktion für den Explosionsschutz betrieben, ist gemäß Richtlinie 94/9/EG Anhang II Ziffer 1.5.5 bis 1.5.7 eine Funktionsprüfung erforderlich.  
Dies ist in geeigneter Form dem Betreiber mitzuteilen, z.B. in der Betriebsanleitung.

Prüfbericht Nr.: PTB Ex 97-17045

Zertifizierungsstelle Explosionsschutz

Braunschweig, 12.06.1997

Im Auftrag

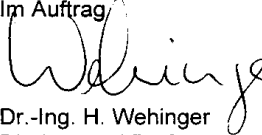
  
Dr.-Ing. H. Wehinger  
Direktor und Professor



Seite 1/1

---

EG-Baumusterprüfbescheinigungen ohne Unterschrift und ohne Siegel haben keine Gültigkeit.  
Diese EG-Baumusterprüfbescheinigung darf nur unverändert weiterverbreitet werden.  
Auszüge oder Änderungen bedürfen der Genehmigung der Physikalisch-Technischen Bundesanstalt.

Physikalisch-Technische Bundesanstalt • Bundesallee 100 • D-38116 Braunschweig

# EC-Type Examination Certificate

**Physikalisch-Technische Bundesanstalt**  
Braunschweig und Berlin



**2nd S U P P L E M E N T**  
according to Directive 94/9/EC Annex III letter 6  
to EC-type-examination Certificate PTB 96 ATEX 2166  
(Translation)

Equipment: Gas detector / gas analyzer type 041 yy xxxx ... 044 yy xxxx

Manufacturer: Hermann Sewerin GmbH

Address: Robert-Bosch-Straße 3  
D-33334 Gütersloh

Description of supplements and modifications

In accordance with Directive 94/9/EC, Annex II, letter 1.5 "Safety Devices", the data output and/or alarm of the gas detector / gas analyzer of types 041 11 xxxx, 041 12 xxxx, 042 11 xxxx and 042 12 xxxx can also be used to initiate safety-related measures.

The fundamental safety and health requirements as regards the measuring and alarm function are met by compliance with

EN 50054:1993

EN 50054/A1:1996

EN 50057:1993

Test report: DMT PFG-No. 41300897

Zertifizierungsstelle Explosionsschutz  
By order:

Braunschweig, 23.02.1998

Dr.-Ing. U. Johannsmayr  
Regierungsdirektor



Seite 1/1

EC-type-examination Certificates without signature and official stamp shall not be valid. The certificates may be circulated only without alteration. Extracts or alterations are subject to approval by the Physikalisch-Technische Bundesanstalt. In case of dispute, the German text shall prevail.

Physikalisch-Technische Bundesanstalt • Bundesallee 100 • D-38116 Braunschweig



# Declaration of Conformity **EX-TEC® SR5**

New declaration of conformity. Download:  
www.sewerin.com ▶ Certificates & Approvals

## **Konformitätserklärung / Declaration of Conformity**

Gerätebezeichnung: Type of Product:	tragbares, batteriebetriebenes Gasmeßgerät portable battery-operated gas measuring device
Geräte-Typ: Product Name:	<b>SR 5 Methan, Propan</b>
Fabrikations-Nr.: Fabr.No.:	<b>041 11 xxxx, 041 12 xxxx</b>

Hiermit erklären wir, daß oben genanntes Produkt mit der / den folgenden Norm(en) oder normativen Dokument(en) übereinstimmt. Bei einer mit uns nicht abgestimmten Änderung des Produkts verliert diese Erklärung ihre Gültigkeit.

We hereby declare that the above product complies with the following norms or standardized directives. In case of any modification of this product which has not been authorized by us, this declaration becomes invalid.

Norm(en) / Norm(s):

<b>DIN EN 50 081-1</b>	EMV - Fachgrundnorm Störaussendung Generic Emission Standard
<b>DIN EN 50 082-1</b>	EMV - Fachgrundnorm Störfestigkeit Generic Immunity Standard
<b>DIN EN 50 014/18/20</b>	Ex - Allgemeine Bestimm. / Druckf. Kapselung/ Eigensicherheit General Requirements / Flameproof Encl./ Intrinsic Safety -i-
<b>DIN EN 50054/57</b>	El. Geräte für das Aufspüren brennbarer Gas El. devices to detect and measure combustible gases

Fundstellen bzgl. EN 50 081/82 sind Amtsblätter der EG Nr. C 44/12 bzw. Nr. C 90/2

The Norms EN 50 081/82 are recorded in the Gazette of the EG No. C 44/12 and no. C90/2 resp.

Gemäß den Bestimmungen der Richtlinie(n) / The unit is in accordance with:

<b>89/336/EWG</b>	EG-Richtlinie : Elektromagnetische Verträglichkeit EG-Directive: Electromagnetic Compatibility
<b>92/31/EWG</b>	Änderung dazu / amendment to above
<b>93/68/EWG</b>	Änderung dazu / amendment to above
<b>94/9/EG</b>	ATEX 100a

Gütersloh, 14.11.1997

**HERMANN SEWERIN GMBH**



( Geschäftsführer / Managing Director )

# Declaration of Conformity **EX-TEC® SR4**

New declaration of conformity. Download:  
www.sewerin.com ▶ Certificates & Approvals

## **Konformitätserklärung / Declaration of Conformity**

Gerätebezeichnung: Type of Product:	<b>tragbares, batteriebetriebenes Gasmeßgerät portable battery-operated gas measuring device</b>
Geräte-Typ: Product Name:	<b>SR 4 Methan, Propan</b>
Fabrikations-Nr.: Fabr.No.:	<b>042 11 xxxx, 042 12 xxxx</b>

*Hiernit erklären wir, daß oben genanntes Produkt mit der / den folgenden Norm(en) oder normativen Dokument(en) übereinstimmt. Bei einer mit uns nicht abgestimmten Änderung des Produkts verliert diese Erklärung ihre Gültigkeit.*

*We hereby declare that the above product complies with the following norms or standardized directives. In case of any modification of this product which has not been authorized by us, this declaration becomes invalid.*

*Norm(en) / Norm(s):*

<b>DIN EN 50 081-1</b>	<b>EMV - Fachgrundnorm Störaussendung Generic Emission Standard</b>
<b>DIN EN 50 082-1</b>	<b>EMV - Fachgrundnorm Störfestigkeit Generic Immunity Standard</b>
<b>DIN EN 50 014/18/20</b>	<b>Ex - Allgemeine Bestimm. /Druckf. Kapselung/ Eigensicherheit General Requirements /Flameproof Encl./ Intrinsic Safety -i-</b>
<b>DIN EN 50054/57</b>	<b>EI. Geräte für das Aufspüren brennbarer Gas EI. devices to detect and measure combustible gases</b>

*Fundstellen bzgl. EN 50 081/82 sind Amtsblätter der EG Nr. C 44/12 bzw. Nr.C 90/2  
The Norms EN 50 081/82 are recorded in the Gazette of the EG No. C 44/12 and no. C90/2  
resp.*

*Gemäß den Bestimmungen der Richtlinie(n) / The unit is in accordance with:*

<b>89/336/EWG</b>	<b>EG-Richtlinie : Elektromagnetische Verträglichkeit EG-Directive: Electromagnetic Compatibility</b>
<b>92/31/EWG</b>	<b>Änderung dazu /amendment to above</b>
<b>93/68/EWG</b>	<b>Änderung dazu /amendment to above</b>
<b>94/9/EG</b>	<b>ATEX 100a</b>

Gütersloh, 14.11.1997

**HERMANN SEWERIN GMBH**

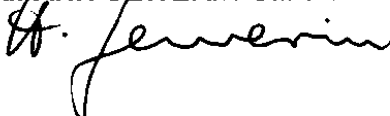

( Geschäftsführer / Managing Director )

## Declaration of Conformity **EX-TEC® SR2**

New declaration of conformity. Download:  
www.sewerin.com ▶ Certificates & Approvals

### **Konformitätserklärung / Declaration of Conformity**

Gerätebezeichnung: Type of Product:	tragbares, batteriebetriebenes Gasmeßgerät portable battery-operated gas measuring device
Geräte-Typ: Product Name:	<b>SR 2</b>
Fabrikations-Nr.: Fabr.No.:	<b>043 xx xxxx</b>

Hiermit erklären wir, daß oben genanntes Produkt mit der / den folgenden Norm(en) oder normativen Dokument(en) übereinstimmt. Bei einer mit uns nicht abgestimmten Änderung des Produkts verliert diese Erklärung ihre Gültigkeit.

We hereby declare that the above product complies with the following norms or standardized directives. In case of any modification of this product which has not been authorized by us, this declaration becomes invalid.

Norm(en) / Norm(s):

<b>DIN EN 50 081-1</b>	EMV - Fachgrundnorm Störaussendung Generic Emission Standard
<b>DIN EN 50 082-1</b>	EMV - Fachgrundnorm Störfestigkeit Generic Immunity Standard
<b>DIN EN 50 014/18/20</b>	Ex - Allgemeine Bestimm. / Druckf. Kapselung/ Eigensicherheit General Requirements / Flameproof Encl./ Intrinsic Safety -i-

Fundstellen bzgl. EN 50 081/82 sind Amtsblätter der EG Nr. C 44/12 bzw. Nr. C 90/2  
The Norms EN 50 081/82 are recorded in the Gazette of the EG No. C 44/12 and no. C90/2 resp.

Gemäß den Bestimmungen der Richtlinie(n) / The unit is in accordance with:

<b>89/336/EWG</b>	EG-Richtlinie : Elektromagnetische Verträglichkeit EG-Directive: Electromagnetic Compatibility
<b>92/31/EWG</b>	Änderung dazu / amendment to above
<b>93/68/EWG</b>	Änderung dazu / amendment to above
<b>94/9/EG</b>	ATEX 100a

Gütersloh, 14.11.1997

**HERMANN SEWERIN GMBH**

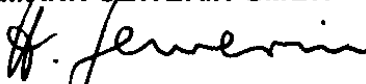

( Geschäftsführer / Managing Director )

# Declaration of Conformity VARIOTEC® 8

New declaration of conformity. Download:  
www.sewerin.com ► Certificates & Approvals

## Konformitätserklärung / Declaration of Conformity

Gerätebezeichnung: Type of Product:	tragbares, batteriebetriebenes Gasmeßgerät portable battery-operated gas measuring device
Geräte-Typ: Product Name:	Variotec 8
Fabrikations-Nr.: Fabr.No.:	040 xx xxxx

Hiermit erklären wir, daß oben genanntes Produkt mit der / den folgenden Norm(en) oder normativen Dokument(en) übereinstimmt. Bei einer mit uns nicht abgestimmten Änderung des Produkts verliert diese Erklärung ihre Gültigkeit.

We hereby declare that the above product complies with the following norms or standardized directives. In case of any modification of this product which has not been authorized by us, this declaration becomes invalid.

Norm(en) / Norm(s):

DIN EN 50 081-1	EMV - Fachgrundnorm Störaussendung Generic Emission Standard
DIN EN 50 082-1	EMV - Fachgrundnorm Störfestigkeit Generic Immunity Standard

Fundstellen bzgl. EN 50 081/82 sind Amtsblätter der EG Nr. C 44/12 bzw. Nr. C 90/2  
The Norms EN 50 081/82 are recorded in the Gazette of the EG No. C 44/12 and no. C90/2 resp.

Gemäß den Bestimmungen der Richtlinie(n) / The unit is in accordance with:

89/336/EWG	EG-Richtlinie : Elektromagnetische Verträglichkeit EG-Directive: Electromagnetic Compatibility
92/31/EWG	Änderung dazu /amendment to above
93/68/EWG	Änderung dazu /amendment to above

Gütersloh, 14.11.1997

HERMANN SEWERIN GMBH



( Geschäftsführer / Managing Director )

# Sample of Inspection Sheet (Methane-Devices)

<b>TEST REPORT</b> <b>Calibration:</b> <b>Serial Number (e.g.: 041 11 0001)</b>	<b>EX-TEC® SR5, SR4, SR2, VARIOTEC® 8</b> methane CH4 <table border="1" style="width: 100%; height: 20px; border-collapse: collapse;"> <tr> <td style="width: 25%;"></td> <td style="width: 25%;"></td> <td style="width: 25%;"></td> <td style="width: 25%;"></td> </tr> </table>					

23.10.1998

<b>1.0</b>	<b>Device status</b>									
1.1	- status correct (e.g.: Y / N)									
1.2	- fine-dust filters correct (e.g.: Y/ N)									
1.3	- remaining operating hours (e.g.: 5 h)									

<b>2.0</b>	<b>Pump test</b>									
2.1	- low pressure > 150 mbar									
2.2	- volume flow > 50 l/h									

<b>3.0</b>	<b>PPM measuring range</b>									
3.1	zero point - fresh air reading									
3.2	test gas 10 PPM CH4 - display > 5 PPM									
3.3	test gas 100 PPM CH4 - display 70 ... 140 PPM									
3.4	test gas 1.000 PPM CH4 - display 800 ... 1.200 PPM									
3.5	test gas 1,00 VOL.% CH4 - display 0,80 ... 1,20 VOL. %									

<b>4.0</b>	<b>%LEL measuring range</b>									
4.1	zero point - display -3 ... +3 %LEL or - display -0,15 ... +0,15 VOL. %									
4.2	test gas 50 %LEL = 2,20 VOL.% CH4 - display 45 ... 55 %LEL or - display 2,00 ... 2,40 VOL. %									
4.3	optical alarm (e.g.: Y/ N)									
4.4	audible alarm (e.g.: Y / N)									

<b>5.0</b>	<b>VOL.% measuring range</b>									
5.1	zero point - display -2 ... +2 VOL. %									
5.2	test gas 100 VOL.% CH4 and/or Erdgas - display 98 ... 102 VOL. %									

<b>6.0</b>	<b>Observations</b>									
	- housing broken - adjustment, repair - factory inspection - or the like									

<b>7.0</b>	<b>Test</b>									
	- day									
	- month									
	- year									
	- signature									

# Sample of Inspection Sheet (Propane-Devices)

<b>TEST REPORT</b> Calibration: Serial Number (e.g.: 041 12 0001)	<b>EX-TEC® SR5, SR4, SR2, VARIOTEC® 8</b> propane C3H8 <input style="width: 60px; height: 15px;" type="text"/>	
---	--	---

23.10.1998

<b>1.0</b>	<b>Device status</b>								
1.1	- status correct (e.g.: Y / N)								
1.2	- fine-dust filters correct (e.g.: Y/ N)								
1.3	- remaining operating hours (e.g.: 5 h)								

<b>2.0</b>	<b>Pump test</b>								
2.1	- low pressure > 150 mbar								
2.2	- volume flow > 50 l/h								

<b>3.0</b>	<b>PPM measuring range</b>								
3.1	zero point - fresh air reading								
3.2	test gas 10 PPM CH4 - display > 5 PPM								
3.3	test gas 100 PPM CH4 - display 70 ... 140 PPM								
3.4	test gas 1.000 PPM CH4 - display 800 ... 1.200 PPM								
3.5	test gas 1,00 VOL.% CH4 - display 0,80 ... 1,20 VOL.%								

<b>4.0</b>	<b>Meßbereich %LEL</b>								
4.1	zero point - display -3 ... +3 %LEL or - display -0,06 ... +0,06 VOL.%								
4.2	test gas 59 %UEG = 1,00 VOL.% C3H8 - display 55 ... 64 %LEL or - display 0,90 ... 1,10 VOL.%								
4.3	optical alarm (e.g.: Y/ N)								
4.4	audible alarm (e.g.: Y / N)								

<b>5.0</b>	<b>VOL.% measuring range</b>								
5.1	zero point - display -2 ... +2 VOL.%								
5.2	test gas 100 VOL.% C3H8 - display 98 ... 102 VOL.%								

<b>6.0</b>	<b>Observations</b>								
	- housing broken - adjustment, repair - factory inspection - or the like								

<b>7.0</b>	<b>Test</b>								
	- day								
	- month								
	- year								
	- signature								

*Hermann Sewerin GmbH  
Robert-Bosch-Straße 3 · D-33334 Gütersloh  
Telefon +49 - (0) - 52 41/9 34-0 · Telefax +49 - (0) - 52 41/9 34-4 44  
<http://www.sewerin.com>*