

PORTAFID® m3 / m3K

Operating Instructions



SEWERIN
Technologies for leak detection.

Measurable success by Sewerin equipment

Congratulations. You have chosen a quality instrument manufactured by Hermann Sewerin GmbH.

Our equipment will provide you with the highest standards of performance, safety and efficiency. They correspond with the national and international guide-lines.

Please read and understand the following operating instructions before using the equipment; they will help you to use the instrument quickly and competently. If you have any queries we are available to offer advice and assistance at any time.

Yours

Hermann Sewerin GmbH

Robert-Bosch-Straße 3
33334 Gütersloh, Germany
Tel.: +49 5241 934-0
Fax: +49 5241 934-444
www.sewerin.com
info@sewerin.com

SEWERIN SARL

17, rue Ampère - BP 211
67727 Hoerdts Cedex, France
Tél. : +33 3 88 68 15 15
Fax : +33 3 88 68 11 77
www.sewerin.fr
sewerin@sewerin.fr

SEWERIN IBERIA S.L.

Centro de Negocios Eisenhower
Avenida Sur del Aeropuerto
de Barajas 28, Planta 2
28042 Madrid, España
Tel.: +34 91 74807-57
Fax: +34 91 74807-58
www.sewerin.com
info@sewerin.es

Sewerin Portugal, Lda

Rua Sr. Dos Milagres, 16, 2º Esq
3800-261 Aveiro, Portugal
Tlf.: +351 234 133 740
Fax.: +351 234 024 446
www.sewerin.com
info@sewerin.pt

Sewerin Sp.z o.o.

ul. Twórcza 79L/1
03-289 Warszawa, Polska
Tel.: +48 22 675 09 69
Tel. kom.: +48 501 879 444
www.sewerin.pl
info@sewerin.pl

Sewerin Ltd

Hertfordshire
UK
Phone: +44 1462-634363
www.sewerin.co.uk
info@sewerin.co.uk

Left and right side of the Portafid M3

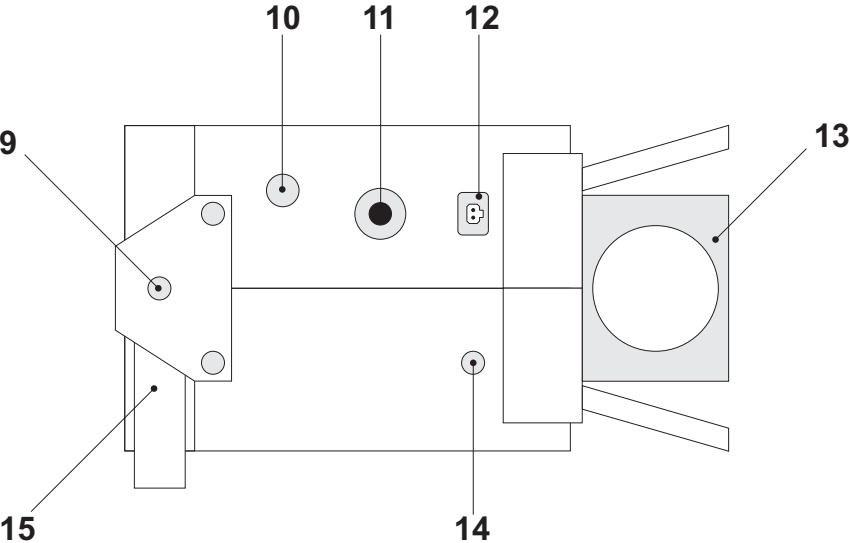
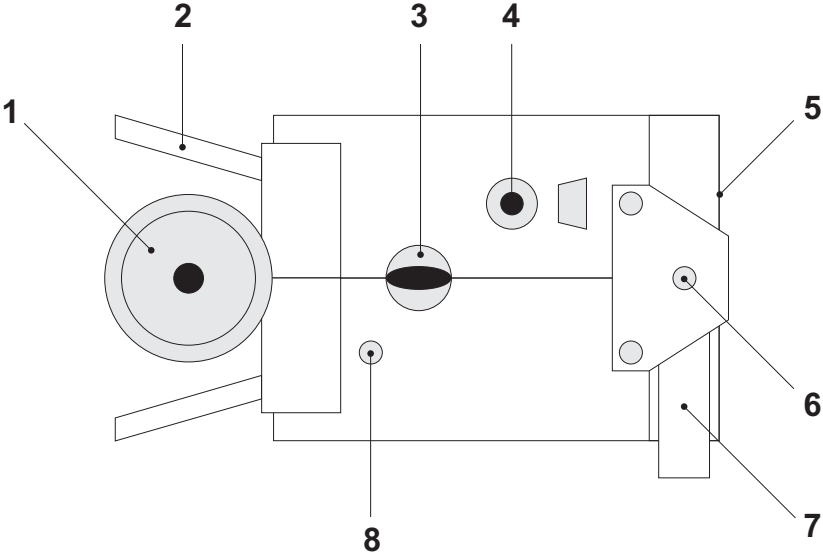

Left and right side of the Portafid M3K

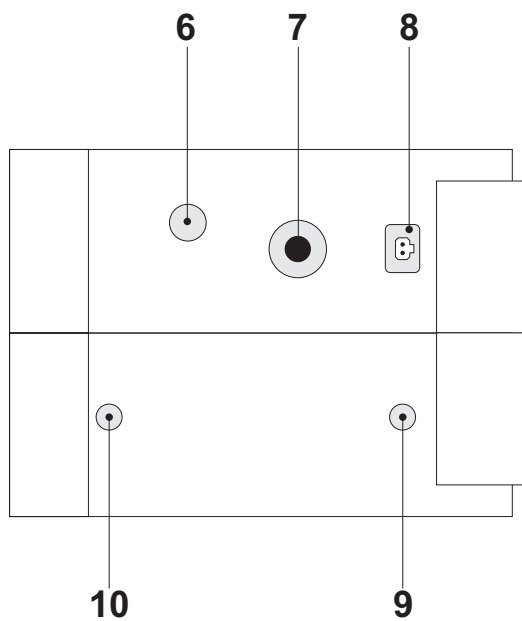
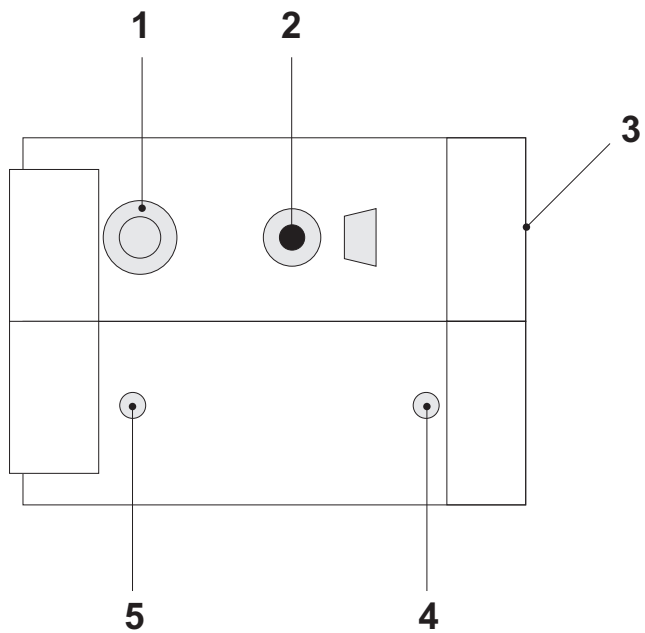

Operating Instructions

PORTAFID[®] M3

PORTAFID[®] M3K

12.08.2020 – V1.XXX – 102708 – en

For your safety

This product may only be operated by appropriately-trained persons who are familiar with the relevant operating manual.

It may only be used for its designated purpose, i.e. for industrial and commercial use.

Repair work may only be carried out by specialists or by persons who have undergone appropriate training.

Any alterations or modifications to the product require the prior approval of Hermann Sewerin GmbH. In the event of unauthorised alterations to the product the manufacturer accepts no liability for damage.

Only Hermann Sewerin GmbH accessories may be used with the product.

Only spare parts approved by us may be used for repairs.

Hermann Sewerin GmbH accepts no liability for damage resulting from non-compliance with the foregoing. The guarantee and liability provisions in the Hermann Sewerin GmbH terms of sale and supply are not extended by the foregoing.

We reserve the right to make changes in the context of continued technical development.

In addition to these instructions, please comply with generally applicable safety and accident-prevention regulations!

Symbols used:



CAUTION!

This symbol is used to indicate dangers which may either result in hazards for the operators or in severe damage – or even destruction – of the product.



Note:

This symbol is used to call attention to information and tips which may be helpful and which are exceeding the basic operating procedures.

1	PORTAFID M3/M3K models	1
1.1	Probe systems	2
2	Measuring operation	3
2.1	Switching on	5
2.2	Illumination and contrast	7
2.3	Alarm signal and volume	7
2.4	Alarm-threshold value	8
2.5	Switching measuring ranges	8
2.6	Zero point adjustment	9
2.7	Battery alarm	10
2.8	Switching off	10
2.9	Pressure reading	10
3	Charging equipment	12
4	Inspection, testing and maintenance	14
4.1	Testing technique	15
5	Adjustment	16
6	Technical notes	22
7	Technical data	24
8	Accessories	25
9	Error messages	26
10	Wearing parts	27
11	Appendix	28
11.1	EU declaration of conformity	28
11.2	Inspection protocol	29

1 PORTAFID M3/M3K models

Both gas detectors are suitable for the following purposes:

- testing underground supply-line piping
- crossing landfill sites

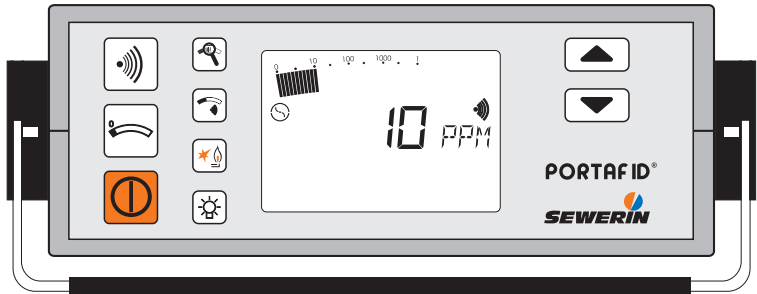

PORTAFID M3 compact device with 0.1 l steel bottle beneath it, for short-term use

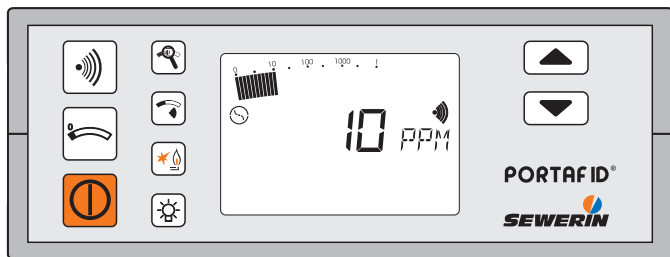

PORTAFID M3K column device with separate 0.47 l steel bottle and comfortable harness, for an 8-hour day

1.1 Probe systems

Pipes monitoring probes



Carpet probe FID

Part no.: ZS01-11200

- for checking stable surfaces. The sample is drawn into an excrescence in a neoprene mat in contact with the surface with no extraneous emissions.



Bell probe FID

Part no.: ZS05-10100

- for checking unstable and overgrown surfaces. It can be used in confined spaces, e.g. between parked cars or in front gardens.



Note:

Except with the carpet probe, a probe hose should always be used **with** a hydrophobic filter

2 Measuring operation



Note:

Please fold out the **PORTAFID M3** illustration inside the front cover.

Item	Description	Function
1	Handwheel	opens and closes the fuelgas bottle
2	Stand	holds the device in the correct position
3	Cylinder release	disconnects the fuelgas bottle
4	Buzzer	acoustic warning signal
5	LCD	displays gas concentrations and operating status
6, 8	Attachment points	for carrying straps
7, 15	Carrying handle	transporting the device
9, 14	Attachment points	for carrying straps
10	Discharge	of gas sample
11	Probe connector	connects to the probes described
12	Charger socket	connects to chargers
13	Mounting	for fuelgas bottle

**Note:**

Please fold out the **PORTAFID M3K** illustration inside the front cover.

Item	Description	Function
1	Fuelgas connection	connects to the fuelgas cylinder on the harness
2	Buzzer	acoustic warning signal
3	LCD	displays gas concentrations and operating status
4, 5	Attachment points	for harness
6	Discharge	der Gasprobe
7	Probe connector	connects to the probes described
8	Charging socket	connects to chargers
9, 10	Attachment points	for harness

2.1 Switching on

**Note:**

When in use the gas detector must always be in the correct position, i.e. with the LCD uppermost .

Do not disconnect the PORTAFID M3 fuelgas bottle unless the pressure is less than < 20 bar.

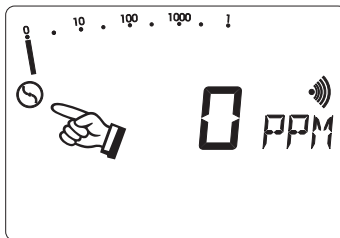
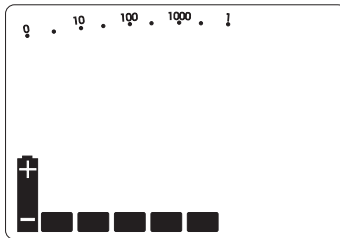

- **PORTAFID M3**

open the 0.1 l fuelgas bottle (item 1) by turning to the right

- **PORTAFID M3K**

open the 0.47 l fuelgas bottle on the harness by turning to the right

- press the **ON/OFF key** for about 2 seconds
- the buzzer (item 4) sounds for about 2 seconds
- remaining operating hours are displayed in the form of a bar graph (e.g. 5 hours)
- the built-in pump runs at maximum power
- the appropriate symbol appears in the LCD (item 5) to enable the pump function to be monitored

2 Measuring operation

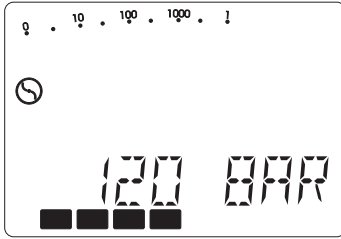

- only the **PORTAFID M3** displays:
fuelgas inlet pressure (e.g. 120 BAR) and
fuelgas operating time in the form of a bar graph (e.g. 4 hours)

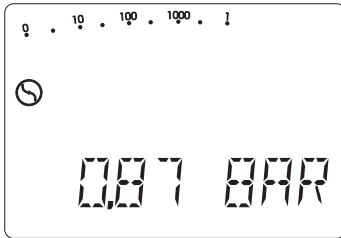

- display of:
fuelgas outlet pressure (e.g. 0,87 BAR)
- the interval alarm sounds



Note:

This display appears only if:

- the fuelgas outlet pressure is outside the set range of 0.95 – 1.10 bar (for how to correct this see “6.0 Technical notes”)
- the fuelgas bottle is empty (i.e. the cylinder pressure is less than < 10 bar) and needs refilling or replacing.

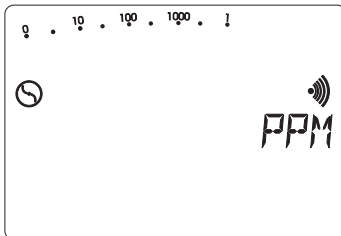

- automatic ignition now takes place

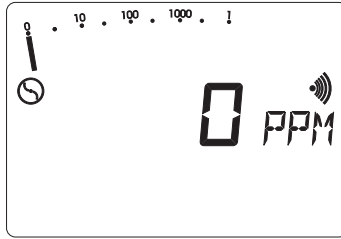

- after ignition wait until the zero point in fresh air has established itself (about 2 – 3 minutes):

0 PPM

(after flashing stops)

2.2 Illumination and contrast



- Repeatedly pressing the **Light key** switches the LCD illumination on and off

- after about 4 minutes the illumination automatically switches off

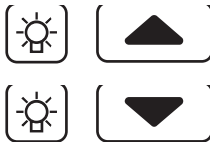

- simultaneously pressing the **Light key** and one of the **Arrow keys** increases or reduces the contrast of the LCD

2.3 Alarm signal and volume



- Repeatedly pressing the **Signal key** switches the alarm signal on and off

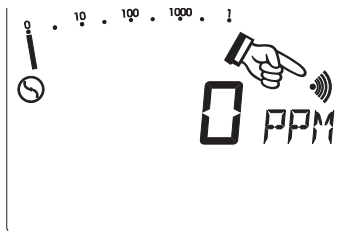

- the appropriate symbol appears in or disappears from the LCD (item 5)

- this enables you to monitor the alarm signal

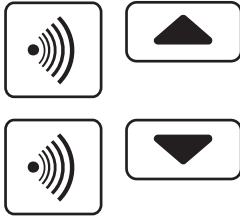

- simultaneously pressing the **Signal key** and one of the **Arrow keys** increases or reduces the buzzer volume (item 7)

2.4 Alarm-threshold value

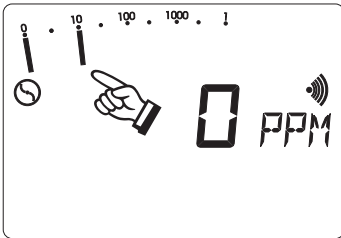

- As long as the **Threshold value key** is held down
- the alarm-threshold value (e.g. 10 PPM) flashes in the full-range analogue display

- repeatedly pressing one of the **Arrow keys** while holding down the **Threshold value key** increases or reduces the alarm-threshold value
- this value is preserved even when the detector is switched off

2.5 Switching measuring ranges

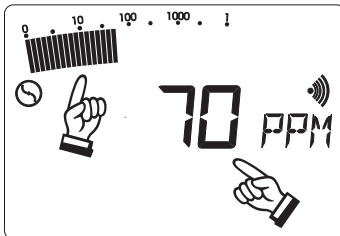

- All detectors have an **analogue display** (above, full range) and a **digital display** (below); both scales indicate the same concentration (e.g. 70 PPM)
- the analogue display is a logarithmic scale covering the range: 0 PPM – 1 %VOL

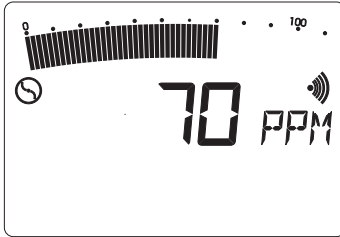

- here the display of low concentrations is intensified; the measurement result can be read off from the digital display
- repeatedly pressing the **Zoom key** switches between the full and **optimum ranges**
- depending on the concentration, switching between the following measurement ranges is **automatic**:
 0 – 10 PPM 0 – 1000 PPM
 0 – 100 PPM 0 – 1 %VOL
- the optimum measurement range in this example is 0 – 100 PPM
- repeatedly pressing one of the **Arrow keys** while holding down the **Zoom key** switches manually to the required display range

2.6 Zero point adjustment



- If the detector fails to reach its zero point of **0 PPM** after flushing with copious fresh air, pressing the **Zero point key** enables you to adjust it manually
- the reading display flashes while the adjustment is being carried out
- measurement cannot be resumed until **after** the flashing stops

2.7 Battery alarm

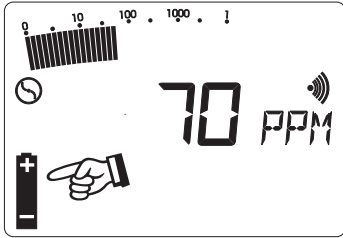

- If the battery symbol appears in the LCD, at least 15 minutes' operating time remains; after that the detector must be recharged

2.8 Switching off

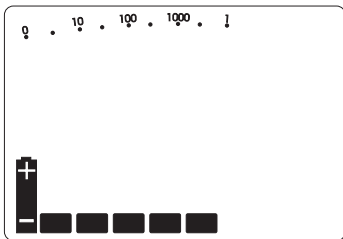

- Press the **ON/OFF key** for about 2 seconds
- the buzzer (item 4) sounds for about 2 seconds
- remaining operating hours are displayed in the form of a bar graph (e.g. 5 hours)

2.9 Pressure reading



- You can display the current cylinder pressure even when the **PORTAFID M3** is switched off
- open the 0.1 l fuelgas bottle (item 1) by turning to the right
- press the Ignition key

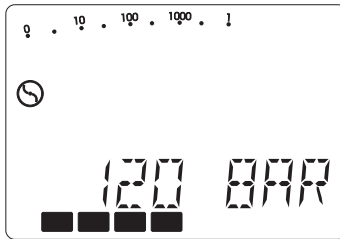

- this displays the:
fuel-gas inlet pressure
(e.g. 120 BAR) and
fuel-gas operating time in
the form of a bar graph (e.g.
4 hours)
- the detector automatically
switches off; close the bottle
again

3 Charging equipment

When fully charged the **PORTAFID M3** and **M3K** can be operated for a **maximum** of 8 hours with the pump running.

The gas detectors can be charged in the workshop or in the emergency vehicle.

The following connection devices are available:



AC/DC adapter M4 100 – 240 V~

Part no.: LD10-10001



Car cable M4 12 V= mounting

Part no.: ZL07-10000

- with built-in fuse and blade receptacles, for the fix connection to vehicle electrics



Car cable M4 12 V= mobile

Part no.: ZL07-10100

- with built-in fuse and connector for cigarette lighter, for mobile vehicle mounting



Car cable M4 24 V= mounting

Part no.: ZL09-10000

- with voltage transformer and blade receptacles, for the fix connection to vehicle electrics

Charging

Connect the detector (switched off) to a charger and a display of the following type appears:

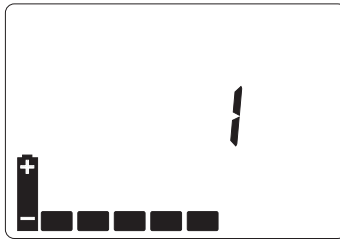

- the detector still has 5 operating hours left (= 5 bars) and will take one more hour to be fully recharged
- the instrument is quickly chargeable and the maximum charging time is approx. 2.5 hours
- when it is fully charged all the bars are visible and the number display disappears
- the detector can be left connected to the charger until the next time it is needed



Note:

Due to the fast-charging option, the admissible temperature range is 0 °C – +40 °C during charging.

Spontaneous discharge

If the detector is not connected to the charger when switched off, the nickel-metal-hydride accu spontaneously discharges, thus reducing the available operating hours.

After a maximum of 30 days the detector indicator shows that there are no operating hours left, and it must be recharged.

4 Inspection, testing and maintenance

DVGW work sheet G 465-4 requires detectors to be inspected, tested and maintained.

Sensitivity testing

may be necessary several times a day, according to G 465-1, depending on the circumstances - particularly with gas detectors used to monitor mains pipes.

Inspection

must be carried out up to six times a year, depending on frequency of use - and at any rate at least once a year. The following items must be tested:

- detector condition
- pump power
- battery condition
- zero point
- intake channel
- sensitivity (with test gas)

Test report

Test results must be recorded. A specimen form will be found on the last page of this manual.

Servicing and maintenance

DVGW work sheet G 465-4 specifies that servicing and maintenance of the detectors may be carried out only by the following persons:

- the SEWERIN Service or
- an expert authorised by SEWERIN.

Servicing must be carried out at least once a year. The next scheduled date must be entered on the inspection sticker attached to the detector (month/year).

After servicing a certificate must be completed.

4.1 Testing technique

The test case PPM complete is used to check and calibrate the sensitivity and pump capacity within the ppm range.

Testing can be effected with carpet or bell probes.



Test case PPM complete

Part no.: ZP03-12001

- test set SPE ppm incl. flowmeter (0 – 80l/h)
- hard-shelled case, orange coloured, with foam inlet
- 0.4 l test gas bottle, 10 ppm CH₄ (methane) in synthetic air, pressure 100 – 150 bar
- pressure regulator and manometer
- test plate for probe testing and connection hoses

5 Adjustment

The **PORTAFID M3** and **PORTAFID M3K** detectors are factory-set to the 10 ppm measuring range.

You can adjust each of the ranges using appropriate test gases (one for each range).

Testing procedure

Connect your detector to the test set.



- now press this combination of buttons simultaneously

First Display - version number/zero point

Once the number of available operating hours has been displayed the detector is in **adjustment mode**:

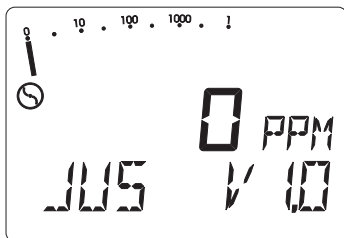

- the software version number (e.g. V1.0) is displayed and the pump runs at maximum power
- the reading display flashes until the zero point of the FID system has been automatically established
- once the zero point has been set, press the **Arrow-up key** to move to the next display

10 ppm adjustment

Now release the 10 ppm methane CH₄ test gas from the SPE ppm test set.

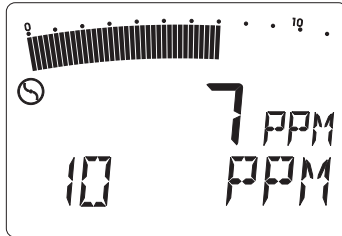

- wait until the display has stabilised



- confirm the adjustment with the **ON/OFF key** (OK appears in the LCD)



- turn off the test-gas feed
- press the **Arrow-up key** to move to the next display

100 ppm adjustment

Now release the 100 ppm methane CH₄ test gas from the SPE ppm test set.

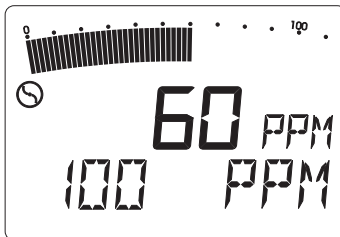

- wait until the display has stabilised



- confirm the adjustment with the **ON/OFF key** (OK appears in the LCD)



- turn off the test-gas feed
- press the **Arrow-up key** to move to the next display

1000 ppm adjustment

Now release the 1000 ppm methane CH₄ test gas from the SPE ppm test set.

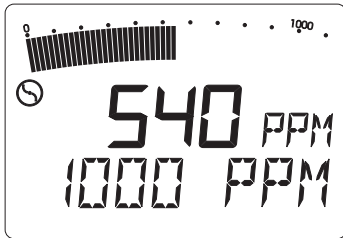

- wait until the display has stabilised



- confirm the adjustment with the **ON/OFF key** (OK appears in the LCD)



- turn off the test-gas feed
- press the **Arrow-up key** to move to the next display

1.00 vol.% adjustment

Now release the 1.00 vol.% methane CH₄ test gas from the SPE ppm test set.

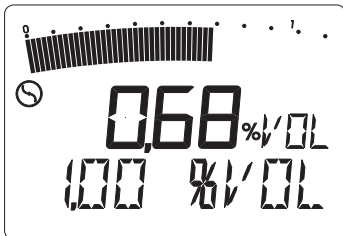

- wait until the display has stabilised



- confirm the adjustment with the **ON/OFF key** (OK appears in the LCD)



- turn off the test-gas feed
- press the **Arrow-up key** to move to the next display

Vol.% range language

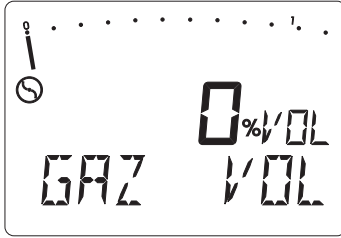

- By repeatedly pressing the **ON/OFF key** you can choose between the following displays in the vol.% range:

%VOL – concentration display in vol.%
(German/English)

%GAZ – concentration display in vol.%
(French)

- confirm the display, e.g. %VOL, with the **ON/OFF key** (**OK** appears in the LCD)
- this setting is retained even when the detector is switched off
- press the **Arrow-up key** to move to the next display

10 PPM sensitivity

Whether synthetic or fresh air is used for the zero-point adjustment, you must always achieve sensitivity of > 5 ppm when using 10 ppm methane CH₄ test gas.

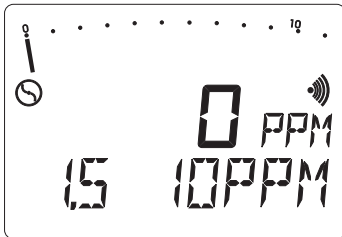

- To this end you can select from the following amplification ratios in the 10 ppm range by repeatedly pressing the **ON/OFF key** switch:

1,0 x 10 PPM – 100 % amplification

1,2 x 10 PPM – 120 % amplification

1,5 x 10 PPM – 150 % amplification
(factory setting)

- confirm the selected amplification (e.g. **1.5 x 10 PPM**) with the **ON/OFF key**
- press the **Arrow-up key** to move to the next display

LCD check

With this function you can check whether all elements of the LCD are operating normally.

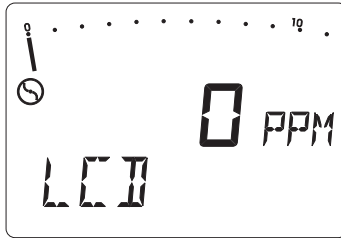

- confirm the LCD check with the **ON/OFF key**



- press the **Arrow-up key** to return to the first display

Leave adjustment mode (possible only in the first display)



- simultaneously press both **Arrow keys** to return to normal measuring operation



or



- press the **ON/OFF key** to switch the detector off

6 Technical notes

Delayed-action indicator

To facilitate the comparison of different gas concentrations, the maximum value is displayed by a flashing delayed-action indicator.

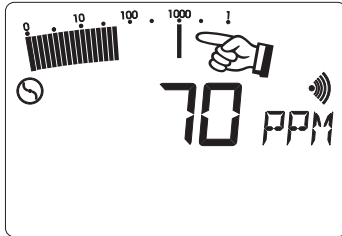

- this remains in the LCD (item 5) for about 4 minutes unless updated by a higher concentration

Fine dust filters

There are fine dust filters in the screw-on probe connector (item 3) and in most probes.

The filters can be cleaned by tapping or blowing to remove the dust.



Note:

After cleaning the filters must be replaced in the same position as before.

Heavily-soiled filters should be replaced by new ones (accessories).

Adjusting the outlet pressure

PORTAFID M3: the outlet pressure is adjusted on the underside of the detector with an Allen key (supplied).

PORTAFID M3K: the outlet pressure is adjusted at the pressure gauge on the harness.

Automatic alarm reset

If the alarm threshold is exceeded the acoustic alarm is set off.



- It can be switched off with the **Signal key**.

After about 2 minutes it is automatically reset.

Cleaning

No solvents, benzines or similar substances may be used to clean the detectors.

Oxygen concentration

The detectors are electrically safe to use in an oxygen concentration of up to 21 vol.%.

At oxygen concentrations of < 16.0 vol.%, the H₂ flame might cease (F 110).

7 Technical data

Detector types	PORTAFID M3 PORTAFID M3K
Calibration	Methane (CH ₄)
Measuring range	0 – 10,000 ppm = 1 vol.%
Measurement range definition	10 ppm – 1 ppm steps 100 ppm – 2 ppm steps 1000 ppm – 20 ppm steps 1 vol.% – 0.02 vol.% steps
Measuring error	≤ 1 %
Measurement system	Flame-Ionisation-Detector
Pump power	> 50 l/h and >150 mbar
Alarm threshold	3 ppm (variable)
Operating time	Electrical: 8 hours Fuel gas: 5 hours (0.1 l) 25 hours (0.47 l) (at 150 bar cylinder pressure)
Power supply	NiMh-battery, rechargeable
Dimensions (W x H x D) and weight	PORTAFID M3 270 × 185 × 105 mm/3.800 g PORTAFID M3K (without bottle) 270 × 140 × 105 mm/1.700 g
Operating temperature	-10 °C to +40 °C
Storage temperature	-25 °C to +70 °C
Humidity range	5 % r.h to 90 % r.h. (non-condensing)
Pressure range	900 h Pa to 1100 h Pa
Charging time	2.5 hours
Charging temperature	0 °C to +40 °C

8 Accessories

Charging technique	AC/DC adapter M4 100 – 240 V~/12 V=, Car cable M4 12 V or 24 V
Probe systems	carpet probe and bell probe for Network Survey
Probe hose	with hydrophobic filter and quick connect
Plunger bar	for making probe holes manually handle insulated to 10 kV working lengths 625 mm, 1025 mm and 1325 mm
Testing technique	Test case PPM complete Test set SPE ppm
System case	with foam lining and compartments for accessories
Carrying systems	PORTAFID M3: cross-straps, PORTAFID M3K: harness

9 Error messages

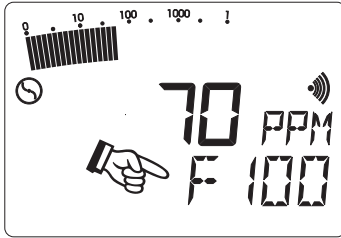

- The detectors automatically identify errors and show the error code in the LCD (item 5)

Error code	Cause and remedy
F10 – F14	Adjustment errors in the PPM range, check testgas or repeat adjustment
F50 – F56	Component errors, remedy: contact Sewerin service
F100	pump power inadequate, e.g. because ambient temperatures are too low switch detector off and on again, check filters in detector and probes
F110.....	flame extinguished excessive gas concentration in the combustion chamber flush out and manually reignite
F200	AC/DC adapter defect
F201	Temperature during charge out of admissible range



Note:

If any other error codes are displayed, please contact the SEWERIN Service.

10 Wearing parts

Fine dust filter	in the detectors' probe connectors (item 11 or 7)
Hose filter	in the carpet probe and probe hose
Probe filter inlet	in the bell probe
Hydrophobic filter	in the 1 m, 2 m and 6 m probe hoses
Neoprene mat	for the carpet probe

11 Appendix

11.1 EU declaration of conformity

Hermann Sewerin GmbH hereby declares that the **PORTAFID® M3/PORTAFID® M3K** Hermann Sewerin GmbH hereby declares that the systems fulfil the requirements of the following guidelines:

- 2014/30/EU

Gütersloh, 2016-04-20



Dr. S. Sewerin (General Manager)

The complete declaration of conformity can be found online.

11.2 Inspection protocol

Inspection protocol Calibration: Serial Number : (e.g.: 003 01 0001)	PORTAFID[®] M3 / M3K Methane CH ₄ <div style="border: 1px solid black; width: 100px; height: 15px; margin-top: 5px;"></div>	
01.08.2020		
1.0 Device status		
1.1	- Status correct (e.g.: Y / N)	
1.2	- Remaining operating hours (e.g.: 5 h)	
2.0 Pump check		
2.1	- Pump error F100 in seal	
3.0 PPM measuring range		
3.1	Zero point - Fresh air reading	
3.2	Test gas 10 ppm CH ₄ - Display ≥ 8 ppm in 10 seconds	
3.3	Test gas 100 ppm CH ₄ - Display 90 – 110 ppm	
3.4	Test gas 1.000 ppm CH ₄ - Display 900 – 1.100 ppm	
3.5	Test gas 1.00 vol.% CH ₄ - Display 0.90 – 1.10 vol.%	
4.0 Alarm function		
4.1	- Audible alarm signal (e.g.: Y / N)	
5.0 Observations		
	- Housing broken	
	- Repair	
	- Adjustment	
	- Factory inspection	
	- or the like	
6.0 Test		
	- Day	
	- Month	
	- Year	
	- Signature	

Hermann Sewerin GmbH
Robert-Bosch-Straße 3 · 33334 Gütersloh · Germany
Telefon +49 5241 934-0 · Telefax +49 5241 934-444
www.sewerin.com · info@sewerin.com