

EX-TEC® PM 580/550/500/400



Device



Fig. 1: Front view



Fig. 2: Rear view (left image) and underside of the device with battery pack (right image)

Display

Application



Measurement value 1:

- Bar graph with quasi-logarithmic scale
- Measurement value, gas, unit

Measurement value 2:

- Measurement value, gas, unit

Remaining capacity (disposable/rechargeable battery)

Fig. 3: Display in measuring mode - Structure **application**

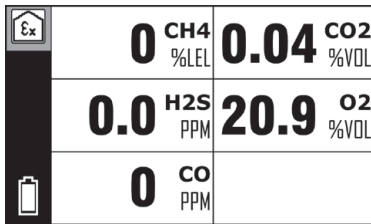

Fig. 4: Display in measuring mode
 Left image: **Warning** application
 Right image: **Measuring** application

Illustration of warnings in this document



DANGER!

Risk of personal injury. Will result in serious injury or death.



WARNING!

Risk of personal injury. Can result in serious injury or death.



CAUTION!

Risk of personal injury. Can result in injury or a risk to health.

NOTICE!

Risk of damage to property.

1	Introduction	1
1.1	Information about this document.....	1
1.2	Purpose	2
1.3	Intended use	2
1.4	Improper use	2
1.5	Safety information	3
1.6	Qualification of users.....	5
2	Product description	6
2.1	Product variants	6
2.2	Application options	7
2.2.1	Detectable gases	7
2.2.2	Applications.....	8
2.3	Features	9
2.3.1	Sensors	9
2.3.2	Gas types	11
2.3.3	Visual and audible signals.....	11
2.3.3.1	Overview	11
2.3.3.2	Signal for paused measurement	12
2.3.3.3	Operating signal.....	13
2.3.3.4	Alarm signals.....	13
2.3.3.5	Signals in the event of faults	14
2.3.4	Display illumination	14
2.3.5	Gas input and filter	14
2.3.6	Belt clip and short probe	15
2.4	Additional probes	16
2.5	Measuring mode and menu	16
2.6	Units for concentration data	18
2.6.1	Selectable units (warning).....	18
2.6.2	Conversion of the concentration data	18
3	Operation	19
3.1	Switching on the device	19
3.2	Switch off device	22
3.3	Navigating	23
3.3.1	Orientation aids on the display.....	23
3.3.2	Key functions.....	25
3.3.3	Switch between levels.....	26
3.3.3.1	Changing from measuring mode to menu or measuring menu	26

3.3.3.2	Switch from menu or the measuring menu into measuring mode	27
3.3.3.3	Select a menu item in a menu.....	27
3.3.4	Cancel the action or process.....	27
3.3.5	Scrolling	27
3.3.6	Select values.....	28
3.3.7	Answer questions.....	29
3.3.8	Lists - view detailed information	29
3.3.9	Write comment.....	30
3.4	Start, stop, save recording	31
3.4.1	Start recording.....	32
3.4.2	Stop recording and save without a comment.....	32
3.4.3	Stop recording and save it with a comment	33
3.5	Change application	34
3.6	Set zero point.....	35
3.7	Changing gas type	37
3.8	Changing the settings on the device	38
3.9	Concentration-dependent signal (structure).....	39
3.10	Leak test when using probes	40
3.11	Changing the filter	41
4	Settings	44
4.1	General information about the settings	44
4.2	Settings using the GasCom software.....	44
4.3	Settings on the device.....	45
4.3.1	Access to the settings using PIN code.....	45
4.3.2	Adjustment	45
4.3.3	Restore.....	46
4.3.4	Date/time.....	46
4.3.5	PPM threshold.....	47
5	Protocols and information	48
5.1	Protocols	48
5.2	Information	50
6	Maintenance	53
6.1	Scope of maintenance (overview).....	53
6.2	Test gases	53
6.2.1	Utilisable test gases	53
6.2.2	Available test gases	54

6.2.3	Gas mixtures for adjusting devices with a COSH sensor.....	55
6.3	Suitable environment	55
6.4	Device inspection	55
6.4.1	Ways of carrying out the procedure	56
6.4.2	Frequency and due date	57
6.4.3	Variants of the guided device inspection (standard and ECO)	59
6.4.4	Features	59
6.4.5	Presentation of results	60
6.4.6	Required accessories.....	61
6.4.7	Perform a device inspection	61
6.4.7.1	Requirements (summary).....	61
6.4.7.2	Start device inspection	62
6.4.7.3	Checking the device condition	62
6.4.7.4	Testing the pump.....	63
6.4.7.5	Testing the zero point.....	63
6.4.7.6	Testing the indication accuracy (standard device inspection).....	63
6.4.7.7	Performing a bump test (ECO device inspection).....	64
6.4.7.8	Saving the device inspection.....	65
6.4.8	Measuring response time	65
6.5	Adjustment	65
6.5.1	Frequency	66
6.5.2	Features	66
6.5.3	Presentation of results	67
6.5.4	Required accessories.....	67
6.5.5	Performing an adjustment	68
6.5.5.1	Requirements (summary).....	68
6.5.5.2	Warning application.....	69
6.5.5.3	Measuring application	70
6.5.5.4	Structure application	71
6.6	Servicing	72
7	Power supply	73
7.1	Overview	73
7.2	Approved disposable batteries and rechargeable batteries	74
7.3	Rechargeable batteries	76
7.3.1	Charging mode.....	76
7.3.1.1	Required accessories.....	77
7.3.1.2	Charging the batteries.....	77
7.3.2	Rechargeable battery servicing.....	78
7.4	Alarm at undervoltage	78

7.5	Changing the disposable/rechargeable batteries	79
8	Faults and problems	80
8.1	Error messages	80
8.2	Warning messages	81
8.3	Resolution of problems	81
8.3.1	Device has sucked water in	81
8.3.2	Temporary zero point cannot be set	83
9	Appendix	84
9.1	Technical data	84
9.2	Sensors	87
9.2.1	Infrared sensors	87
9.2.2	Semiconductor sensor	91
9.2.3	Catalytic combustion sensor	92
9.2.4	Electrochemical sensors	94
9.2.5	Measuring ranges in the applications (overview)	98
9.3	Test gases	100
9.3.1	Preset test gases	100
9.3.2	Setting ranges:	101
9.4	Alarms	103
9.4.1	Features	103
9.4.2	Setting ranges:	106
9.4.3	Alarm thresholds (condition at delivery)	107
9.5	LEL	107
9.6	Limit values for device inspection	108
9.7	Type examinations	108
9.7.1	Explosion protection test	108
9.7.2	Functional safety test	109
9.8	Device identification	110
9.9	Symbols on the display	111
9.10	Accessories and consumables	116
9.11	Care	118
9.12	Advice on disposal	118
9.13	Legal basis	119
9.14	Declaration of conformity	120
9.15	Abbreviations	120
9.16	Technical terms	121
10	Index	123

1 Introduction

1.1 Information about this document

This document is a component part of the product.

- Read the document before putting the product into operation.
- Keep the document within easy reach.
- Pass this document on to any subsequent owners.
- Unless otherwise specified, the information in this document refers to the product as delivered (factory settings) and applies to all product variants.
- The product is described with all device features. Not all of the functions described may be available on the product you are using. Please contact the SEWERIN sales department for further information.
- Contradictory national legal regulations take precedence over the information in this document.

Translations

Translations are produced to the best of our knowledge. The original German version is authoritative.

Right of reproduction

No part of this document may be edited, duplicated or circulated in any form without the express consent of Hermann Sewerin GmbH.

Registered trademarks

Registered trademarks are generally not indicated in this document.

1.2 Purpose

The device is a portable, ex-proof gas concentration measuring device for detection, measuring and warning.

The device can be used for:

- Pinpointing leaks in gas pipes that are not underground
- Assessment of the risk of explosion in work areas
- Identification of gas components

The device is suitable for the following applications (/3/):

- Warning
- Measuring
- Structure

1.3 Intended use

The product is suitable for the following uses:

- professional
- industrial
- commercial

The product must only be used for the applications specified in section 1.2.

The gases that can be measured with the product depend on the product variant and the selected device features. For more detailed information please see section 2.

The product can be used at operating temperatures up to 40°C. However, high temperatures can reduce the lifetime of the sensors, disposable batteries and rechargeable batteries.

1.4 Improper use

The product must not be used for:

- Pinpointing leaks in underground gas pipes
- Gas analysis of technical processes
- Monitoring liquids

1.5 Safety information

This product was manufactured in keeping with all binding legal and safety regulations.

The product is safe to operate when used in accordance with the instructions provided. However, when handling the product, there may be risks to persons and property. For this reason, observe the following safety information without fail.

- Observe all the applicable safety standards and accident prevention regulations.
- Use the product only as intended.
- Do not make any changes or modifications to the product unless these have been expressly approved by Hermann Sewerin GmbH.
- Only use accessories and consumables approved by Hermann Sewerin GmbH.
- Always observe the permitted operating and storage temperatures.
- Handle the product carefully and safely, both during transport and when working.
- Do not use the product if it is damaged or faulty.
- When the device has suffered an impact (such as being accidentally dropped):
 - Then perform a device inspection. ¹
- Protect the ports and sockets against dirt, and electrical ports in particular against moisture.

Explosion protection

The device is suitable for use in explosive environments. Please note the following exceptions:

- Do not operate the device in oxygen-enriched atmospheres, otherwise the device will not be explosion-proof.
- The device must not be stored or operated in explosive environments if there is a chance of strong electrostatic charges occurring (e.g. from fast moving particles, hydraulically pro-

¹ For the PM 400 SEWERIN also recommends: If the LEL sensitivity deviates by more than 20%, replace the CC sensor.

pelled liquids, pneumatically extracted dust or materials, in electrostatic coating processes).

Certain activities with the device must be performed outside of an explosive environment. The corresponding warnings can be found in these operating instructions in the descriptions of actions.

Maintenance

- Perform device inspection and adjustment only in well ventilated rooms or outdoors.
- Handle test gases in a professional manner.

Sensors

- Have sensors replaced by SEWERIN Service when their service life has expired.
- SEWERIN recommends: Perform a device inspection when the device has been exposed to gas concentrations above the end of measuring range.

Special environments

- Substances containing silicone, and silicone vapours, can contaminate the sensors.
 - Do not allow the device to come into contact with substances containing silicone.
 - Use the device only in a silicone-free environment.
- The device complies with the requirements of Directive 2014/30/EU (EMC). When using the product close to devices with radio transmitters:
 - Comply with the information in the operating instructions for the devices regarding emission of interference.
- When used in mines:
 - Use the device only in environments where there is a low risk of mechanical impacts.

1.6 Qualification of users

The appropriate specialist knowledge is required for using this product. In addition, certain activities performed with the device or on it may be performed only by qualified persons.

A distinction is made between the following user groups:

Trained person

- Trained persons know the external structure, functions and operating instructions of the devices.
- Trained persons can detect defects or changes to the device.
- Trained persons may perform device inspections. They can evaluate the results.

Specialist (device inspector)

- Specialists have received professional training and thus have fundamental knowledge of the measuring principles used in gas concentration measuring devices.
- Specialists are experienced users and therefore have sufficient knowledge of the use of gas concentration measuring devices.
- Specialists are permitted to perform device inspections and adjustments. They can evaluate the results.

Competent person

SEWERIN service personnel and people trained by SEWERIN are competent persons.

- Competent persons have knowledge of the applicable regulations and guidelines as well as the tasks and functions of gas concentration measuring devices.
- Competent persons can evaluate whether the condition of devices renders them safe to operate and can perform the necessary operations without supervision.
- Competent persons are appointed by their company in writing. Their responsibilities are defined when they are appointed. They are authorised by the manufacturer.
- Competent persons must receive regular training.
- Competent persons are permitted to perform device inspections, adjustments and maintenance.

2 Product description

2.1 Product variants

The following product variants of the device are available:

- **Ex-TEC PM 580** (for short: **PM 580**)
- **Ex-TEC PM 550** (for short: **PM 550**)
- **Ex-TEC PM 500** (for short: **PM 500**)
- **Ex-TEC PM 400** (for short: **PM 400**)

Each product variant has certain basic device features as standard. In addition, there are different device features for each product variant:

- The built-in sensors can be set up for various gas types.
- Other sensors can be installed as options.

Note:

The device features must be specified at the time of purchase.

- As a rule, optional sensors cannot generally be retrofitted.
-

2.2 Application options

2.2.1 Detectable gases

The device may be used to measure the following gases:

Gas	PM 580	PM 550	PM 500	PM 400
Methane CH ₄	x	x	x	x
Propane C ₃ H ₈	o	o	o	o
Nonane C ₉ H ₂₀	–	–	–	o
Carbon dioxide CO ₂	o	o	o	o
Oxygen O ₂	o	o	o	o
Carbon monoxide CO	o	o	o	o
Hydrogen sulphide H ₂ S	o	o	o	–
Acetylene C ₂ H ₂	–	–	–	o
Hydrogen H ₂	–	–	–	o
JFuel	–	–	–	o

x as standard, o optional, – not possible

The gases that can actually be measured with a device depend on the device features with optional sensors and on the gas types for which the device is set up.



WARNING! Risk to life from dangerous gas concentrations

Incorrect measurements may be obtained if nonane and JFuel are measured using unsuitable accessories.

If nonane and JFuel are to be measured, fit the necessary accessories:

- Use only the accessories approved for this purpose (section 9.7.2).
-

2.2.2 Applications

The following applications are differentiated for working with the device (/3/):

Application	Activities
Warning	<ul style="list-style-type: none"> – monitoring of work areas – warning of (/4/, /5/, /7/, /14/): <ul style="list-style-type: none"> – toxic gas concentrations – lack of oxygen/excessive oxygen – explosive gas concentrations
Measuring	<ul style="list-style-type: none"> – demonstrating gas purity / absence of gas in gas pipes
Structure	<ul style="list-style-type: none"> – measuring very small gas concentrations in structures. – locating the source of gas – warning of (/4/, /5/, /14/): <ul style="list-style-type: none"> – toxic CO concentrations – explosive gas concentrations

The product variants are suitable for the following applications:

Application	PM 580	PM 550	PM 500	PM 400
Warning	×	×	×	×
Measuring	×	×	–	–
Structure	×	–	–	–

× as standard, – not possible

2.3 Features

2.3.1 Sensors

The sensors included as device features depend on the product variant. The following sensors are included as standard or as options:

Sensor	Gas/gas type	PM 580	PM 550	PM 500	PM 400
IR	CH ₄ C ₃ H ₈	×	×	×	–
	CO ₂	o	o	o	o
SC	CH ₄ C ₃ H ₈	×	–	–	–
CC	CH ₄ C ₃ H ₈ C ₉ H ₂₀ C ₂ H ₂ H ₂ JFuel	–	–	–	×
EC	CO	o	o	o	o
	O ₂	o	o	o	o
	H ₂ S	o	o	o	–
	CO and H ₂ S (COSH)	o	o	o	–

× as standard, o optional, – not possible

When charging, the device shows which optional sensors are included (fig. 45).

Operating principles of the sensors

Sensor	Operating principle
IR Infrared sensor	absorption by infra-red-active gases
SC Gas-sensitive semiconductor	reacts to changes in conductivity brought about by reducible gases
CC Catalytic combustion sensor	catalytic combustion
EC Electrochemical sensor	electrochemical cell

Technical information about the sensors, including their measurement ranges, can be found in section 9.2.

Information about electrochemical sensors

Very high gas concentrations can reduce the lifetime of electrochemical sensors.

Information about semiconductor sensors and catalytic combustion sensors

These sensors are sensitive to external influences.

- Oxygen-deficient atmospheres can reduce the sensitivity of the sensor (sensor suffocation).
- Gaseous components of silicones, oils and phosphate esters etc. can irreversibly damage the sensor.
- Contamination of the measuring environment with halogens, burnt neoprene, PVC, trichloroethylene etc. will also reduce the sensitivity of the sensor. However, the sensor can usually regenerate itself during further operation.

2.3.2 Gas types

By default the device is set up for gas type methane CH₄.

However, the sensors fitted to a device as standard (section 2.3.1) can be set up for other gas types or for additional gas types.

The following gas types can be set up:

Gas type	PM 580	PM 550	PM 500	PM 400
CH ₄	×	×	×	×
C ₃ H ₈	○	○	○	○
C ₉ H ₂₀	–	–	–	○
C ₂ H ₂	–	–	–	○
H ₂	–	–	–	○
JFuel	–	–	–	○

× as standard, ○ optional, – not possible

The gas types can be set up:

- when the device is purchased
- subsequently using **GasCom** software¹

You can switch between all gas types for which a device is set up during operation (section 3.7).

2.3.3 Visual and audible signals

2.3.3.1 Overview

The device can emit the following signals:

- visual signal (via the signal light)
- audible signal (via the buzzer)

¹ The new gas type is available in the device only when an adjustment has been performed after setting up.

Visual and audible signal together:

- Alarm
- Operating signal
- Error (error message)
- Device inspection or inspection due²
- Warning, information
- Switching the device on and off
- Concentration-dependent signal

Visual signal only:

- Paused measurement

Audible signal only:

- Keystroke³

Note:

In the event of an alarm or fault, the visual signal is emitted with full brightness; in the event of a paused measurement, it is emitted with reduced brightness.

2.3.3.2 Signal for paused measurement

When the device is in a state in which it cannot measure⁴, a continuous visual signal is emitted.^{5,6} The signal light illuminates with reduced brightness.

² Signals when device inspections are due are emitted only if the guided device inspection has been activated using the **GasCom** software.

³ The audible signal can be disabled using the **GasCom** software.

⁴ "special status" as per /8/.

⁵ Does not apply if a fault occurs. The signal of the fault then supersedes the signal of the paused measurement.

⁶ The signal of the paused measurement can be disabled using the **GasCom** software. For devices with a disabled signal, the functional safety test (type-examination certificate issued by DEKRA Testing and Certification GmbH) does not apply.

The signal for paused measurement is emitted:

- when the device is switched on
- during the warm-up time of the sensors
- when the device is not measuring (e.g. **settings, adjustment**)

2.3.3.3 Operating signal

Note:

An operating signal is available only in the **Warning** and **Structure** applications.⁷

The operating signal indicates that the device is working properly. The signal is emitted regularly every 20 seconds.

The operating signal output is interrupted while there are faults.

2.3.3.4 Alarm signals

Warning alarms are emitted if the concentration of one or more gases exceeds certain limit values (alarm thresholds).



WARNING! Risk to life from dangerous gas concentrations

An alarm always indicates danger.

- Immediately take all necessary measures for your own safety and the safety of others.

The concrete measures depend on the situation.

- In the event of a pre-alarm **AL1** it may be sufficient to ventilate thoroughly.
 - In the event of a main alarm **AL2** it may be necessary to leave the danger zone immediately.
-

⁷ The operating signal of a device can be disabled using the **GasCom** software. For devices with a disabled operating signal, the functional safety test (type-examination certificate issued by DEKRA Testing and Certification GmbH) does not apply.

Acknowledgement:

Under certain conditions, the audible signal can be muted during alarms. In some measurement situations, the visual signal and symbol can also be deactivated. The process is referred to as acknowledgement.

Detailed information about the alarms, including the acknowledgement options, can be found in section 9.4.

2.3.3.5 Signals in the event of faults

In the event of error messages, the audible signal can be acknowledged/disabled, but not the visual signal.

The operating signal output or the signal during paused measurement is interrupted while there are faults.

2.3.4 Display illumination

The display has a backlight. When the device is switched on, the display will automatically switch on when any key is pressed.

The period of illumination can be changed using the **GasCom** software.

2.3.5 Gas input and filter

The test gas or ambient air is drawn in using the pump via the gas inlet.

In certain cases and in certain situations of measurement, accessories are connected to the gas input, for example:

- test gas hose of the test set **SPE AutoFlow**
- conditioner
for humidifying the gas that is sucked in
- CO2 filter

The gas that is sucked in flows through two filters directly behind the gas input. The filters prevent contamination or moisture from entering the device and thus reaching the sensitive sensors.

- dust filter
traps solids, particularly dusts
- hydrophobic filter
serves as a water barrier



Fig. 5: Hydrophobic filter (left) and dust filter (right)

The filters must be changed regularly. Information on the frequency and procedure for changing can be found in section 3.11.

2.3.6 Belt clip and short probe

The device comes with a belt clip and the **PM 5 short probe**. The short probe is placed in a recess in the belt clip.

Belt clip

The user can wear the device on the belt clip attached to the belt or to the trouser waistband. Textile loops or the like can be passed through the D-ring of the belt clip.

PM 5 short probe

The short probe can facilitate the taking of the gas sample in certain situations, e.g. when searching for leaks.

The short probe is connected to the gas input.



Fig. 6: PM 5 short probe

2.4 Additional probes

Various probes can be connected to the gas input of the device. The choice of a suitable probe depends on the application and the situation on site.

The **PM 5 short probe** is included in the scope of delivery (section 2.3.6). Other probes can be purchased as accessories. SEWERIN will be happy to advise you on selecting suitable probes.

Note:

Probes that are used must be visually inspected as part of the device inspection process. In addition, the leak-tightness of the gas path must be checked regularly (section 3.10).

2.5 Measuring mode and menu

When switched on the device is automatically in measuring mode. In measuring mode, the current measurements are still displayed.

In the **Structure** and **Measuring** applications a maximum of two measurement values are displayed; in the **Warning** application up to five measurement values can be displayed. The display view in measuring mode therefore depends on the application (fig. 3 and fig. 4).

You can switch from measuring mode to the menu. Whether the top menu level or the measuring menu appears after the change depends on which key is pressed in measuring mode. The measurement menu is part of the menu.

In the menu the user can:

- Perform actions
- Perform settings
- View information

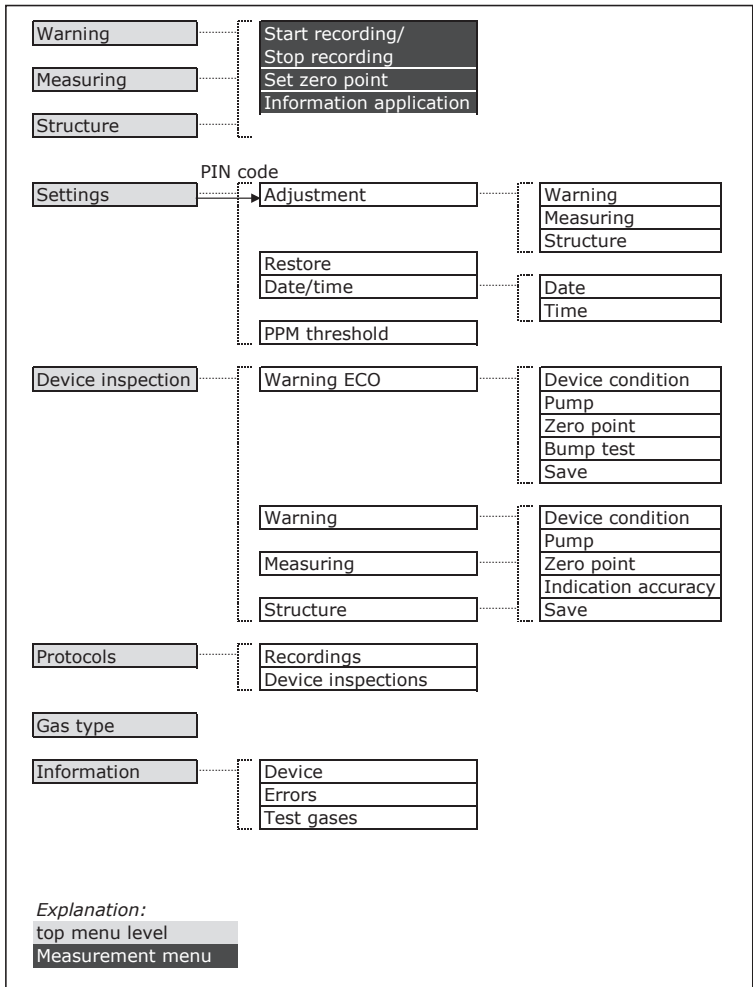

Fig. 7: Menu structure for the first three menu levels⁸

⁸ The **Device inspection** (top menu level) is available only if the guided device inspection has been activated using the **GasCom** software.

2.6 Units for concentration data

2.6.1 Selectable units (warning)

In the **Warning** application, the measurement value for the flammable gases can be displayed with either % LEL or % vol. as the unit.

The device is supplied set to the % LEL unit. The unit can be changed using the **GasCom** software.

	0 CH4 %LEL	0.04 CO2 %VOL		0.00 CH4 %VOL	0.04 CO2 %VOL
	0.0 H2S PPM	20.9 O2 %VOL		0.0 H2S PPM	20.9 O2 %VOL
	0 CO PPM			0 CO PPM	

Fig. 8: **Warning** application – measurement value of flammable gas (here: CH₄) with different units

Left image: Unit % LEL

Right image: Unit % vol.

2.6.2 Conversion of the concentration data

Gas concentrations are specified in the unit ppm (parts per million) or % vol. (volume percent).

Conversion: 1 % vol. = 10,000 ppm
 0.1 % vol. = 1,000 ppm

3 Operation

3.1 Switching on the device



WARNING!

Risk to life due to contaminated ambient air

If the device is switched on in a contaminated environment¹, incorrect measurement values may be displayed in measuring mode.

- Switch on the device only in clean air.
-

Each switch-on process is linked to activation of the buzzer, signal light and display. This allows the user to check the following device functions:

Buzzer: Is the audible signal working?

Signal light: Is the visual signal working?

Display: Can incorrect pixels be seen in the inverse display?



WARNING!

Risk to life if device functions are faulty or missing

Checking the device functions at switch-on is necessary for the safety of the user.

- Monitor the device carefully during the switch-on process.
 - Cancel the switch-on process if the check of any one of the device functions is unsuccessful.
-

¹ E.g. contamination with flammable hydrocarbons.

Note:

If the message **Start sensors ...** appears, it means the sensors are still warming up. During this warm-up time, the signal will be emitted for the paused measurement. In addition, no action can be performed.

1. Make sure the ambient air is clean.
2. Hold down the ON/OFF key until the device reports with a visual and audible signal. The device function self-test has started.
 - a) A sequence of start images appears (fig. 9). The signal for the paused measurement is emitted.
 - b) If device inspections and checks are due, this will be displayed² (fig. 10).
 - c) For the preset application, the gas types including their measuring ranges and the alarm thresholds are displayed (fig. 11). The information is generally spread over several display views.
 - d) The sensors are warmed up.

During the warm-up, the display view of the measuring mode is shown with animated squares.

The **Start sensors ...** message may also appear depending on the situation.
3. Wait until all measurement values are displayed.

The signal for the paused measurement is stopped. The device is in measuring mode.
4. Perform all device inspections that are due.

The device is now ready for use. The displayed measurement values correspond to the zero point when the device has been switched on in clean air and is not de-adjusted.

² The device inspections that are due will be displayed only if the guided device inspection has been activated using the **GasCom** software.



Fig. 9: Sequence of start images during switch-on process
The logo can be customised using the **GasCom** software.

!	Device inspection	
		25.05.19
		23.05.19
		30.05.19
	Inspection	
		12.03.19

Fig. 10: Display of the device inspections that are due and the inspection that is due
(Only displayed if the guided device inspection is activated and a device inspection or inspection is due.)

	CO2	2.00 ... 5.00 %VOL
		0.50 %VOL
		2.00 %VOL
		5.00 %VOL
		1.00 %VOL
		0.50 %VOL

Fig. 11: Indication of gases, measuring ranges and alarm thresholds (here: **Warning** application, gas CO₂)



 	0 CH4 %LEL	0.04 CO2 %VOL	
	0.0 H2S PPM	20.9 O2 %VOL	
	0 CO PPM		

Fig. 12: Device ready for use with the preset application (here: Warning application)

Special features at initial start-up

The language must be set once at initial start-up.

The setting is performed in association with the start images (fig. 9).

Special feature when changing the disposable batteries/ rechargeable batteries

Once the batteries have been changed the battery type and if necessary the date and time must be reset.

The settings are made before the start images appear (fig. 9).

3.2 Switch off device

The device switch-off process lasts approx. 3 seconds. During the switch-off process, the display shows:

- Message **Device switching off ...**
- Progress bar

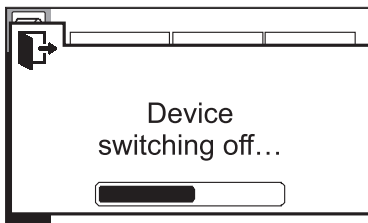

Fig. 13: Display during switch-off

- Hold down the ON/OFF key until the message has disappeared.

Cancel switch-off

Whilst the message **Device switching off ...** is displayed, the switch-off process can be cancelled.

- Release the ON/OFF key before the message disappears. The device returns again to measuring mode.

3.3 Navigating

3.3.1 Orientation aids on the display

By means of orientation aids the user can identify the program situation in which the device finds itself or what action is required.

The display offers the following orientation tools:

- Information area
- Status area
- Messages

Information area

The information area is at the left edge of the display.

The current application is displayed in measuring mode with symbols, otherwise the selected menu level is displayed.



Fig. 14: Information area (grey)

Left image: Information area at the left edge

Alongside: Examples of orientation using symbols (*here: Settings > Date/Time > Time*)

Status area (measuring mode only)

In measuring mode, the information area is partly covered by the status area.

The symbols in the status area give an indication of the current situation. The remaining battery capacity is always displayed.

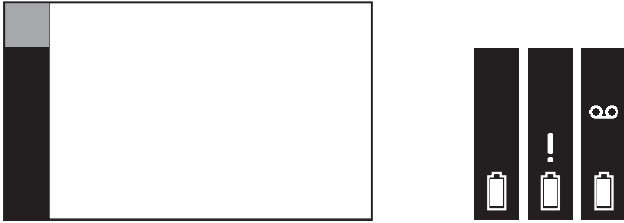

Fig. 15: Status area (black)

Left image: Status area above the information area

Alongside: Examples of information about the current situation
(*here: Remaining capacity, Device inspection due, Recording*)

Messages

To a large extent the messages cover the information underneath them.

Messages contain texts explaining a program situation or asking for action.

The most important messages are:

- Warning
- Errors
- Question
- Information

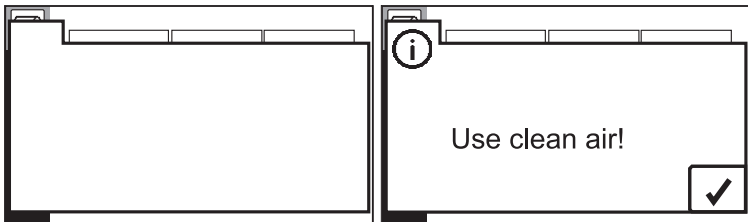





Fig. 16: Message

Left image: The message covers the information underneath it.

Right image: Example (*here: Information Use clean air!*)

3.3.2 Key functions

The following actions can be performed using the keys:

Key	Actions
	<ul style="list-style-type: none">● Switching<ul style="list-style-type: none">– the device on and off
	<ul style="list-style-type: none">● Changing<ul style="list-style-type: none">– from measuring mode to the top menu level– back a menu level● Cancel<ul style="list-style-type: none">– an action, a process
	<ul style="list-style-type: none">● Changing<ul style="list-style-type: none">– from measuring mode to measuring menu– to a submenu level● Confirm/apply<ul style="list-style-type: none">– a selected menu item– a message– a value
	<ul style="list-style-type: none">● Select<ul style="list-style-type: none">– a menu item– a value● Acknowledge<ul style="list-style-type: none">– an alarm● Change<ul style="list-style-type: none">– a default setting, e.g. for questions

Switch the display backlight on

The device must be switched on. When pressing any key, the display will automatically switch on.

3.3.3 Switch between levels

3.3.3.1 Changing from measuring mode to menu or measuring menu



WARNING!

Risk to life due to absence of alarms

The device emits alarms only when in measuring mode. As soon as you switch from measuring mode to the menu, no alarms are triggered.

- Switch from measuring mode to the menu only in environments that are not explosive and where there is no toxic or low-oxygen atmosphere.
-

Switch to the menu

The device is in measuring mode.



- Press the Menu key. The device switches to the top menu level.

Switch to the measuring menu

The device is in measuring mode.



- Press the Enter key. The device switches to the measurement menu.

3.3.3.2 Switch from menu or the measuring menu into measuring mode

The display shows the top level menu or the menu (fig. 7).

- Wait 5 seconds without pressing a key. The device will automatically switch to measuring mode.

OR



1. Using the arrow keys, select an application.



2. Press the Enter key. The device switches to measuring mode.

3.3.3.3 Select a menu item in a menu

The device shows a menu.



1. Using the arrow keys, select the desired menu item.



2. Press the Enter key. The menu item appears.

3.3.4 Cancel the action or process

An action is performed or a process is running.



- Press the Menu key. The action or a process is cancelled. The device switches back one menu level.

3.3.5 Scrolling

If lists, information etc. are so large that they cannot be displayed on a display view, a narrow scroll bar appears at the right-hand edge.

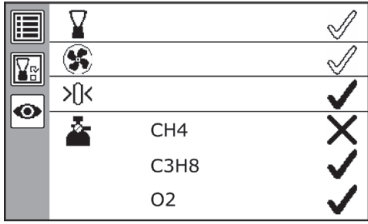

Fig. 17: Example of display view with scroll bar at the right margin (*here*: Protocol of a device inspection)

The display view has a scroll bar.



- Press the arrow keys to scroll.

3.3.6 Select values

Values must be selected for certain settings. Entering the PIN code also works in this way.

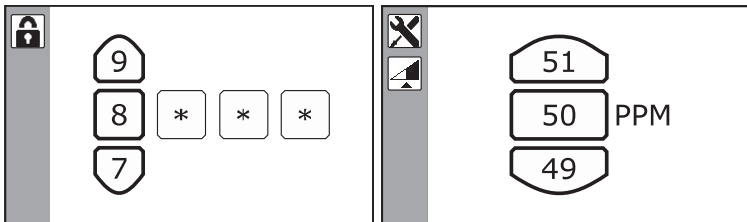

Fig. 18: Examples of selecting values

Left image: Entering the PIN code for the settings

Right image: PPM threshold

The program situation requires the selection of values. The individual fields are changed from left to right.



1. Select the desired value in the first field using the arrow keys.



2. Press the Enter key. The value is applied.



3. Repeat the selection for all subsequent fields.



- Once the last value has been applied, the device switches back a level.

3.3.7 Answer questions

Questions appear in the program procedure if actions have further consequences and during the device inspection. The following responses are possible:

Note:

Questions have different default settings for the answer.

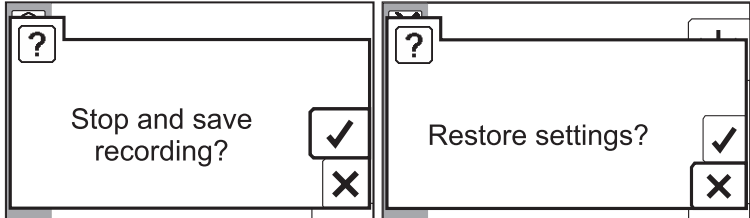

Fig. 19: Examples of questions

Left image: Question with the default answer **Yes**

Right image: Question with the default answer **No**

The display shows a question.

1. Check the default answer setting.

(▲ ▼) 2. Select the other response if necessary using the arrow keys.



3. Press the Enter key. Depending on the response selected, the action is performed or not performed.

3.3.8 Lists - view detailed information

Protocols and information are stored in lists. The relevant detailed information can be displayed for each entry in a list.

The display shows a list (e.g. fig. 36).



1. Using the arrow keys, select the relevant entry.



2. Press the Enter key. The detailed information about the entry will be displayed.

3.3.9 Write comment

Comments are information that can be saved together with the measurement values of a recording (e.g. information about the measurement location).

Comments can always be rewritten or selected from a list of the last 10 comments (fig. 20).

If a comment is selected from the list, it can either be accepted unchanged or modified.

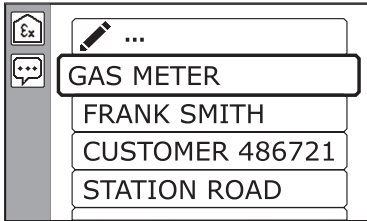

Fig. 20: List of comments
top line: write new comment
(Write symbol)
below: existing comments

A comment can contain letters, spaces, numbers and special characters (dot, comma, dash). The entry can be a maximum of 20 characters long.

To write a comment, characters from a sequence of preset characters are selected.

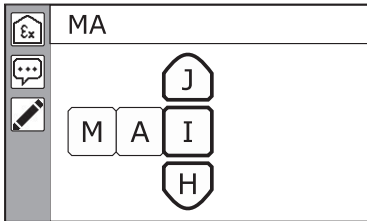

Fig. 21: Write comments using
character selection
horizontal: string with 2 applied
and 1 selected characters
vertical: character selection
at the top edge: preview of string

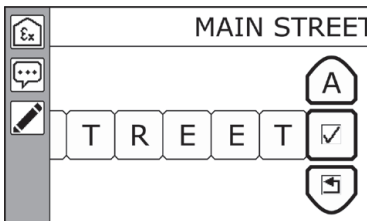









Fig. 22: Apply written comment
using the Confirm symbol

Keys and symbols are used to navigate in the character selection. The symbols are integrated into the character selection.

The following keys and symbols can be written:

Key	Actions
	<ul style="list-style-type: none"> • Select <ul style="list-style-type: none"> – a character or symbol
	<ul style="list-style-type: none"> • Use <ul style="list-style-type: none"> – a character • Trigger <ul style="list-style-type: none"> – actions associated with the symbols • Move <ul style="list-style-type: none"> – to the right
	<ul style="list-style-type: none"> • Move <ul style="list-style-type: none"> – to the left

Symbol	Actions
	<ul style="list-style-type: none"> • Use <ul style="list-style-type: none"> – the entire comment The comment will be saved together with the recording.
	<ul style="list-style-type: none"> • Cancel <ul style="list-style-type: none"> – the character entry The device returns to the list of comments.
	<ul style="list-style-type: none"> • Insert <ul style="list-style-type: none"> – a character in front of an existing character
	<ul style="list-style-type: none"> • Delete <ul style="list-style-type: none"> – a character

3.4 Start, stop, save recording

In measuring mode, the device continuously displays the current measurement values. If these measurement values are to be saved, they must be recorded. This is done using:

- **Start recording**
- **Stop recording**

Each recording is automatically saved when it stops and is then listed in the protocols. A comment can be saved for each recording together with the measurement values.

3.4.1 Start recording

The device is in measuring mode.

1. Press the Enter key. The device switches to the measurement menu.
2. Select **Start recording**.
3. Press the Enter key. The device returns back to measuring mode. The recording is running.

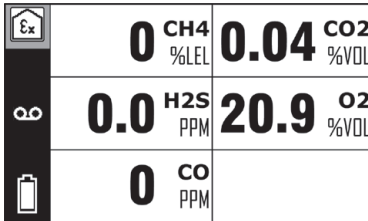



	0 CH4 %LEL	0.04 CO2 %VOL
	0.0 H2S PPM	20.9 O2 %VOL
	0 CO PPM	

Fig. 23: Measuring mode (here: **Warning** application) on the left (status area): **Recording** symbol (while recording is running)

3.4.2 Stop recording and save without a comment

The device is in measuring mode. A recording is running.

1. Press the Enter key. The device switches to the measurement menu.
2. Select **Stop recording**.
3. Press the Enter key. The following question appears:
Stop and save recording?
4. Confirm the question. The following question appears:
Add comment?
5. Select **Cancel**.
6. Press the Enter key. The recording is saved without comment. The device returns back to measuring mode.

3.4.3 Stop recording and save it with a comment

The device is in measuring mode. A recording is running.

1. Press the Enter key. The device switches to the measurement menu.
2. Select **Stop recording**.
3. Press the Enter key. The following question appears:
Stop and save recording?
4. Confirm the question. The following question appears:
Add comment?
5. Confirm the question. The list of comments will appear (fig. 20).
6. Write a comment.

Information about writing comments can be found in section 3.3.9.

7. Load the comment.

To do so, select the **Confirm** symbol in the drawing selection (fig. 22).

The recording is saved with a comment. The device returns back to measuring mode.

3.5 Change application

In measuring mode, the symbol in the upper left corner of the display shows the current application.



Fig. 24: Measuring mode (*here: Measuring application*)
top left (information area): Symbol of the current application



WARNING! Risk to life from using miscalibrated or faulty devices

A device inspection must be performed regularly when the device is used as a gas warning instrument. This applies both when the **Warning** or **Structure** application is preset and when switching to one of these applications from another application.

- Perform the device inspections in accordance with the national specifications. For more information, refer to section 6.4.2.



CAUTION! Danger due to delayed alarm

When the application is changed, the calculation of STEL and LTEL restarts.

Requirement for changing the application

- The device is drawing in clean air.

The device is in measuring mode.

1. Press the Menu key.
2. Use the arrow keys to select the desired application.

3. Press the Enter key.

For the new application, the gas types including their measuring ranges and the alarm thresholds are displayed.

The device switches to measuring mode.

4. Wait until all measurement values are displayed. The device is now ready for use.

3.6 Set zero point

If the measured values deviate from the target values for clean air (table to fig. 25), the zero point can be reset temporarily.

The zero point is set temporarily for each separate application. This means that only the gases used in the application are set to the target value.

In contrast to performing a zero point adjustment, the temporarily set zero point is not saved.

Note:

If the zero point deviates repeatedly from the target values, adjust the device.

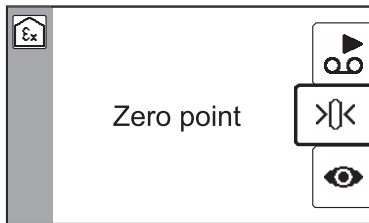

Fig. 25: Set zero point

Target values for the zero point

Gas	Content in clean air	Target value on the device
CH ₄	0% LEL	0% LEL
CO ₂	0.04% vol.	0.04% vol.
O ₂	20.9% vol.	20.9% vol.
CO	0 ppm	0 ppm
H ₂ S	0.0 ppm	0.0 ppm

Requirements for setting the zero point

- The device is switched on in clean air.
- The device is drawing in clean air.
- The sensors are warmed up.

The device is in measuring mode. The measurement values deviate from the target values.

1. Press the Enter key.
2. Select **Set zero point**. A question appears.
3. Confirm the question. The zero point is set. The device returns back to measuring mode. The measured values in clean air correspond to the target values.

If the zero point cannot be set successfully, you will find information in section 8.3.2 about how to solve the problem.

3.7 Changing gas type

The device always switches on set to the preset gas type. During operation you can temporarily switch between all gas types for which a device is set up.

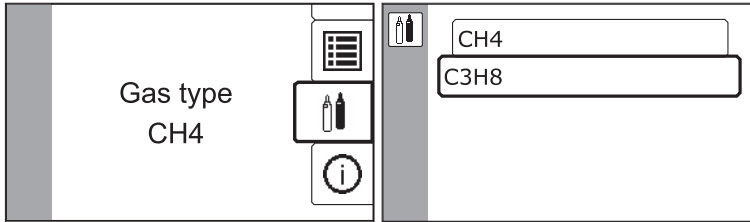

Fig. 26: Changing gas type

Left image: Gas type **menu item**

The current gas type is displayed in the 2nd line
(*here: CH₄*).

Right image: List of the available gas types

Note:

If the **Device inspection due** symbol appears in the status area after the gas type has been changed, this must be performed immediately.

Requirement for changing the gas type

– The device is drawing in clean air.

The device is in measuring mode.

1. Press the Menu key.
2. Select **Gas type**.
3. Press the Enter key. The list of available gas types appears.
4. Select the relevant gas type.
5. Press the Enter key. The device first returns a menu level and then switches to measuring mode. The device uses the selected gas type.

3.8 Changing the settings on the device

Some settings can be changed directly on the device.



Fig. 27: Settings

Detailed information about the settings that can be changed on the device can be found in section 4.3.



WARNING!

Risk to life due to absence of alarms

The device emits alarms only when in measuring mode. As soon as you switch from measuring mode to the menu, no alarms are triggered.

- Adjust settings only in environments where there is no risk of explosion and where there is no toxic or low-oxygen atmosphere.
-

The device is in measuring mode.

1. Press the Menu key.
2. Select **Settings**. The PIN prompt appears.
3. Enter the PIN code. The settings will appear.
4. Select the desired menu item.
5. Change the settings.
6. Press the Enter key. The changed settings will be applied.
7. Press the Menu key to apply the **Settings**.

3.9 Concentration-dependent signal (structure)

In the **Structure** application, there is a concentration-dependent signal for the measurement of hydrocarbons. This signal can be used for audible evaluation of the measurement value.

The signal is activated when a specified concentration value is exceeded.

- As the concentration increases, the signal becomes louder.
- If the concentration drops, the signal becomes quieter again.

The triggering concentration value is set at the **PPM threshold** (section 4.3.5).

When the **AL1** alarm threshold is exceeded, the concentration-dependent signal switches off.

Note:

The operating signal is interrupted during the concentration-dependent signal.

When the concentration-dependent signal is triggered, the device emits both a visual and an audible signal. The audible signal can be switched off.

Switch off the audible signal

The device is in measuring mode. The concentration-dependent signal was triggered.

- Press one of the arrow keys. The audible signal switches off. The **Audible signal off** symbol appears in the status area. The operating signal is emitted.

Switch on the audible signal

The device is in measuring mode. The concentration-dependent signal was triggered. The audible signal is switched off. The status area displays the **Audible signal off** symbol.

- Press one of the arrow keys. The audible signal switches on again. There is no operating signal.

3.10 Leak test when using probes

If the device is used with probes, the leak-tightness of the gas path and the probe or probe hoses must be checked regularly.

The gas path at the gas inlet is sealed off for the test. The device must respond to this with an error message.

Frequency

The leak test must be performed at least quarterly.

Special features

- **Flexible probe HG5, flexible hand probe**

Before the test, the filter cap must be unscrewed and the filter removed.

If the filter does not exhibit any visible contamination, it can be reinserted after the test. The original orientation must be maintained.

- **Floating probe**

The test is performed not at the probe but at the end of the probe hose connected to the device.

Check the leak-tightness

A probe or a probe hose is connected to the device. The device is in measuring mode.

1. Seal the probe or the probe hose at the free opening, e.g. with a finger.

The gas path is leak-tight if the following error message appears after a maximum of 10 seconds: **Pump error. Check suction path.***

2. Unblock the sealed opening again.

3.11 Changing the filter

The filter seal seals the filter opening. The dust filter is located in the filter seal, the hydrophobic filter is located in the filter opening (fig. 28).

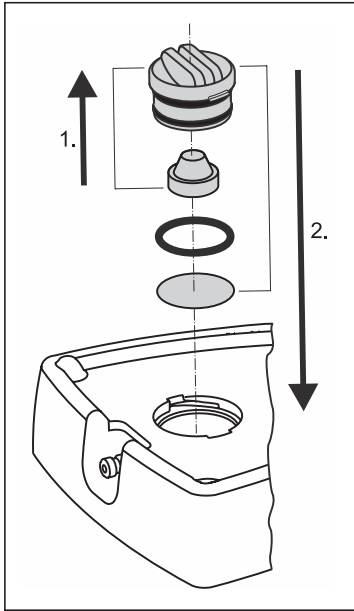

Fig. 28: Position of filters (schematic representation)

from top to bottom:
Filter fastener with 2 O-rings
Dust filter
O-ring
Hydrophobic filter

The filter fastener has lugs of two different widths. It is a close fit in the filter opening.

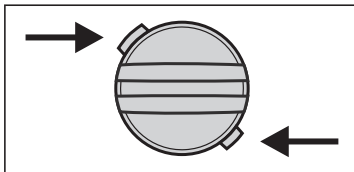

Fig. 29: Filter fastener with lugs of two different widths (view from above)

Frequency

The frequency of the filter replacement is greatly dependent on the frequency of device usage and the ambient conditions during use.

The filters must be replaced if they exhibit:

- visible contamination
- mechanical damage
- contact with water

If none of the events occurs, the filters must be replaced after 12 months at the latest.

Checking the filters

The dust filter contamination can be tested from the outside by inspection through the transparent filter fastener.

To check the condition of the filters more precisely, the filter fastener must be unscrewed.

Note:

Once a hydrophobic filter has been taken out it must not be replaced.

Recommended tools

- Coin
for turning the filter fastener
- Tweezers
for removing and inserting the hydrophobic filter and O-ring

Changing the filter

NOTICE! Risk of contamination

New filters, i.e. filters not yet used, must be handled carefully to prevent mechanical damage.

Filters and O-rings must not come into contact with grease.

- Ensure your hand are clean when changing the filters.
 - Use tweezers to insert the hydrophobic filter.
-

The device is switched off.

1. Turn the filter fastener anti-clockwise until it reaches the stop.
2. Pull off the filter fastener.
3. Within the filter fastener: Change the dust filter
 - a) Remove the used dust filter.
 - b) Insert a new dust filter. Press the filter gently into the filter fastener.
4. Within filter opening: Replace the hydrophobic filter
 - a) Remove the O-ring above the filter, taking care not to damage it.
 - b) Remove the used hydrophobic filter.
 - c) Carefully insert a new hydrophobic filter.
 - d) Replace the O-ring.
5. Replace the filter fastener. Make sure the side lugs are correctly oriented.
6. Turn the filter fastener clockwise until it reaches the stop.

4 Settings

4.1 General information about the settings

A distinction is made between the following settings:

- Settings that can only be set using the **GasCom** software
- Settings that can be set either on the device or using the **GasCom** software

When a device is connected to a computer on which the **GasCom** software is started:

- The current settings of the device can be read out and edited in the software.
- Settings made using the software must be transferred to the device.

4.2 Settings using the GasCom software

Most settings for the device are made on the computer using the **GasCom** software.

They include:

- Specifying the application at switching on
- Activating/deactivating the guided device inspection
- Alarm thresholds
- Signals
- Measurement interval
- Setting the units for measuring flammable gases in the **Warning** application
- Changing gas type
- Managing test gases
- Managing protocols



WARNING! Danger of unchecked settings

When using the device as a gas warning device, the settings set using **GasCom** software must be checked after they have been applied to the device (/8/).

- Check the settings on the device.

OR

- Check the settings in the **GasCom** software. To do so, read the device data again using the **GasCom** software.
-

The **GasCom** software can be downloaded free of charge from www.sewerin.com.

4.3 Settings on the device

The following settings and actions can be performed on the device:

- **Adjustment**
- **Restore**
- **Date/time**
- **PPM threshold** (only for the **Structure** application)

4.3.1 Access to the settings using PIN code

The settings on the device are PIN code protected.

The device is delivered with the PIN code “0001”. The PIN code can be changed using the **GasCom** software.

SEWERIN recommends changing the PIN code after initial start-up, so that only authorised users have access to the settings.

With the digits “0000” the settings are not PIN code protected.

4.3.2 Adjustment

Adjustment is a maintenance-related activity.

Detailed information about carrying out the adjustment can be found in section 6.5.

4.3.3 Restore

The device can be restored to the status as at the time of the last maintenance.¹

The following settings are saved every time they are serviced and can therefore be restored:

- Adjustment values of the sensors
- Alarm thresholds
- Application and gas type after switching on
- PIN code

The settings to be restored cannot be reset individually. All of the above settings will be reset together.

When the **Restore** menu item is selected, a warning prompt appears to prevent accidental resetting.



WARNING!

Danger with changed settings or sensor ageing

After each restore the following steps are required:

- Perform a device inspection.
 - Check the selected measuring ranges and alarm thresholds when switching on or under **Information application**.
-

4.3.4 Date/time

The date and time of the device are used to record the protocols, information and maintenance activities.

Note:

Ensure that the date and time are set correctly at all times so that for example recordings from different devices can be compared with each other.

¹ Before the device is first serviced a restore will restore the condition at delivery.

The date and time of the device are set in two separate menu items.

- **Date** (day, month, year)
- **Time** (time of day)

4.3.5 PPM threshold

The threshold value can be set for the concentration-dependent signal in the **Structure** application.

The options are:

- – | **10** | **20** | ... | **100 ppm**

If the concentration-dependent signal is to be disabled, "-" must be selected.

Information about the concentration-dependent signal can be found in section 3.9.

5 Protocols and information

5.1 Protocols

The following protocols can be displayed:

- **Recordings**
Protocols of recordings
- **Device inspections**
Protocols of device inspections

A maximum of 40 protocols per type are stored in two separate ring memories.

Note:

When the storage space in the ring memories is full, the oldest protocol is automatically overwritten with the current protocol. Protocols that have been overwritten cannot be displayed or backed up.

- Back up the protocols regularly and in a timely manner using the **GasCom** software.

Protocols can be deleted using the **GasCom** software.

Note:

The detailed information about a protocol is generally spread over several display views.

- Scroll using the arrow keys to view the complete information.
-

Protocols of recordings

The protocols of the recordings are listed in descending order of date. If a comment has been saved for a recording, it will appear before the date on the first line.

The protocol of a recording includes:

- Application (symbol)
- Date, start and end of recording
- Comment (optional)
- Gases with the minimum and maximum measurement values

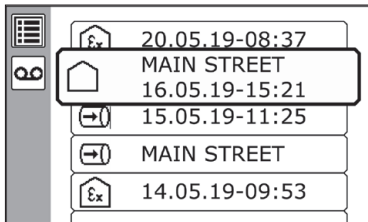

Fig. 30: Protocols - list of recordings

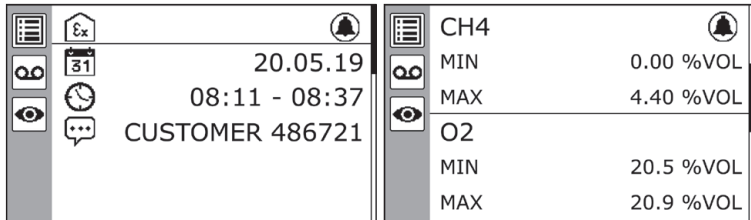

Fig. 31: Protocol of a recording

The information is spread over several display views.

Protocols of device inspections

Note:

The device not only saves the guided device inspections, but also all the device inspections performed using the **ATS** test set.

The device inspections protocols are listed in descending order of date. The device inspection result is displayed for each entry.

The protocol of a device inspection includes:

- Application (symbol)
- Overall result (symbol)
- Save date
- Inspector
- Results of the tests (device condition, pump, zero point, tested gases)

Ex	24.05.19-07:28	✓
Ex	23.05.19-08:09	✓
Ex	23.05.19-07:31	✓
Ex	23.05.19-07:25	✗
Ex	22.05.19-07:46	✓

Fig. 32: Protocols - list of device inspections

Ex	✗
21.05.19	
07:51	
Frank Smith	
Ex	✓
Ex	✓
Ex	✓
Ex	✗
Ex	✓
Ex	✓

Fig. 33: Protocol of a device inspection

The information is spread over several display views.

5.2 Information

The following information can be displayed:

- **Device**
Information about the device
- **Errors**
Error list
- **Test gases**
Information about test gases
- **Application**
Information about the measuring ranges and alarm thresholds of the applications

Note:

The information is generally spread over several display views.

- Scroll using the arrow keys to view the complete information.
-

Information about the device

The following information is always displayed:

- Microcontroller firmware version
- Set battery type
- Next servicing
- Built-in sensors with installation date and service life (2nd digit: expected lifetime)













		V1.003		HL	PPM
		V1.000			02.04.19
		Recharg. batt.			24/36 Months
		03.04.20		IR CxHy %LEL	
					02.04.19
					24/60 Months

Fig. 34: Information - device

The information is spread over several display views.

Error list

The last ten errors are listed in the error list in descending order of date. The following are displayed for each error:

- Date and time
- Error code
- Description of the error and remedy



	100		23.05.2019-13:50
	Pump error. Check suction path!		
	7		21.05.2019-11:38
	Sensor not adjusted: EC Adjust device!		

Fig. 35: Information - error list

Information about test gases

The information about test gases lists the available test gases.

The detailed information about a test gas shows the composition.

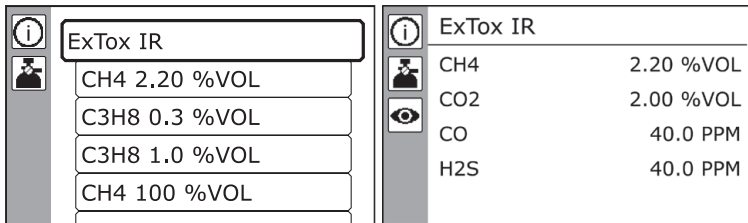

ExTox IR	
CH4	2.20 %VOL
C3H8	0.3 %VOL
C3H8	1.0 %VOL
CH4	100 %VOL

ExTox IR	
CH4	2.20 %VOL
CO2	2.00 %VOL
CO	40.0 PPM
H2S	40.0 PPM

Fig. 36: Information - test gases

Left image: List of available test gases

Right image: Composition of a selected test gas

Information about the application

The following information is always displayed:

- Gas types
- Measurement ranges
- Alarm thresholds

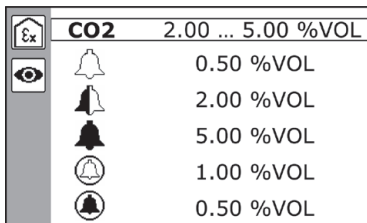

CO2		2.00 ... 5.00 %VOL
		0.50 %VOL
		2.00 %VOL
		5.00 %VOL
		1.00 %VOL
		0.50 %VOL

Fig. 37: Information - application
Display of gases, measuring ranges and alarm thresholds for a single application (*here: Warning application, gas CO₂*)

Note:

Information about the application is different from other information as follows:

- The information will appear automatically for the preset application each time the device is switched on.
 - The information is accessed from the menu (select application > **Information application**).
-

6 Maintenance

6.1 Scope of maintenance (overview)

The maintenance of the device consists of the following activities:

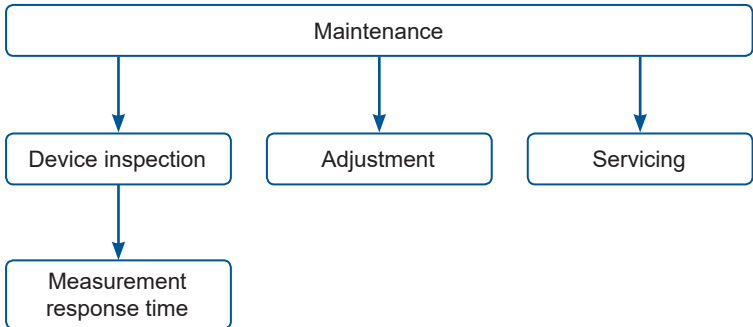

Fig. 38: Maintenance activities

The frequency and performers of the individual activities vary. For detailed information, refer to the following sections.

All maintenance activities must be documented.

In accordance with /14/, SEWERIN recommends: Find out about the procedures for checking portable devices in /15/.

Note:

In addition, these operating instructions describe only the device inspection and adjustment, since servicing

6.2 Test gases

6.2.1 Utilisable test gases

Both gas mixtures and individual gases can be used for device inspection and adjustment. With some test gases, particularly gas mixtures, several gases can be tested or adjusted simultaneously.

Test gases can be both preset and self-set.

Preset test gases

Test gases are preset in condition at delivery. These SEWERIN test gases can be used to perform all the required device inspections and adjustments.

Information about the preset test gases can be found in section 9.3.1.

Self-set test gases

Test gases other than preset test gases can be used provided they meet the listed specifications. The test gases that are not preset must be set up by the user by means of the **GasCom** software. The test gas specifications are available on request.

6.2.2 Available test gases

Available test gases can be both preset and set-up test gases.

The test gases available for maintenance are always listed at the start of an activity. The device also shows which gases can be tested or adjusted with a test gas.

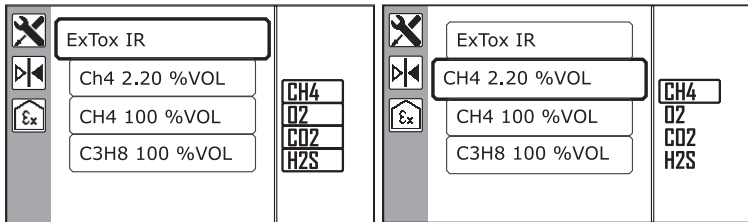

Fig. 39: Adjustment – selection of the test gas

Middle: List of available test gases

At the right edge: List of gases to be adjusted

The gases that can be tested and adjusted with a selected test gas are outlined.

Left image: All gases can be adjusted using the selected test gas.

Right image: One gas can be adjusted using the selected test gas.

6.2.3 Gas mixtures for adjusting devices with a COSH sensor

Note:

CO and H₂S levels can be measured concurrently using the COSH sensor.

The following information only refers to devices with a COSH sensor and only for the adjustment of CO with certain gas mixtures.

If a gas mixture containing 40 ppm H₂S (e.g. ExTox IR) is used as a test gas for adjusting devices with a COSH sensor, a deviation of up to -10% (i.e. -4 ppm) CO could occur. If a higher degree of accuracy is required, additional adjustment using a test gas which contains no H₂S (e.g. ExCOx IR) must be carried out subsequently.

Detecting a COSH sensor

Devices with a COSH sensor can be identified in the following ways:

- Both CO and H₂S are displayed when the device is switched on (fig. 11).
- In charging mode, both CO and H₂S are shown as optional sensors (fig. 45).

6.3 Suitable environment

Device inspection and adjustment must be performed in an environment with clean air. This means that the ambient air must be free of hydrocarbons and toxic gases.

During device inspection and adjustment the device will indicate whether the ambient air is clean (for instance: **Use clean air!**).

6.4 Device inspection

Device inspections are carried out to ensure the functionality of the device.

The probes and probe hoses used with the device must also be visually inspected for each device inspection (/3/).

Note:

In addition to the device inspection, the response time must be measured and documented regularly.

6.4.1 Ways of carrying out the procedure

The following options are available for carrying out the device inspection:

- free
- guided

Alternatively, the device inspection can be performed using the test set **ATS 503/501**.

Free device inspection

The user performs the device inspection on his own initiative and responsibility. The user protocols the results (e.g. on paper).

Guided device inspection

The **PM 580/550/500/400** device leads the user interactively through all the necessary tests. The tests must be selected manually.

The results can be saved in the device and read out on a computer using the **GasCom** software.

The device reminds the user in good time when the device inspection is due.

To perform a guided device inspection, it must be activated using the **GasCom** software (**Device > Edit settings > Register General II**).

Note:

These operating instructions describe only the guided device inspection.

The visual inspection of probes and probe hoses is not explicitly part of the guided device inspection. This visual inspection must therefore also be performed.

6.4.2 Frequency and due date

Frequency

The frequency of device inspections depends on the application and the national regulations. The German regulations require (3/, /6/, /14/):

Frequency (time interval)	Bump test ECO device inspection	Indication accuracy Standard device inspection
before each work shift	Warning	
weekly		Structure
quarterly		Warning Measuring



WARNING! Risk to life from using miscalibrated or faulty devices

For the Structure application, the functional safety test¹ applies only under the following conditions:

- Perform the device inspection **Warning ECO** or **Warning** daily before each work shift.
 - Also carry out the **Structure** device inspection on a weekly basis.
-

Due date

Device inspections are marked as due when the specified intervals² have been exceeded.

When switching on, the device draws attention to any device inspections that are due (fig. 10). The symbol appears in the status area in measuring mode (fig. 40).

¹ Type-examination certificate issued by DEKRA Testing and Certification GmbH

² Setting using the **GasCom** software.



  	0 CH4 %LEL	0.04 CO2 %VOL
	0.0 H2S PPM	20.9 O2 %VOL
	0 CO PPM	

Fig. 40: Measuring mode
 The **Device inspection due** symbol is displayed in the status area.

Measurement of the response time

The response time must be measured quarterly.

6.4.3 Variants of the guided device inspection (standard and ECO)

The guided device inspection can be performed in two variants. The variants differ in whether the indication accuracy is tested and whether a bump test is performed.

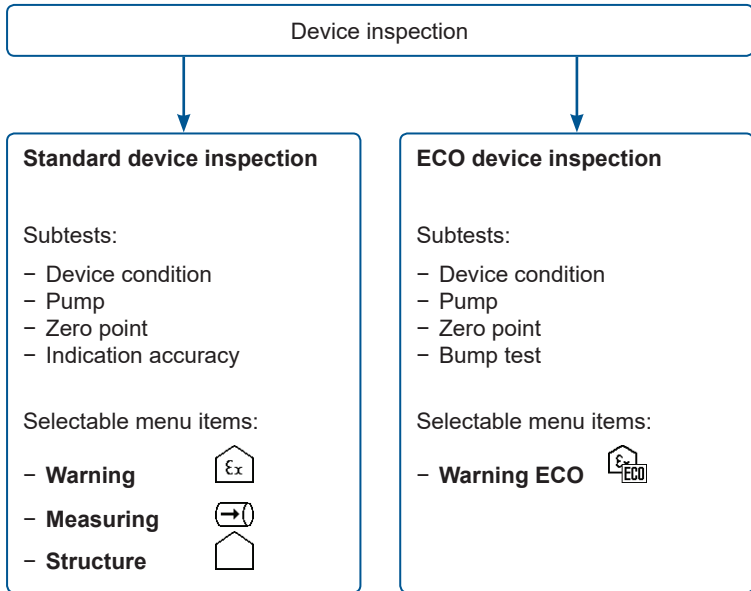

Fig. 41: Variants of device inspection with associated subtests and menu items

The **ECO** device inspection is only available in the **Warning** application.

6.4.4 Features

- The device inspection must be performed separately for each application.
- Device inspections can be saved.
- The device automatically remembers successful subtests for use in subsequent device inspections. The requirements for this are:
 - The device inspection was performed on the same day.
 - The device inspection has been saved.

Subtests

The following subtests are part of a device inspection:

- **Device condition**

Evaluation of the device external condition (visual inspection).

Test whether the signals work.

- **Pump**

Test whether the device detects a pump error. To do this, the gas input is blocked.

- **Zero point**

Check whether the zero point is within the permitted tolerances. Test gas is supplied for this purpose.

- **Indication accuracy** (for standard device inspection)

Check whether the indication accuracy lies within the permissible tolerances. Test gas is supplied for this purpose.

- **Bump test** (for **ECO** device inspection)

Check whether the display is working and whether alarms are triggered. Test gas is supplied for this purpose.

6.4.5 Presentation of results

The results of subtests and the overall results of a device inspection are displayed using the following symbols:

- ✓ Device inspection passed
- ✓ Acceptance of a passed subtest
- ✗ Device inspection failed







	Zero point	✓		ExTox IR	✗
	CH4 0.00 %VOL	✓		CH4 2.20 %VOL	✓
	CO 0 PPM	✓		CO 40 PPM	✓
	O2 20.9 %VOL	✓		O2 0.00 %VOL	✓
	H2S 0 PPM	✓		H2S 25 PPM	✗
	CO2 0.04 %VOL	✓		CO2 2.00 %VOL	✓

Fig. 42: Device inspection - overview of results

(*here*: Device inspection with ExTox IR)

Left image: Zero point

Right image: Indication accuracy (*here*: H₂S failed and the device inspection as a whole failed.)

6.4.6 Required accessories

The following accessories are required for testing the indication accuracy or the bump test:

- Test gas

Information about the utilisable test gases can be found in section 6.2.

- Test set **SPE AutoFlow**

6.4.7 Perform a device inspection

6.4.7.1 Requirements (summary)

The following requirements must be met for a device inspection:

- The device is switched on in clean air.
- The device continues to draw in clean air after it is switched on.
- The sensors are warmed up.
- The necessary accessories are available.
- The intended test gas is suitable for the gas to be tested.
- The intended test gas corresponds to the set concentrations.³

³ Setting using the **GasCom** software.

6.4.7.2 Start device inspection

The device is in measuring mode.

1. Press the Menu key.
2. Select **Device inspection**.
3. Select an application and thus also the variant of the device inspection (**Warning ECO**, **Warning, Measuring** or **Structure**).
4. Perform the tests described below (section 6.4.7.3 to section 6.4.7.6).

6.4.7.3 Checking the device condition

An application is selected for the device inspection.

1. Select **Device condition**.
2. A series of questions appears. Answer them.
 - a) **Device condition: Display inverted?**
Does the display show all pixels in reverse colour assignment⁴?
 - b) **Device condition: Light and buzzer switched on?**
Is the audible signal audible and the visual signal visible?
 - c) **Device condition: Housing ok?**
Is the housing free from external damage?

The device condition check is now complete. The device switches back one menu level.

⁴ White pixels are displayed black, black pixels are displayed white.

6.4.7.4 Testing the pump

An application is selected for the device inspection.

1. Select **Pump**.
2. If the following message appears: **Disable gas input!**
 - Seal off the gas inlet, e.g. using a finger.
3. If the following message appears: **Release gas input!**
 - Release the gas input again.

The test of the pump is now complete. The device switches back one menu level.

6.4.7.5 Testing the zero point

An application is selected for the device inspection.

1. Select **Zero point**.

The following message appears: **Use clean air!**
2. Wait while the following message is visible:
Use clean air! Process ongoing ...
3. When the zero point test is complete, the result will appear.
The device switches back one menu level.

6.4.7.6 Testing the indication accuracy (standard device inspection)

The **Warning**, **Measuring** or **Structure** application is selected for the device inspection.

1. Select **Indication accuracy**.
2. Select a test gas from the list.
3. If the following message appears: **Add test gas!**
 - Add the test gas.

To do so, connect the test gas hose of the **SPE AutoFlow** to the gas input of the device.

4. Wait while the following message is visible:
Add more test gas! Process ongoing ...

5. If the following message appears: **Stop test gas!**
 - Disconnect the test gas hose from the gas inlet.
6. When the indication accuracy test is complete, an overview of the gases tested will appear.

The device returns to the test gas selection.
7. If necessary:
 - Repeat the indication accuracy test for other gases.
8. Press the Menu key. The device switches back one menu level.

6.4.7.7 Performing a bump test (ECO device inspection)

The **Warning ECO** application is selected for the device inspection.

1. Select **Bump test**.
2. Select a test gas from the list.
3. If the following message appears: **Add test gas!**
 - Add the test gas.

To do so, connect the test gas hose of the **SPE AutoFlow** to the gas input of the device.
4. Wait while the following message is visible:
Add more test gas! Process ongoing ...
5. If the following message appears: **Stop test gas!**
 - Disconnect the test gas hose from the gas inlet.
6. When the bump test is complete, an overview of the tested gases will appear.

The device returns to the test gas selection.
7. If necessary:
 - Repeat the bump test for other gases.
8. Press the Menu key. The device switches back one menu level.

6.4.7.8 Saving the device inspection

Fully performed device inspections as well as subtests can be saved in the device.

The entire device inspection or subtests were performed for a selected application.

1. Select **Save**. The device inspection is saved.
 2. If users have been created for the device:⁵
 - Select a user from the list.
 3. If necessary:
 - Enter the PIN code of the user.
- The device inspection is saved.

6.4.8 Measuring response time

The response time must be measured manually on a quarterly basis. Test gas is supplied for this purpose.

Requirement

- The device is correctly adjusted.

The device is in measuring mode.

1. Add test gas
2. Measure the time t_R until the measurement value shows 90% of the test gas concentration.

The device is in good working order if $t_R \leq (1.2 \times t_{90})$

6.5 Adjustment

The sensors and the corresponding gases are set by means of adjustment. To this end, the zero point is adjusted successively and then the sensitivity to the reference values.

⁵ Using the **GasCom** software.

6.5.1 Frequency

It is mandatory to perform an adjustment in the following cases:

- Measurement values outside the specified limit values (section 9.6)
- Device inspection failed

Only the affected gases need to be adjusted, not the entire device.

6.5.2 Features

Note:

Only specialist technicians may perform adjustments.

- The adjustment of a gas must be performed separately for each application.
 - The ambient air is used to perform adjustment of the zero point.
Exception:
A test gas must be used for oxygen. The test gas must not contain oxygen.
 - Test gases must be used to perform adjustment of the sensitivity.
Exception:
The ambient air is used for oxygen. (Fresh air contains 20.9% vol. oxygen.)
- The device will automatically apply adjusted gases for other applications or test gases. The requirement for this is:
 - The adjustment was performed on the same day.
- Failed adjustments are saved in the error list.

6.5.3 Presentation of results

The result of an adjustment is displayed with the following symbols:

- ✓ Adjustment successful
- ✓ Acceptance of a successful adjustment
- ✗ Adjustment failed

























	Zero point	
	CH4 0.00 %VOL	
	CO 0 PPM	
	O2 20.9 %VOL	
	H2S 0 PPM	
	CO2 0.00 %VOL	
	ExTox IR	
	CH4 2.20 %VOL	
	CO 14 PPM	
	O2 0.0 %VOL	
	H2S 40 PPM	
	CO2 2.00 %VOL	

Fig. 43: Adjustment – overview of results

Left image: Zero point

Right image: Gases (*here*: ExTox IR, CO adjustment failed)

6.5.4 Required accessories

The following accessories are required for an adjustment:

- Test gas

Information about the utilisable test gases can be found in section 6.2.1.

- Test set **SPE AutoFlow**

Alternatively, the adjustment can be performed using the test set **ATS**.

- CO2 filter (carbon dioxide filter)

Only devices with a CO₂ sensor: To perform adjustment of the **Warning** application.

- Conditioner

To perform adjustment of the **Structure** application.

6.5.5 Performing an adjustment



WARNING! Risk to life due to incorrect adjustment

The incorrectly adjusted devices may fail to warn users in time of dangerous gas concentrations.

- Perform the adjustment only in well ventilated rooms or in the open air.
-

Note:

When performing adjustment, the user is supported by the display of situation-dependent information and manual requests.

6.5.5.1 Requirements (summary)

The following requirements must be met for an adjustment:

- The user is an authorised person.
- The device is switched on in clean air.
- The device continues to draw in clean air after it is switched on.
- The sensors are warmed up.
- The necessary accessories are available.
- The intended test gas is suitable for the gas to be adjusted.
- The intended test gas corresponds to the set concentrations⁶.

⁶ Setting using the **GasCom** software.

6.5.5.2 Warning application

The device is in measuring mode.

1. Press the Menu key.
2. Select **Settings**. The PIN prompt appears.
3. Enter the PIN code.
4. Select **Adjustment**.
5. Select **Warning**.
6. Select a suitable test gas.
7. Press the Enter key. Adjustment of the zero point begins.
8. If the following message appears:
Supply clean air via CO2 filter!
 - Connect the CO2 filter to the gas input.
9. Wait while the following message is visible:
Use clean air! Process ongoing ...
10. When the zero point adjustment is complete, an overview will appear (fig. 43, left image).
The adjustment will continue automatically.
11. If the following message appears: **Add test gas!**
 - a) Remove the carbon dioxide filter from the gas inlet.
 - b) Add the test gas provided.
To do so, connect the test gas hose of the **SPE AutoFlow** to the gas input of the device.
12. Wait while the following message is visible:
Add more test gas! Process ongoing ...
13. If the following message appears: **Stop test gas!**
 - Disconnect the test gas hose from the gas inlet.
14. When the adjustment is complete, an overview of the adjusted gases will appear (fig. 43, right image).
The device returns to the test gas selection.
15. If necessary:
 - Repeat the adjustment for further gases.

6.5.5.3 Measuring application

The device is in measuring mode.

1. Press the Menu key.
2. Select **Settings**. The PIN prompt appears.
3. Enter the PIN code.
4. Select **Adjustment**.
5. Select **Measuring**.
6. Select a suitable test gas.
7. Press the Enter key. Adjustment of the zero point begins.

The following message appears: **Use clean air!**

8. Wait while the following message is visible:
Use clean air! Process ongoing ...
9. When the zero point adjustment is complete, an overview will appear (fig. 43, left image).

The adjustment will continue automatically.

10. If the following message appears: **Add test gas!**

- Add the test gas provided.

To do so, connect the test gas hose of the **SPE AutoFlow** to the gas input of the device.

11. Wait while the following message is visible:

Add more test gas! Process ongoing ...

12. If the following message appears: **Stop test gas!**

- Disconnect the test gas hose from the gas inlet.

13. When the adjustment is complete, an overview of the adjusted gases will appear (fig. 43, right image).

The device returns to the test gas selection.

14. If necessary:

- Repeat the adjustment for further gases.

6.5.5.4 Structure application

The device is in measuring mode.

1. Press the Menu key.
2. Select **Settings**. The PIN prompt appears.
3. Enter the PIN code.
4. Select **Adjustment**.
5. Select **Structure**.
6. Select a suitable test gas.
7. Press the Enter key. Adjustment of the zero point begins.
8. If the following message appears:
Supply clean air via conditioner!
 - Connect the conditioner to the gas input.
9. Wait while the following message is visible:
Use clean air! Process ongoing ...
10. When the zero point adjustment is complete, an overview will appear (fig. 43, left image).
11. The adjustment will continue automatically. If the following message appears: **Add test gas via conditioner!**
 - Add the test gas provided.
To do this, connect the test gas hose of the **SPE AutoFlow** to the conditioner.
12. Wait while the following message is visible:
Add more test gas! Process ongoing ...
13. If the following message appears: **Stop test gas!**
 - a) Remove the test gas hose from the conditioner.
 - b) Remove the conditioner from the gas input.
14. When the adjustment is complete, an overview of the adjusted gases will appear (fig. 43, right image).
The device returns to the test gas selection.
15. If necessary:
 - Repeat the adjustment for further gases.

6.6 Servicing

Note:

Servicing may be performed only by competent persons.

The device must be serviced once a year.

- Send the device to SEWERIN Service for servicing.
- If there is a service contract, the device can be serviced by the mobile service.

An inspection sticker on the device confirms the last servicing and shows the next due date.



Fig. 44: Inspection sticker

7 Power supply

7.1 Overview

The device can be operated using:

- Disposable batteries (not rechargeable)
- Rechargeable batteries (rechargeable)

The device requires three disposable or rechargeable batteries inserted into a battery holder. Only approved disposable or rechargeable batteries may be used. The device is supplied with nickel metal hydride rechargeable batteries.

The following can be used as an alternative to individual rechargeable batteries in the battery holder:

- Battery pack (rechargeable)

When the battery pack is used the battery holder is not required.

Whether the device is fitted with a battery holder or with a battery pack can be distinguished by the external colour.

- Battery holder: orange
- Battery pack: black



WARNING! Risk of explosion due to leaking disposable or rechargeable batteries

Leaking electrolyte can reduce the creepage distance and air gaps between the poles. This may mean that the batteries no longer meet the required standards.

- Replace leaking batteries immediately.
 - Clean the battery compartment (and if necessary the device) before inserting the new disposable/rechargeable batteries.
-

7.2 Approved disposable batteries and rechargeable batteries



WARNING! Risk of explosion due to unsuitable batteries

To ensure that the device remains explosion-proof only certain disposable/rechargeable batteries may be used (/19/).

- At the same time, always use power sources that are identical in terms of type, capacity, state (new or used) and manufacturer.
- Use disposable/rechargeable batteries other than those supplied by SEWERIN only if they comply with the specifications below.

Disposable batteries and rechargeable batteries

When using the following rechargeable batteries, explosion protection is ensured and the functional safety test applies:

	Disposable battery	Rechargeable battery
Designation:	–	– FDK HR3UWX – Fujitsu HR-3UTHC – GP 270AAHC – Panasonic BK-3HCDE

When using the following battery types, explosion protection is ensured without the functional safety test applying:

	Disposable battery	Rechargeable battery
Type:	Alkaline	NiMH
Format, size:	Mignon AA LR6 (/11/)	Mignon AA HR6 (/13/)
Capacity:		2,000 – 2,500 mAh
Creepage distance and air gap between the poles (/8/):	≥ 0.5 mm	≥ 0.5 mm
Other requirements:		<ul style="list-style-type: none"> – quick charging ($I > 0.5 \text{ A}$) – suitable up to the upper limit of the operating temperature (40°C)

Battery pack

Only the original SEWERIN battery pack is approved for use with the device.

7.3 Rechargeable batteries

7.3.1 Charging mode

Devices powered by rechargeable batteries¹ can be charged using accessories. When being charged, the device is in charging mode.

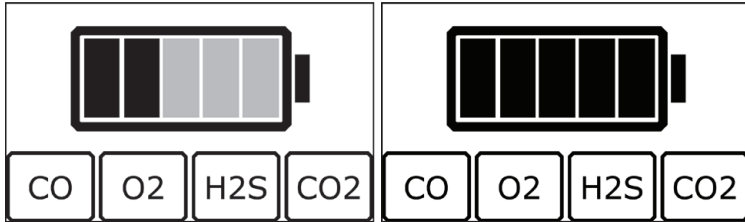

Fig. 45: Charging mode
at the bottom edge: Display of the optional sensors of the device
Left image: Battery is being charged
The black segments flash.
Right image: Battery is fully charged (charge maintenance)
The black segments do not flash.

Charging mode is characterised by intelligent charging management. The device detects the current charge level of the rechargeable batteries and responds to this, for example:

- Once the rechargeable batteries are fully charged, the device switches to charge maintenance.
- The device recharges regularly for the purpose of charge maintenance.
- If the maximum battery temperature is exceeded, charging is interrupted until the temperature drops again.

Note:

When an attempt is made to charge a device powered by batteries, the display shows the **Battery** symbol.

¹ Battery pack or individual rechargeable batteries in the battery holder.

7.3.1.1 Required accessories

The following accessories are required to charge the rechargeable batteries:

- Docking station **PM 5** or **PM 5-T**

OR

- Test set **ATS**

To connect the accessory to a power source you need:

- AC/DC adapter **M4**

OR

- Vehicle cable **M4** (charging in a vehicle)



DANGER! Risk of explosion from sparks

High charging currents occur when batteries are being charged.

- Only ever charge the device outside of explosive areas.
-

7.3.1.2 Charging the batteries

Note:

Observe the specified charging temperatures.

- At temperatures outside the specified charging temperatures, it may not be possible to charge the batteries.
 - Temperatures from 10 to 25°C (50 to 77 °F) are ideal for charging.
-

The device is switched off or on.

1. Insert the device into the docking station or test set.
2. Connect the docking station or test set to a power source using a power cable. The device switches to charging mode.

7.3.2 Rechargeable battery servicing

The actual daily operating time of the device depends on the battery capacity. Rechargeable batteries lose charge even when the device is not in use.

SEWERIN recommends: Charge the device regularly when not in use.

7.4 Alarm at undervoltage

If the remaining capacity of the disposable/rechargeable batteries falls below a certain level, then the device will issue two levels of warnings.

1st level

Message: **Batteries almost exhausted**

Warnings: visual:
– the **Remaining capacity** symbol flashes
audible:
– signal is emitted (simultaneously)
– operating signal doubles

Remaining
operating time: approx. 15 min

2nd level

Message: **Battery exhausted**

Warnings: visual:
– no display except the **Remaining capacity** symbol
audible:
– a continuous signal is emitted

Remaining
operating time: none (the device switches itself off)

7.5 Changing the disposable/rechargeable batteries



DANGER! Risk of explosion from sparks

The device is not explosion proof when the housing is open.

- Only ever open the battery compartment outside of explosive areas.
-

Note:

If a battery pack is used, the entire battery holder is replaced.

The battery compartment is on the underside of the device. To open the battery compartment, you will need a hexagon key wrench (size 2.5).

1. Loosen the screw securing the battery compartment.
2. Pull out the battery holder.
3. Change the disposable/rechargeable batteries. Ensure that the batteries are inserted with the correct polarity.
4. Replace the battery holder and tighten the screw.
5. The battery type must be set correctly when the device is next switched on. The options are:
 - **Disposable battery** (alkaline)
 - **Rechargeable battery** (NiMH)

If it takes longer than 120 seconds to change the rechargeable/rechargeable batteries, the date and time will have to be reset.

8 Faults and problems

8.1 Error messages

If a fault occurs during operation, an error message will appear on the display. Error messages are displayed in the order in which they occur. Up to 5 errors can be displayed.

The update rate for error messages is max. 1 second. Error messages continue to be displayed until the error is corrected.

Error messages with error code F7 – F59

Error code	Errors	Corrective action
F7	Sensor not adjusted: EC	Adjust device!
F8	Sensor not adjusted: PX	Adjust device!
F9	Sensor not adjusted: IR	Adjust device!
F10	Adjustment error.	Check test gas! Otherwise sensor faulty.*
F11	Zero point not OK.	Adjust device!
F52	Memory error: XFlash	Contact SEWERIN Service!**
F59	Voltage error.	Contact SEWERIN Service!

* Check that the test gas selected in the device corresponds to the test gas actually used. If the test gas is correct, a faulty sensor may have caused the error message. In that case contact SEWERIN Service.

** First try to fix the error by **restoring** the device (section 4.3.3).

Error messages with error code F60 – F64

Error code	Errors	Corrective action
F60	Sensor error: PX/CC	Contact SEWERIN Service!
F61	Sensor error: PX/TC	Contact SEWERIN Service!
F62	Sensor error: IR	Contact SEWERIN Service!
F63	Sensor error: PX	Contact SEWERIN Service!
F64	Sensor error: PX/SC.	Contact SEWERIN Service!

Error messages with error code F80 – F200

Error code	Errors	Corrective action
F80	Sensor error: Air pressure	Contact SEWERIN Service!
F81	Sensor error: Moisture	Contact SEWERIN Service!
F90	Battery voltage too low.	Check/replace battery!
F91	Battery voltage too high.	Check/replace battery!
F100	Pump error.	Check suction path!*
F200	System error: I2C slave	Contact SEWERIN Service!

* Check all filters, probes and hose connections for porosity and dirt.

8.2 Warning messages

Warnings include information for the user that refers to the operation of the device or device itself.

Warning	Corrective action
Battery almost flat.	Change or charge batteries.
Battery flat.	1. Where applicable: leave the danger area. 2. Change or charge batteries.
Incorrect PIN.	Enter PIN code again and correctly.
Zero point not set.	1. Where applicable: leave the danger area. 2. For corrective action see section 8.3.2.

8.3 Resolution of problems

8.3.1 Device has sucked water in

When using probes in particular, the device may accidentally draw in water. If the user does not notice this immediately, an error message (**Pump error**) will appear after some time.

The device is designed so that any water that is sucked in is collected in the filter opening. Care must be taken when removing the water to ensure no water enters the inside of the device.

NOTICE!

Please observe the following instructions to prevent damage to the device:

- Remove the water as soon as possible.
 - Please note all the information about changing the filter in section 3.11.
 - Follow the sequence of operations described below.
 - Replace both the old damp filters with new, dry filters.
 - Dry the probe before re-use.
-

The device is switched off.

1. When a probe is connected:
 - Remove the probe from the gas inlet.
2. Turn the filter fastener anticlockwise until it reaches the stop.
3. Pull off the filter fastener.
4. Tip the water out of the filter opening.
5. Thoroughly dry the filter opening with an absorbent cloth, lint-free if possible. Alternatively, you can also use a cleansing tissue or paper tissue.
6. Remove the O-ring and hydrophobic filter from the filter opening.
7. Carefully dry the filter opening once again.
8. Remove the dust filter from the filter fastener.
9. Dry the filter fastener.
10. Insert a new dust filter into the filter fastener. Press the filter in gently.
11. Carefully insert a new hydrophobic filter into the filter opening.
12. Replace the O-ring.
13. Replace the filter fastener. Make sure the side lugs are correctly oriented.
14. Turn the filter fastener clockwise until it reaches the stop.

8.3.2 Temporary zero point cannot be set

If the zero point cannot be set, the device emits a visual and an audible signal and one of the following messages appears:

- **Start sensors ...**

Cause The sensors are not yet sufficiently warmed up.

Corrective action 1. Wait until the sensors have warmed up.
 2. Then try again to set the zero point.

- **Zero point not set**

Cause The ambient air is not clean.

Corrective action ● Move the device into an environment with clean air.

Cause A sensor is out of adjustment.

Corrective action ● Adjust the device.

Cause A sensor is defective.

Corrective action ● Contact SEWERIN Service.

9 Appendix

9.1 Technical data

Device data

Dimensions (W × D × H)	<ul style="list-style-type: none"> • 93 × 47 × 165 mm (3.7 × 1.9 × 6.5 inches) • 93 × 65 × 165 mm (3.7 × 2.6 × 6.5 inches) incl. belt clip
Weight	depends on the built-in sensors <ul style="list-style-type: none"> • approx. 500 g (14.2 oz) • approx. 523 g (14.8 oz) incl. belt clip
Material	housing: polycarbonate, thermoplastic polyurethane

Certificates

Certificate	explosion protection test <ul style="list-style-type: none"> • EU type-examination certificate: TÜV 17 ATEX 171969 X • IECEx: IECEx TUN 17.0027 X functional safety test <ul style="list-style-type: none"> • for: <ul style="list-style-type: none"> ◦ Warning application; gas types CH₄, C₃H₈, C₉H₂₀ (PM 400 only); gas CO₂, O₂, CO, H₂S ◦ Structure application; gas types CH₄, C₃H₈; gas CO • EU type-examination certificate/type-examination certificate: <ul style="list-style-type: none"> DEKRA Testing and Certification GmbH: <ul style="list-style-type: none"> ◦ BVS 19 ATEX G 002 X ◦ PFG 19 G 004 X
Marking	<ul style="list-style-type: none"> • I M1 Ex ia da I Ma • II2G Ex ia db eb IIC T4 Gb • II2G Ex ia db IIC T4 Gb

Features

Gas connections	Rectus NW 2.7 quick-release coupling
Display	TFT display, 380 × 224 pixels, size 56 x 33 mm
Buzzer	<ul style="list-style-type: none"> • frequency: 2.4 kHz • volume: 80 dB (A) / 30 cm
Signal light	red
Pump	diaphragm pump <ul style="list-style-type: none"> • vacuum: > 150 mbar • volume flow: > 10 l/h • pump error (F100): ≤ 5 l/h
Interface	USB 2.0 <ul style="list-style-type: none"> • docking station PM 5 or PM 5-T required
Memory	8 MB
Control	membrane keypad
Sensors	PM 580/550/500: <ul style="list-style-type: none"> • IR for flammable gases (CH₄, C₃H₈) optional: <ul style="list-style-type: none"> • IR for CO₂ • EC for O₂, CO, H₂S PM 580 plus: <ul style="list-style-type: none"> • SC for flammable gases (CH₄, C₃H₈) PM 400: <ul style="list-style-type: none"> • CC for flammable gases (CH₄, C₃H₈, C₉H₂₀, C₂H₂, H₂, JFuel) optional: <ul style="list-style-type: none"> • IR for CO₂ • EC for O₂, CO
Filter	can be changed: <ul style="list-style-type: none"> • hydrophobic filter • dust filter

Operating conditions

Operating temperature	-20 – 40°C (-4 to 104 °F)
Humidity	5 – 95% r.h., non-condensing <ul style="list-style-type: none"> • short term: 0% r.h.
Atmospheric pressure	700 – 1,200 hPa <ul style="list-style-type: none"> • pressure compensation for IR sensor
Pressure at gas inlet	max. 30 hPa (millibar)
Protection rating	IP65

Storage conditions

Storage temperature	<ul style="list-style-type: none"> • devices without an EC sensor: -25 – 60°C (-13 to 140 °F) • devices with an EC sensor: -25 – 40°C (-4 to 104 °F)
Humidity	5 – 95% r.h., non-condensing
Atmospheric pressure	700 – 1,200 hPa

Power supply

Power supply	3 cells, type Mignon AA, optionally: <ul style="list-style-type: none"> • disposable batteries: alkaline • rechargeable batteries: NiMH 2500 mAh alternatively: <ul style="list-style-type: none"> • PM 5 battery pack
Operating time, typical	at 25°C (77 °F) , depending on the product variant and application <ul style="list-style-type: none"> • PM 580/550/500, Warning application: 16 h • PM 580/550, Measuring application: 11 h • PM 580, Structure application: 8 h • PM 400, Warning application: 11 h • PM 400 with IR for CO₂, Warning application: 9 h <p>the times apply only when no alarm is triggered during operation.</p>
Battery voltage	<ul style="list-style-type: none"> • NiMH: 3 × 1.2 V • alkaline: 3 × 1.5 V
Charging time	approx. 5 h (fully charged) at 2500 mAh
Charging temperature	0 – 35°C (32 to 95 °F)
Charging voltage	12 VDC
Charging current	max. 300 mA
Charger	<ul style="list-style-type: none"> • AC/DC adapter M4 • vehicle cable M4

Data transmission

Communication	USB 2.0
---------------	---------

Gas types

Default	CH ₄
Optional	PM 580/550/500: C ₃ H ₈ PM 400: C ₃ H ₈ , C ₉ H ₂₀ , C ₂ H ₂ , H ₂ , JFuel

9.2 Sensors

Note:

When using probes, the specified response times are extended.

9.2.1 Infrared sensors

Methane CH₄, propane C₃H₈ (Warning application)

Type	infrared sensor (IR)
Use	PM 580/550/500
Measuring range	0 – 100% LEL <ul style="list-style-type: none"> • CH₄: 0 – 4.40% vol. (adjustable 4.00 – 5.00% vol.) • C₃H₈: 0 – 1.70% vol. (adjustable 1.50 – 2.10% vol.)
Resolution	<ul style="list-style-type: none"> • CH₄: 1% LEL or 0.05% vol. • C₃H₈: 1% LEL or 0.02% vol.
Response times	<ul style="list-style-type: none"> • CH₄: t₅₀ < 13 s t₉₀ < 25 s • C₃H₈: t₅₀ < 15 s t₉₀ < 28 s
Warm-up time	< 120 s
Temperature range	-20 – 40°C (-4 to 104 °F)
Measuring error	according to EN 60079-29-1 <ul style="list-style-type: none"> • CH₄: ±1% LEL (short-term stability) ±4% LEL (long-term stability) • C₃H₈: ±1% LEL (short-term stability) ±2% UEG (long-term stability)
Interference	all hydrocarbons
Humidity	5 – 95% r.h., non-condensing <ul style="list-style-type: none"> • short term: 0% r.h.
Lifetime	24 months (60 months expected)
Test gases	<ul style="list-style-type: none"> • zero point: clean air • CH₄: 2.20% vol. • C₃H₈: 1.00% vol.
Humidity gas/test gas	5 – 95% r.h., non-condensing <ul style="list-style-type: none"> • short term: 0% r.h. • error: ±9% of the EMR
Pressure	700 – 1,200 hPa <ul style="list-style-type: none"> • error: ±2% of the EMR

Methane CH₄, propane C₃H₈ (Measuring application)

Type	infrared sensor (IR)
Use	PM 580/550
Measuring range	0 – 100% vol.
Resolution	<ul style="list-style-type: none"> • 0.0 – 9.9% vol.: 0.1% vol. • 10 – 100% vol.: 1% vol.
Response times	<ul style="list-style-type: none"> • CH₄: t₅₀ < 13 s t₉₀ < 23 s • C₃H₈: t₅₀ < 15 s t₉₀ < 28 s
Warm-up time	< 120 s
Temperature range	-20 – 40°C (-4 to 104 °F)
Measuring error	<ul style="list-style-type: none"> • CH₄: <ul style="list-style-type: none"> ◦ to 4.4% vol.: ±10% of measured value (linearity), at least ±0.2% vol. ◦ 4.4% vol. – 9.9% vol.: ±10% of measured value (linearity), at least ±0.5% vol. ◦ 10% vol. – 100% vol.: ±3% of measured value (linearity), at least ±2% vol. • C₃H₈ <ul style="list-style-type: none"> ◦ to 1.7% vol.: ±10% of measured value (linearity), at least ±0.2% vol. ◦ 1.7% vol. – 100% vol.: ±5% of measured value (linearity), at least ±0.5% vol.
Interference	all hydrocarbons
Humidity	5 – 95% r.h., non-condensing <ul style="list-style-type: none"> • short term: 0% r.h.
Lifetime	24 months (60 months expected)
Test gases	<ul style="list-style-type: none"> • zero point: clean air • CH₄: 100% vol. • C₃H₈: 100% vol. <p>setting ranges:</p> <ul style="list-style-type: none"> • CH₄: 50 – 100% vol. • C₃H₈: 50 – 100% vol.

Methane CH₄ (Structure application)

Type	infrared sensor (IR)
Use	PM 580
Measuring range	0 – 100% vol.
Resolution	<ul style="list-style-type: none"> • 0.00 – 4.40% vol.: 0.05% vol. • 4.5 – 9.9% vol.: 0.1% vol. • 10 – 100% vol.: 1% vol.
Response times	t ₅₀ < 13 s t ₉₀ < 23 s
Warm-up time	< 120 s
Temperature range	-20 – 40°C (-4 to 104 °F)
Measuring error	±3% of measured value (linearity)
Interference	all hydrocarbons
Humidity	5 – 95% r.h., non-condensing <ul style="list-style-type: none"> • short term: 0% r.h.
Lifetime	24 months (60 months expected)
Test gases	<ul style="list-style-type: none"> • zero point: clean air • CH₄: 100% vol. setting ranges: <ul style="list-style-type: none"> • CH₄: 50 – 100% vol.

Propane C₃H₈ (Structure application)

Type	infrared sensor (IR)
Use	PM 580
Measuring range	0 – 1.70% vol.
Resolution	0.02% vol.
Response times	t ₅₀ < 15 s t ₉₀ < 28 s
Warm-up time	< 120 s
Temperature range	-20 – 40°C (-4 to 104 °F)
Measuring error	±5% of measured value (linearity)
Interference	all hydrocarbons
Humidity	5 – 95% r.h., non-condensing <ul style="list-style-type: none"> • short term: 0% r.h.
Lifetime	24 months (60 months expected)
Test gases	<ul style="list-style-type: none"> • zero point: clean air • C₃H₈: 1.00% vol.

Carbon dioxide CO₂ (Warning application)

Type	infrared sensor (IR)
Use	PM 580/550/500/400
Measuring range	0 – 5.00% vol.
Indication range	-0.50 – 5.00% vol.
Resolution	0.02% vol.
Response times	$t_{50} \leq 15$ s $t_{90} \leq 30$ s
Decay times	$t_{10} \leq 23$ s $t_{50} \leq 13$ s
Warm-up time	< 120 s
Stabilisation time	≤ 80 s
Temperature range	-20 – 40°C (-4 to 104 °F)
Measuring error	<ul style="list-style-type: none"> • ±3% of measured value (linearity), at least ±0.04% vol. • ±0.04% vol. (long-term stability) as per EN 45544
Drift	≤ 0.05% vol. per month
Zero point deviation	0.04% vol.
Interference	none
Humidity	5 – 95% r.h., non-condensing <ul style="list-style-type: none"> • short term: 0% r.h. • error: ≤ 5% of measured value, at least ±0.04% vol.
Lifetime	24 months (60 months expected)
Test gases	<ul style="list-style-type: none"> • zero point: clean air <ul style="list-style-type: none"> ◦ use a CO₂ filter! • sensitivity: 2.00% vol. CO₂ setting ranges: <ul style="list-style-type: none"> • CO₂: 1.00 – 2.50% vol. humidity: short-term 0% r.h.
Pressure	700 – 1,200 hPa <ul style="list-style-type: none"> • error: ≤ 5% of measured value, at least ±0.04% vol.

9.2.2 Semiconductor sensor

Methane CH₄, propane C₃H₈ (Structure application)

Type	gas-sensitive semiconductor (SC)
Use	PM 580
Measuring range	<ul style="list-style-type: none"> • CH₄: 0 – 4000 ppm for LEL 4.40% vol. • C₃H₈: 0 – 1500 ppm for LEL 1.70% vol.
Resolution	1/2/20/200 ppm
Response times	<ul style="list-style-type: none"> • CH₄: 100 ppm: $t_{50} < 7$ s $t_{90} < 10$ s 1,000 ppm: $t_{50} < 5$ s $t_{90} < 8$ s • C₃H₈: 3,000 ppm: $t_{50} < 8$ s $t_{90} < 11$ s <p>when using the SPE AutoFlow: the response times can be extended by up to 4 s as additional volume must be passed through (test gas hose, conditioner).</p>
Warm-up time	< 120 s
Temperature range	-20 – 40°C (-4 to 104 °F)
Measuring error	for measurement values > 100 ppm under the same ambient conditions: <ul style="list-style-type: none"> • CH₄: ±20% of measured value (linearity) • C₃H₈: ±20% of measured value (linearity)
Interference	<ul style="list-style-type: none"> • all hydrocarbons • H₂ • water vapour
Lifetime	12 months (60 months expected)
Test gases	<p>use the conditioner for all test gases!</p> <ul style="list-style-type: none"> • zero point: clean air • CH₄: 1,000 ppm in synth. air • C₃H₈: 0.3 ppm in synth. air <p>setting ranges:</p> <ul style="list-style-type: none"> • CH₄: 100 – 1000 ppm • C₃H₈: 100 – 3000 ppm

9.2.3 Catalytic combustion sensor

Methane CH₄, propane C₃H₈, nonane C₉H₂₀, acetylene C₂H₂, hydrogen H₂, JFuel (kerosine)

Type	catalytic combustion sensor (CC)	
Use	PM 400	
Measuring range	0 – 100% LEL • CH ₄ : 0 – 4.40% vol. (adjustable 4.00 – 5.00% vol.) • C ₃ H ₈ : 0 – 1.70% vol. (adjustable 1.50 – 2.10% vol.) • C ₉ H ₂₀ : 0 – 0.70% vol. • C ₂ H ₂ : 0 – 2.30% vol. • H ₂ : 0 – 4.00% vol. • JFuel: 0 – 0.70% vol.	
Resolution	• CH ₄ : 1% LEL or 0.05% vol. • C ₃ H ₈ : 1% LEL or 0.02% vol. • C ₉ H ₂₀ : 2% LEL or 0.02% vol. • C ₂ H ₂ : 2% LEL or 0.05% vol. • H ₂ : 1% LEL or 0.05% vol. • JFuel: 2% LEL or 0.02% vol.	
Response times	• CH ₄ : t ₅₀ < 7 s t ₉₀ < 13 s • C ₃ H ₈ : t ₅₀ < 7 s t ₉₀ < 13 s • C ₉ H ₂₀ : t ₅₀ < 23 s t ₉₀ < 3 min • C ₂ H ₂ : t ₅₀ < 6 s t ₉₀ < 10 s • H ₂ : t ₅₀ < 6 s t ₉₀ < 11 s • JFuel: t ₅₀ < 15 s t ₉₀ < 60 s	
Warm-up time	< 120 s	
Temperature range	-20 – 40°C (-4 to 104 °F)	
Measuring error	according to EN 60079-29-1 • CH ₄ : ±1% LEL (short-term stability) ±4% LEL (long-term stability) • C ₃ H ₈ : ±2% LEL (short-term stability) ±2% LEL (long-term stability) • C ₉ H ₂₀ : ±2% LEL (short-term stability) ±8% LEL (long-term stability) • C ₂ H ₂ : ±1% LEL (short-term stability) ±4% LEL (long-term stability) • H ₂ : ±1% LEL (short-term stability) ±2% LEL (long-term stability) • JFuel: ±2% LEL (short-term stability) ±8% LEL (long-term stability) when using a substitute test gas: • C ₉ H ₂₀ : ±30% of the measured value • JFuel: ±30% of the measured value	

Interference	all flammable gases
Humidity	5 – 95% r.h., non-condensing • short term: 0% r.h.
Lifetime	24 months (60 months expected)
Test gases	<ul style="list-style-type: none"> • zero point: clean air • CH₄: 2.20% vol. in synth. air • C₃H₈: 1.00% vol. in synth. air • C₉H₂₀: 0.22% vol. in synth. air (substitute test gas 0.30% vol. C₃H₈ in synth. air) • C₂H₂: 1.00% vol. in synth. air • H₂: 2.00% vol. in synth. air • JFuel: 0.32% vol. in synth. air (substitute test gas 0.30% vol. C₃H₈ in synth. air) <p>setting ranges:</p> <ul style="list-style-type: none"> • CH₄: 1.00 – 3.50% vol. • C₃H₈: 0.50 – 1.30% vol. • C₉H₂₀: 0.20 – 0.50% vol. • C₂H₂: 0.50 – 1.80% vol. • H₂: 1.00 – 3.20% vol. • JFuel: 0.20 – 0.50% vol.
Humidity gas/test gas	5 – 95% r.h., non-condensing • short term: 0% r.h. • error: ±5 % of the EMR
Pressure	700 – 1,200 hPa error: <ul style="list-style-type: none"> • CH₄: 800 – 1200 hPa ±3% of the EMR 700 – 1200 hPa ±4% of the EMR • C₃H₈: 800 – 1200 hPa ±2% of the EMR 700 – 1200 hPa ±2% of the EMR

9.2.4 Electrochemical sensors

Note:

At temperatures below 0°C (3 °F) the specified response times and decay times may be longer.

Oxygen O₂

Type	electrochemical sensor (EC)
Use	PM 580/550/500/400
Measuring range	0 – 25.0% vol.
Indication range	-3 – 25.0% vol.
Resolution	0.1% vol.
Response times	t ₂₀ < 10 s t ₉₀ < 32 s
Warm-up time	< 2 min
Stabilisation time	< 90 s
Temperature range	-20 – 40°C (-4 to 104 °F)
Drift	≤ 3% within 3 months
Interference	none
Humidity	5 – 95% r.h., non-condensing • short term: 0% r.h.
Lifetime	24 months (60 months expected)
Test gases	• zero point: clean air • O ₂ : 0.0% vol. setting ranges: • O ₂ : 0.0 – 1.0% vol.
Humidity gas/test gas	5 – 95% r.h., non-condensing • short term: 0% r.h. • error: ±3% of the EMR
Pressure	700 – 1,200 hPa • error: ±3% of the EMR

Carbon monoxide CO

Type	electrochemical sensor (EC)
Use	PM 580/550/500/400
Measuring range	0 – 300 ppm
Indication range	-30 – 300 ppm
Resolution	1 ppm
Response times	$t_{50} \leq 12$ s $t_{90} \leq 26$ s
Decay times	$t_{10} \leq 27$ s $t_{50} \leq 14$ s
Warm-up time	2 min
Stabilisation time	≤ 2 min
Temperature range	-20 – 40°C (-4 to 104 °F)
Measuring error	<ul style="list-style-type: none"> • $\pm 3\%$ of measured value (linearity), at least ± 3 ppm (± 3 digits) • ± 5 ppm (long-term stability) as per EN 45544
Drift	< 10% within 6 months
Zero point deviation	± 3 ppm
Interference	at 20°C (68 °F) <ul style="list-style-type: none"> • 400 ppm H₂: < 70 ppm • 20 ppm H₂S: < 0.1 ppm • 100 ppm C₂H₂: < 200 ppm • 400 ppm C₂H₄: < 100 ppm • 100 ppm NO: < 50 ppm
Humidity	5 – 95% r.h., non-condensing <ul style="list-style-type: none"> • short term: 0% r.h. • error: $\leq 5\%$ of measured value, at least ± 3 ppm (± 3 digits)
Lifetime	24 months (36 months expected)
Test gases	<ul style="list-style-type: none"> • zero point: clean air • sensitivity: 40 ppm CO setting ranges: <ul style="list-style-type: none"> • CO: 10 – 50 ppm humidity: short-term 0% r.h.
Pressure	700 – 1,200 hPa <ul style="list-style-type: none"> • error: $\leq 6\%$ of measured value, at least ± 3 ppm (± 3 digits)

Hydrogen sulphide H₂S

Type	electrochemical sensor (EC)
Use	PM 580/550/500
Measuring range	0 – 50.0 ppm
Indication range	-10 – 100 ppm
Resolution	0.5 ppm
Response times	$t_{50} \leq 12$ s $t_{90} \leq 29$ s
Decay times	$t_{10} \leq 28$ s $t_{50} \leq 14$ s
Warm-up time	< 120 s
Stabilisation time	≤ 2 min
Temperature range	-20 – 40°C (-4 to 104 °F)
Measuring error	<ul style="list-style-type: none"> • ±3% of measured value (linearity), at least ±3 ppm (±6 digits) • ±2 ppm (long-term stability) as per EN 45544
Drift	≤ 15% within 6 months
Zero point deviation	±2 ppm
Interference	at 25°C (77 °F) <ul style="list-style-type: none"> • 400 ppm H₂: < 1 ppm H₂S • 400 ppm CO: < 1.5 ppm H₂S • 100 ppm C₂H₂: < 2 ppm H₂S • 400 ppm C₂H₄: < 0.1 ppm H₂S • 50 ppm NO: < 12 ppm H₂S • 10 ppm NO₂: < -25 ppm H₂S
Humidity	5 – 95% r.h., non-condensing <ul style="list-style-type: none"> • short term: 0% r.h. • error: ≤ 5% of measured value, at least ±2 ppm (±4 digits)
Lifetime	24 months (36 months expected)
Test gases	<ul style="list-style-type: none"> • zero point: clean air • sensitivity: 40 ppm H₂S setting ranges: <ul style="list-style-type: none"> • H₂S: 10.0 – 50.0 ppm humidity: short-term 0% r.h.
Pressure	700 – 1,200 hPa <ul style="list-style-type: none"> • error: ≤ 4% of measured value, at least ±2 ppm (±4 digits)

COSH: carbon monoxide CO and hydrogen sulphide H₂S

Type	electrochemical sensor (EC)
Use	PM 580/550/500
Measuring range	<ul style="list-style-type: none"> • CO: 0 – 300 ppm • H₂S: 0 – 50.0 ppm
Indication range	<ul style="list-style-type: none"> • CO: -30 – 300 ppm • H₂S: -10 – 100 ppm
Resolution	<ul style="list-style-type: none"> • CO: 1 ppm • H₂S: 0.5 ppm
Response times	<ul style="list-style-type: none"> • CO: $t_{50} \leq 11$ s $t_{90} \leq 28$ s • H₂S: $t_{50} \leq 11$ s $t_{90} \leq 27$ s
Decay times	<ul style="list-style-type: none"> • CO: $t_{10} \leq 28$ s $t_{50} \leq 14$ s • H₂S: $t_{10} \leq 27$ s $t_{50} \leq 13$ s
Warm-up time	< 120 s
Stabilisation time	≤ 2 min
Temperature range	-20 – 40°C (-4 to 104 °F)
Measuring error	<ul style="list-style-type: none"> • ±3% of measured value (linearity), at least ±6 ppm (±6 digits) • ±5 ppm (long-term stability) as per EN 45544
Drift	≤ 10% within 6 months
Zero point deviation	<ul style="list-style-type: none"> • CO: ±2 ppm • H₂S: ±2 ppm
Interference	<p>at 20°C (68 °F)</p> <ul style="list-style-type: none"> • 400 ppm H₂: < 55 ppm CO, < 1 ppm H₂S • 400 ppm CO: < 2 ppm H₂S • 40 ppm H₂: ≤ 4 ppm CO • 100 ppm C₂H₂: < 200 ppm CO, < 2 ppm H₂S • 50 ppm NO: < 50 ppm CO, < 10 ppm H₂S
Humidity	<p>5 – 95% r.h., non-condensing</p> <ul style="list-style-type: none"> • short term: 0% r.h. • error: <ul style="list-style-type: none"> ◦ CO: ≤ 5% of measured value, at least ±7 ppm (±7 digits) ◦ H₂S: ≤ 5% of measured value, at least ±2 ppm (±4 digits)
Lifetime	24 months (36 months expected)
Test gases	<ul style="list-style-type: none"> • zero point: clean air • sensitivity: 40 ppm CO 40 ppm H₂S <p>setting ranges:</p> <ul style="list-style-type: none"> • CO: 10 – 50 ppm • H₂S: 10.0 – 50.0 ppm <p>humidity: short-term 0% r.h.</p>

Pressure	700 – 1,200 hPa error: <ul style="list-style-type: none"> ◦ CO: ≤ 5% of measured value, at least ±3 ppm (±3 digits) ◦ H₂S: ≤ 5% of measured value, at least ±2 ppm (±4 digits)
----------	---

9.2.5 Measuring ranges in the applications (overview)

PM 580

Sensor	Gas/ gas type	Warning	Measuring	Structure
IR	CH ₄	0 – 100% LEL	0 – 100% vol.	0 – 4.40% vol.*
	C ₃ H ₈	0 – 100% LEL	0 – 100% vol.	0 – 1.70% vol.**
	CO ₂	0 – 5.00% vol.	–	–
SC	CH ₄ C ₃ H ₈	–	–	0 – 4500 ppm
EC	CO	0 – 300 ppm	–	0 – 300 ppm
	O ₂	0 – 25.0% vol.	0 – 25.0% vol.	–
	H ₂ S	0 – 50.0 ppm	–	–

* Display up to 100% vol.

** Condition at delivery. Other settings possible (section 9.5).

PM 550

Sensor	Gas/ gas type	Warning	Measuring	Structure
IR	CH ₄ C ₃ H ₈	0 – 100% LEL	0 – 100% vol.	–
	CO ₂	0 – 5.00% vol.	–	–
EC	CO	0 – 300 ppm	–	–
	O ₂	0 – 25.0% vol.	0 – 25.0% vol.	–
	H ₂ S	0 – 50.0 ppm	–	–

PM 500

Sensor	Gas/ gas type	Warning	Measuring	Structure
IR	CH ₄ C ₃ H ₈	0 – 100% LEL	–	–
	CO ₂	0 – 5.00% vol.	–	–
EC	CO	0 – 300 ppm	–	–
	O ₂	0 – 25.0% vol.	–	–
	H ₂ S	0 – 50.0 ppm	–	–

PM 400

Sensor	Gas/ gas type	Warning	Measuring	Structure
IR	CO ₂	0 – 5.00% vol.	–	–
CC	CH ₄ C ₃ H ₈ C ₉ H ₂₀ C ₂ H ₂ H ₂ JFuel	0 – 100% LEL	–	–
EC	CO	0 – 300 ppm	–	–
	O ₂	0 – 25.0% vol.	–	–

9.3 Test gases

9.3.1 Preset test gases

PM 580

Test gas	Gas									
	CH ₄	C ₃ H ₈	C ₉ H ₂₀	CO ₂	O ₂	CO	H ₂ S	C ₂ H ₂	H ₂	JFuel
CH ₄ 100% vol.	x				x					
CH ₄ 1,000 ppm	x									
C ₃ H ₈ 100% vol.		x								
C ₃ H ₈ 0.30% vol.		x								
ExTox IR*	x			x	x	x	x			
ExCOx IR	x			x	x	x				

* Devices that are set up for gas type CH₄ alone show the test gas CH₄ 2.20% vol. instead of the test gas ExTox IR.
 Devices with a COSH sensor: refer to section 6.2.3!

PM 550

Test gas	Gas									
	CH ₄	C ₃ H ₈	C ₉ H ₂₀	CO ₂	O ₂	CO	H ₂ S	C ₂ H ₂	H ₂	JFuel
CH ₄ 100% vol.	x				x					
C ₃ H ₈ 100% vol.		x								
C ₃ H ₈ 0.30% vol.		x								
ExTox IR*	x			x	x	x	x			
ExCOx IR	x			x	x	x				

* Devices that are set up for gas type CH₄ alone show the test gas CH₄ 2.20% vol. instead of the test gas ExTox IR.
 Devices with a COSH sensor: refer to section 6.2.3!

PM 500

Test gas	Gas									
	CH ₄	C ₃ H ₈	C ₉ H ₂₀	CO ₂	O ₂	CO	H ₂ S	C ₂ H ₂	H ₂	JFuel
C ₃ H ₈ 0.30% vol.		x								
ExTox IR*	x			x	x	x	x			
ExCOx IR	x			x	x	x				

* Devices that are set up for gas type CH₄ alone show the test gas CH₄ 2.20% vol. instead of the test gas ExTox IR.
Devices with a COSH sensor: refer to section 6.2.3!

PM 400

Test gas	Gas									
	CH ₄	C ₃ H ₈	C ₉ H ₂₀	CO ₂	O ₂	CO	H ₂ S	C ₂ H ₂	H ₂	JFuel
CH ₄ 100% vol.					x					
C ₃ H ₈ 0.30% vol.		x	x							x
C ₂ H ₂ 1.00% vol.								x		
H ₂ 2.00% vol.									x	
ExTox CAT*	x			x	x	x				

* Devices that are set up for gas type CH₄ alone show the test gas CH₄ 2.20% vol. instead of the test gas ExTox CAT.

9.3.2 Setting ranges:

Note:

Test gas concentrations can be changed only by using the **GasCom** software and only for test gases set up by the user himself.

Warning application

Gas	Unit	LEL*	Min	Max	Condition at delivery	Resolution
CH ₄	% vol.	4.40	1.00	3.50	2.20	0.01
C ₃ H ₈	% vol.	1.70	0.5	1.30	0.30	0.01
C ₉ H ₂₀ **	% vol.	0.70	0.20	0.50	0.21	0.01
C ₂ H ₂	% vol.	2.30	0.50	1.80	1.00	0.01
H ₂	% vol.	4.00	1.00	3.20	2.00	0.01
JFuel***	% vol.	0.70	0.20	0.50	0.32	0.01

* Condition at delivery. Other settings possible (section 9.5).

Substitute test gas:

** 0.21% vol. C₉H₂₀ is equivalent to 0.3% vol. C₃H₈

*** 0.32% vol. JFuel is equivalent to 0.3% vol. C₃H₈

Gas	Unit	EMR	Min	Max	Condition at delivery	Resolution
CO ₂	% vol.	5.00	1.00	2.50	2.00	0.01
O ₂	% vol.	25.0	0.0	1.0	0.0	0.1
CO	ppm	300	10	50	40	1
H ₂ S	ppm	100	10.0	50.0	40.0	0.1

Measuring application

Gas	Unit	EMR	Min	Max	Condition at delivery	Resolution
CH ₄	% vol.	100	50	100	100	1
C ₃ H ₈	% vol.	100	50	100	100	1

Structure application

Gas	Unit		Min	Max	Condition at delivery	Resolution
CH ₄	ppm		100	1,000	1,000	10
C ₃ H ₈	ppm		100	3,000	3,000	10

9.4 Alarms

Note:

Always observe the warning in section 2.3.3.4.

9.4.1 Features

The alarms are prioritised as follows:

- **AL1 < AL2 < AL3 < STEL < LTEL**
- with **AL1** lowest priority, **LTEL** highest priority

A higher priority alarm takes precedence over a lower priority alarm. If different alarms occur simultaneously, only the alarm with the highest priority is signalled.

The update rate for alarms is max. 1 second.

AL1: Pre-alarm	
Adjustable:	yes
Latching:	no exception: for oxygen, AL1 is self-latching.
Trigger:	when the alarm threshold AL1 is reached exception: in the case of oxygen, the alarm is triggered after level falls below alarm threshold AL1 .
Indicator:	<ul style="list-style-type: none">• audible signal• visual signal• AL1 symbol
Acknowledgement:	audible signal <ul style="list-style-type: none">• after the alarm has been triggered
Reset:	automatic when level falls below alarm threshold AL1

AL2: Main alarm	
Adjustable:	yes
Latching:	yes
Trigger:	when the alarm threshold AL2 is reached
Indicator:	<ul style="list-style-type: none"> • audible signal • visual signal • AL2 symbol
Acknowledgement:	audible signal <ul style="list-style-type: none"> • after the alarm has been triggered overall alarm • after the level has fallen below the alarm threshold AL2
Reset:	<ul style="list-style-type: none"> • after the level has fallen below the alarm threshold AL2 the alarm must also be acknowledged or have already been acknowledged. • by switching off the device

AL3: End of measuring range	
Adjustable:	no
Latching:	yes
Trigger:	when the alarm threshold AL3 is reached
Indicator:	<ul style="list-style-type: none"> • audible signal • visual signal • AL3 symbol
Acknowledgement:	overall alarm <ul style="list-style-type: none"> • after the level has fallen below the alarm threshold AL1 exception: on PM 400 devices the alarm can only be acknowledged for CO ₂ , O ₂ and CO, but not for flammable gases.
Reset:	<ul style="list-style-type: none"> • after the level has fallen below the alarm threshold AL1 the alarm must also be acknowledged or have already been acknowledged. • by switching off the device

STEL: Main alarm (Short Time Exposure Limit)	
Adjustable:	yes
Latching:	yes
Trigger:	the sum of the concentrations of a gas is greater than the product of the Occupational Exposure Limit and the excess factor over the averaging time
Indicator:	<ul style="list-style-type: none"> • audible signal • visual signal • STEL symbol
Acknowledgement:	not possible
Reset:	<ul style="list-style-type: none"> • by changing the application • by switching off the device

LTEL: Main alarm (Long Time Exposure Limit)	
Adjustable:	yes
Latching:	yes
Trigger:	the sum of the concentrations of a gas is greater than the Occupational Exposure Limit over the averaging time
Indicator:	<ul style="list-style-type: none"> • audible signal • visual signal • LTEL symbol
Acknowledgement:	not possible
Reset:	<ul style="list-style-type: none"> • by changing the application • by switching off the device

9.4.2 Setting ranges:

Note:

Alarms can be changed using the **GasCom** software.

- In the **GasCom** software, the flammable gases are set in % LEL and displayed in % vol.

Specifications

When setting alarms you must comply with the following specifications:

- CO₂, O₂, CO: **AL1 < AL2 ≤ AL3**
- all other gases: **AL1 < AL2 < AL3**
- flammable gases also:
 - **AL2** at least 3% LEL greater than **AL1**
 - **AL3** equals LEL

Gas	Unit	Increment	AL1	AL2	STEL	LEL
CH ₄ *	% LEL	1	5 – 57	8 – 60	–	–
C ₃ H ₈ *	% LEL	1	5 – 57	8 – 60	–	–
C ₉ H ₂₀ *	% LEL	1	5 – 57	8 – 60	–	–
CO ₂	% vol.	0.02	0.10 – 1.00	0.50 – 5.00	0.1 – 1.0	0.1 – 1.0
CO	ppm	1	5 – 30	16 – 300	10 – 100	10 – 50
H ₂ S	ppm	0.5	5 – 19	6 – 49	4 – 10	4 – 10
C ₂ H ₂ *	% LEL	1	5 – 57	8 – 60	–	–
H ₂ *	% LEL	1	5 – 57	8 – 60	–	–
JFuel*	% LEL	1	5 – 57	8 – 60	–	–

* LEL see section 9.5.

9.4.3 Alarm thresholds (condition at delivery)

Gas	Unit	AL1	AL2	AL3	STEL**	LEL**
CH ₄ *	% LEL	10	50	100	–	–
C ₃ H ₈ *	% LEL	10	50	100	–	–
C ₉ H ₂₀	% vol.	0.07	0.35	0.70	–	–
CO ₂	% vol.	0.50	2.00	5.00	1.00	0.50
O ₂	% vol.	18.0	23.0	25	–	–
CO	ppm	30	60	300	60	30
H ₂ S	ppm	5	10	50	10	5
C ₂ H ₂	% vol.	0.23	1.15	2.30	–	–
H ₂	% vol.	0.40	2.00	4.00	–	–
JFuel	% vol.	0.07	0.35	0.70	–	–

* LEL see section 9.5.

** according to /18/.

9.5 LEL

Note:

The LEL can be changed using the **GasCom** software.

- For gases with an adjustable LEL, they must always be in accordance with the legal specifications in the area of use.

Gases with adjustable LEL

Gas	Unit	Increment	LEL	Condition at delivery*
CH ₄	% vol.	0.01	4.00 – 5.00	4.40
C ₃ H ₈	% vol.	0.01	1.50 – 2.10	1.70

* according to /13/ for Europe.

Gases with non-modifiable LEL

Gas	Unit	LEL
C ₉ H ₂₀	% vol.	0.70
C ₂ H ₂	% vol.	2.30
H ₂	% vol.	4.00
JFuel	% vol.	0.70

9.6 Limit values for device inspection

Gas	Zero point		Sensitivity	
	Specification	Deviation	Specification	Deviation
CH ₄	0.00% vol.	±0.15% vol.	2.20% vol.	±0.20% vol.
C ₃ H ₈	0.00% vol.	±0.10% vol.	1.00% vol.	±0.10% vol.
C ₉ H ₂₀	0.00% vol.	±0.05% vol.	0.21% vol.	±0.04% vol.
CO ₂	0.04% vol.	±0.06% vol.	2.00% vol.	±0.20% vol.
O ₂	0% vol.	±1.0% vol.	20.9% vol.	±1.0% vol.
CO	0 ppm	±3 ppm	40 ppm	±4 ppm
H ₂ S	0 ppm	±3 ppm	40 ppm	±4 ppm
C ₂ H ₂	0.00% vol.	±0.15% vol.	1.00% vol.	±0.10% vol.
H ₂	0.00% vol.	±0.15% vol.	2.00% vol.	±0.20% vol.
JFuel	0.00% vol.	±0.05% vol.	0.32% vol.	±0.06% vol.

9.7 Type examinations

9.7.1 Explosion protection test

Ex marking	PM 580	PM 550	PM 500	PM 400	Battery holder	Battery pack
					(PM05-B0300)	(PM05-B0400)
I M1 Ex ia da l Ma				x		x
II2G Ex ia db eb IIC T4 Gb	x	x	x	x	x	
II2G Ex ia db IIC T4 Gb	x	x	x	x		x

Certificates

- EU type-examination certificate: TÜV 17 ATEX 171969 X
- IECEx: IECEx TUN 17.0027 X

The certificates can be found online.

9.7.2 Functional safety test

Scope of the examination

Applications:

- Warning
- Structure

Gas types (to /14/):

	Measuring range:
– Methane CH ₄	0 - 100% LEL (PM 580/550/500/400)
– Propane C ₃ H ₈	0 - 100% LEL (PM 580/550/500/400)
– Nonane C ₉ H ₂₀	0 - 100% LEL (PM 400)

Gases (to /7/):

	Measuring range:
– Carbon dioxide CO ₂	0 – 5.00% vol.
– Oxygen O ₂	0 – 25.0% vol.
– Carbon monoxide CO	0 – 300 ppm
– Hydrogen sulphide H ₂ S	0 – 50 ppm

Accessories (general):

- Test set SPE AutoFlow
- PM 5 short probe

Accessories for methane CH₄, propane C₃H₈, carbon dioxide CO₂, oxygen O₂, carbon monoxide CO, hydrogen sulphide H₂S:

- Flexible hand probe with probe hose HG 1 m
- Floating probe with probe hose 6 m
- Flexible probe HG5

Accessories for nonane C₉H₂₀:

- Floating probe
- Probe hose HG 1 m nonane

Rechargeable battery:

- FDK HR3UWX
- Fujitsu HR-3UTHC
- GP 270AAHC
- Panasonic BK-3HCDE

Testing institute

DEKRA Testing and Certification GmbH

Certificates

- EU type-examination certificate: BVS 19 ATEX G 002 X
- Type-examination certificate: PFG 19 G 004 X

The certificates can be found online.

Tested to:

- EN 45544-1, EN 45544-3, EN 50104, EN 50271, EN 60079-29-1

Not tested

- Functions: Storage of recordings and device inspections as well as the corresponding protocols
- Battery type: alkaline
- Test set: ATS 503/501
- Gases: Acetylene C₂H₂, hydrogen H₂, JFuel
- Software: GasCom

9.8 Device identification







Fig. 46: Label on the back of the device (here: **PM 580**)

The device is marked in accordance with the statutory regulations. The label on the back of the device contains the following information:





- Serial number
- Date of manufacture (month/year)
- Ex marking (depending on product variant)
- Certification
- Voltage, current

- Protection rating
- Manufacturer
- Notified body (CE mark)

Symbols

-  CE mark
 -  Only ever open the battery compartment outside of explosive areas.
Warning
 -  Explosion protection logos
 -  Follow the operating instructions.
 -  Do not dispose of device in domestic waste.
-

9.9 Symbols on the display

-  **Applications**
 -  Warning
 -  Measuring
 -  Structure
-

Alarms



AL1: Pre-alarm



AL2: Main alarm



AL3: End of measuring range



STEL (Short Time Exposure Limit)



LTEL (Long Time Exposure Limit)



Audible signal off

Actions/responses to questions



Confirm or Yes



Cancel or No

Actions when writing comments



Confirm (apply)



Cancel



Insert



Delete

Messages



Warning



Errors



Question



Information



Wait



Device switches off

Measuring mode



Recording



Start recording



Stop recording



Set zero point



Information about the application



Comment











Write











Remaining capacity (disposable/rechargeable battery)

Settings

-  Language
 -  PIN code
 -  Settings
 -  Adjustment
 -  Restore
 -  Date/time
 -  Date
 -  Time
 -  PPM threshold
-

Device inspection

-  Device inspection due
 -  Warning ECO
 -  Device condition
 -  Pump
 -  Zero point
 -  Indication accuracy/Bump test
 -  Save
 -  Device inspection passed
 -  Device inspection failed
-

Gas type



Gas type

Protocols



Protocols



Recordings



Device inspections



Inspector

Information



Information



Device



Errors



Test gases



Microcontroller: Firmware version



Battery type



Next servicing



Sensor: Installation date



Sensor: Lifetime

Charging mode and data exchange



Data exchange



Battery is being charged



Battery fully charged



Battery too hot



Battery too cold



Battery deeply discharged



Battery is prepared for charging



Disposable battery

9.10 Accessories and consumables

Accessories

Part	Order number
Docking station PM 5	LP12-10000
Docking station PM 5-T	LP12-20000
AC/DC adapter M4	LD10-10001
Vehicle cable M4, 12 V= portable	ZL07-10100
Vehicle cable M4 12 V = mounting	ZL07-10000
Vehicle cable M4 24 V = mobile	ZL09-10000
Flexible probe HG5	ZS44-10000
Flexible hand probe	ZS32-10000
Probe hose HG 1 m	ZZ27-10000
Probe hose HG 1 m nonane	ZZ27-10100
Probe hose 6 m	ZS18-10100
Floating probe	ZS21-10100
Case HG5 L-BOXX	ZD64-10000
Test set ATS 503	PP05-10101
Test set ATS 501	PP05-10001
Test set SPE AutoFlow	PP05-20000
Conditioner SC	PP05-Z3000
CO2 filter	ZG06-10000

Consumables

Part	Order number
Filter PM 5 dust (5 pcs.)	2498-0023
Filter PM 5 hydrophobic (10 pcs.)	2498-0021
Hydrophobic filter D28	2491-0020
Rechargeable NiMH AA mignon 2500 mAh	1354-0009
Battery Alkaline Mignon	1353-0001
Battery pack	PM05-B0400
Test gas 1,000 ppm CH ₄ *	ZT29-10001
Test gas 2.2% vol. CH ₄ *	ZT03-10001
Test gas 100% vol. CH ₄ *	ZT20-10000
Test gas 0.3% vol. C ₃ H ₈ *	ZT35-10001
Test gas 1.0% vol. C ₃ H ₈ *	ZT11-10001
Test gas 100% vol. C ₃ H ₈ **	ZT22-10001
Test gas ExTox IR*	ZT47-10000
Test gas ExTox CAT*	ZT32-10000
Test gas ExCOx IR*	ZT52-10000

* Test gas can 1 ltr, pressure approx. 12 bar

** Test gas can 1 ltr, pressure approx. 7 bar

Other accessories and consumables are available for the product. Please contact the SEWERIN sales department for further information.

Apart from the following exceptions, the same storage conditions apply to accessories and consumables as to the device.

- Test gas cans:
max. 50°C (122 °F), no exposure to sunlight
- Disposable batteries/rechargeable batteries :
max. 20°C (68 °F), max. 1 year

9.11 Care

All that is necessary to care for the device is to wipe it down with a damp cloth.

NOTICE!

Possible damage to property from unsuitable cleaning agents

Unsuitable cleaning agents can chemically corrode the housing surface. Fumes from solvents and substances containing silicone can penetrate into the device and damage the sensors.

- Never use solvents, petrol, cockpit sprays containing silicone or similar substances to clean the device.
-

9.12 Advice on disposal

The European Waste Catalogue (EWC) governs the disposal of devices and accessories in accordance with EU Directive 2014/955/EU.

Waste	EWC code
Device	16 02 13
Test gas can	16 05 05
Disposable battery, rechargeable battery	16 06 05

Alternatively, devices can be returned to Hermann Sewerin GmbH.

9.13 Legal basis

The following standards and regulations as well as European Directives form the basis for working with the device.

- /1/ BG RCI (German Social Accident Insurance Institution for the raw materials and chemical industry) Code of Practice T 021 (DGUV Information 213-056) Gas Warning Devices for Toxic Gases/Vapours and Oxygen - Use and Operation
- /2/ BG RCI (German Social Accident Insurance Institution for the raw materials and chemical industry) Code of Practice T 023 (DGUV Information 213-057) Gas Warning Devices for Explosion Protection – Use and Operation.
- /3/ DVGW G 465-4 (M) (2019)
Equipment Technology for Inspection of Gas Pipelines and Gas Systems.
- /4/ EN 45544-1
- /5/ EN 45544-3
- /6/ EN 45544-4
- /7/ EN 50104:2010
- /8/ EN 50271:2018
- /9/ EN 60079-0
- /10/ EN 60079-1
- /11/ EN 60079-7:2016
- /12/ EN 60079-11
- /13/ EN 60079-20-1:2010
- /14/ EN 60079-29-1
- /15/ EN 60079-29-2
- /16/ EN 60086-1
- /17/ EN 61951-2
- /18/ TRGS 900: 2006
Technical Regulations for Hazardous Substances: occupational exposure limit values
- /19/ 2014/34/EU (ATEX)

9.14 Declaration of conformity

Hermann Sewerin GmbH hereby declares that the **EX-TEC® PM 580/550/500/400** system fulfils the requirements of the following directives:

- 2011/65/EU
- 2014/30/EU
- 2014/34/EU

Gütersloh, 2020-12-15



Dr. S. Sewerin (General Manager)

The complete declaration of conformity can be found online.

9.15 Abbreviations

% vol.	Percentage of a gas in a gas mixture based on the volume
AL	Alarm (AL1, AL2, AL3)
CC	Catalytic combustion sensor
CENELEC	European Committee for Electrotechnical Standardization
COSH	Name of sensor which can measure CO and H ₂ S concurrently
EC	Electrochemical sensor
EMR	End of measuring range
IR	Infrared sensor
LEL	Lower Explosion Limit
LTEL	Long Time Exposure Limit
NiMH	Nickel metal hydride
ppm	parts per million
SC	Gas-sensitive semiconductor
STEL	Short Time Exposure Limit
TC	Thermal conductivity sensor

9.16 Technical terms

Acknowledgement

Error message or an alarm to be noted and requiring a response. Depending on the measurement situation, either only the audible alarm signal can be muted or in addition the visual signal and symbol can also be disabled.

Clean air

Air that is free from hydrocarbons and toxic gases.

Gas type

Gaseous hydrocarbon with the sum formula C_xH_y , e.g. methane CH_4 , propane C_3H_8 , nonane C_9H_{20} .

Inspection

Event for which the user can be reminded the device. The user decides individually which event with which the reminder is associated (e.g. handing over the device to the device inspector). An inspection that is due will be displayed on a start screen. The reminder date is set in the **GasCom** software.

Long Time Exposure Limit (LTEL)

Occupational exposure limit value over an averaging period of 8 hours.

Occupational exposure limit value

Time weighted average concentration of a substance in the air at the workplace. (Source: Wikipedia)

Recording

Contains the saved measurement values for a certain period of time.

Short Time Exposure Limit (STEL)

Product of the occupational exposure limit value and the excess factor over an averaging period of 15 minutes.

Stabilisation time

Time required by a sensor to produce no major deviations of more than $\pm 1\%$ of the measuring range across 3 consecutive readings read at intervals of 2 minutes.

User

General name for the user of the device, regardless of membership of a user group.

Warm-up time

Time taken by a sensor to become operational.

10 Index

A

- acknowledge 14
- Action
 - cancel 27
 - perform 29
- Adjustment 45, 65
 - devices with a COSH sensor 55
 - features 66
 - frequency 66
 - measuring application 70
 - presentation of results 67
 - requirements 68
 - structure application 71
 - warning application 69
- Alarm 103
 - acknowledge 14
 - AL1 103
 - AL2 104
 - AL3 104
 - end of measuring range 104
 - LTEL 105
 - main alarm 104, 105
 - pre-alarm 103
 - prioritisation 103
 - setting range 106
 - signals 13
 - STEL 105
 - undervoltage 78
- Alarm thresholds 107
- Application 8
 - changing 34
 - measurement ranges 98
- Audible signal *see* signal

B

- Battery compartment 79
- Battery pack 75
- Belt clip 15
- Bump test 60, 64

C

- Care 118
- Charging mode 76
- Competent person 5
- Concentration

- conversion 18
- selectable units 18
- Concentration-dependent signal 39, 47
- COSH sensor 55
 - detection 55

D

- Date 46
 - Device
 - information 51
 - marking 110
 - switching off 22
 - switching on 19
 - Device condition 60, 62
 - Device inspection 55
 - bump test 64
 - device condition 62
 - due date 57
 - ECO 59, 64
 - features 59
 - free 56
 - frequency 57
 - guided 56
 - indication accuracy 63
 - limits 108
 - presentation of results 60
 - protocols 49
 - pump 63
 - requirements 61
 - saving 65
 - standard device inspection 63
 - starting 62
 - subtests 60
 - variants of the guided device inspection 59
 - zero point 63
 - Device inspector 5
 - Display illumination 14
 - Disposable battery
 - approved 74
 - changing 22, 79
 - Dust filter 14
- ### E
- Error list 51
 - Error messages 80

F

- Faults 80
- Filter 14
 - changing 41
 - checking 42
 - dust filter 14
 - hydrophobic 14
 - position 41

G

- Gases, measurable 7
- Gas input 14
- Gas mixtures for adjusting devices with a COSH sensor 55
- Gas type 11
 - change temporarily 37

H

- Hydrophobic filter 14

I

- Indication accuracy 60, 63
- Information 50
 - alarm thresholds 52
 - application 52
 - device 51
 - error list 51
 - measurement ranges 52
 - test gases 52
- Information area 23
- Initial start-up 22
- Intended use 2

K

- Keys 25

L

- Leak-tightness test 40
- LEL 107
- Lists 29

M

- Maintenance
 - scope 53
 - suitable environment 55
 - test gases 53

- Measurement menu 16
- Measurement ranges 98
- Measuring mode 16
- Memory 48
- Menu 16
- Menu structure 17
- Messages 24

N

- Navigating 23

O

- Operating signal 13

P

- Paused measurement 12
- PIN code 28, 45
- Power supply 73
- PPM threshold 47
- Probe
 - additional 16
 - check the leak-tightness 40
 - short probe 15
- Product variants 6
- Protocols 48
 - of device inspections 49
 - of recordings 49
- Pump 60, 63
- Purpose 2

R

- Rear of the device 110
- Rechargeable battery
 - approved 74
 - changing 22, 79
 - charging 77
 - charging mode 76
 - servicing 78
- Recording
 - protocols 49
 - starting 32
 - stopping 32, 33
 - with comment 33
 - without comment 32
- Response time 65
- Restore 46

S

- Scrolling 27
- Selecting menu item 27
- Select value 28
- Sensors 9
 - external influences 10
 - operating principles 10
- Servicing 72
- Setting range 106
 - LEL 107
 - test gases 101
- Settings
 - by software 44
 - device-GasCom data exchange 44
 - on the device 38, 45
 - PIN code 45
- Short probe 15
- Signal 11
 - concentration-dependent 39
 - in the event of a fault 14
 - in the event of an alarm 13
 - operating signal 13
 - switch off audible signal 39
 - switch on audible signal 39
 - when measurement is paused 12
- Specialist 5
- Standard device inspection 59
- Start images 21
- Status area 23
- Symbols
 - display 111
 - rear of the device 111

T

- Temporarily set the
 - zero point 83
- Test gases 53
 - available 52, 54
 - preset 54, 100
 - self-set 54
 - setting range 101
 - utilisable 53
- Time 46
- Trained person 5

U

- Units 18

V

- Visual signal *see* signal

W

- Warning messages 81
- Water in the device 81
- Write comment 30

Z

- Zero point 60, 63
 - desired values 35
 - temporarily set 35



Hermann Sewerin GmbH

Robert-Bosch-Straße 3
33334 Gütersloh, Germany
Tel.: +49 5241 934-0
Fax: +49 5241 934-444
www.sewerin.com
info@sewerin.com

SEWERIN IBERIA S.L.

Centro de Negocios Eisenhower
Avenida Sur del Aeropuerto
de Barajas 28, Planta 2
28042 Madrid, España
Tel.: +34 91 74807-57
Fax: +34 91 74807-58
www.sewerin.com
info@sewerin.es

Sewerin Sp. z o.o.

ul. Twórcza 79L/1
03-289 Warszawa, Polska
Tel.: +48 22 675 09 69
Tel. kom.: +48 501 879 444
www.sewerin.com
info@sewerin.pl

SEWERIN SARL

17, rue Ampère – BP 211
67727 Hoerdts Cedex, France
Tél. : +33 3 88 68 15 15
Fax : +33 3 88 68 11 77
www.sewerin.fr
sewerin@sewerin.fr

Sewerin Portugal, Lda

Rua Sr. Dos Milagres, 16, 2º Esq
3800-261 Aveiro, Portugal
Tlf.: +351 234 133 740
Fax.: +351 234 024 446
www.sewerin.com
info@sewerin.pt

Sewerin Ltd.

Hertfordshire
UK
Phone: +44 1462-634363
www.sewerin.co.uk
info@sewerin.co.uk