

**MiniLec® 4**

# Operating Instructions



  
**SEWERIN**  
Technologies for leak detection.

## **Measurable success by Sewerin equipment**

---

Congratulations. You have chosen a quality instrument manufactured by Hermann Sewerin GmbH.

Our equipment will provide you with the highest standards of performance, safety and efficiency. They correspond with the national and international guide-lines.

Please read and understand the following operating instructions before using the equipment; they will help you to use the instrument quickly and competently. If you have any queries we are available to offer advice and assistance at any time.

Yours

### **Hermann Sewerin GmbH**

Robert-Bosch-Straße 3  
33334 Gütersloh, Germany  
Tel.: +49 5241 934-0  
Fax: +49 5241 934-444  
[www.sewerin.com](http://www.sewerin.com)  
[info@sewerin.com](mailto:info@sewerin.com)

### **SEWERIN SARL**

17, rue Ampère – BP 211  
67727 HOERDT CEDEX, France  
Tél. : +33 3 88 68 15 15  
Fax : +33 3 88 68 11 77  
[www.sewerin.fr](http://www.sewerin.fr)  
[sewerin@sewerin.fr](mailto:sewerin@sewerin.fr)

### **SEWERIN IBERIA S.L.**

Centro de Negocios "Eisenhower"  
Avenida Sur del Aeropuerto  
de Barajas 28, Of. 2.1 y 2.2  
28042 Madrid, España  
Tel.: +34 91 74807-57  
Fax: +34 91 74807-58  
[www.sewerin.es](http://www.sewerin.es)  
[info@sewerin.es](mailto:info@sewerin.es)

### **Sewerin Ltd**

Hertfordshire  
UK  
Phone: +44 1462-634363  
[www.sewerin.co.uk](http://www.sewerin.co.uk)  
[info@sewerin.co.uk](mailto:info@sewerin.co.uk)

### **Sewerin Sp.z o.o.**

ul. Twórcza 79L/1  
03-289 Warszawa, Polska  
Tel.: +48 22 675 09 69  
Tel. kom. +48 501 879 444  
[www.sewerin.pl](http://www.sewerin.pl)  
[info@sewerin.pl](mailto:info@sewerin.pl)

**Illustration MiniLec 4 with full equipment (version HP)**

---

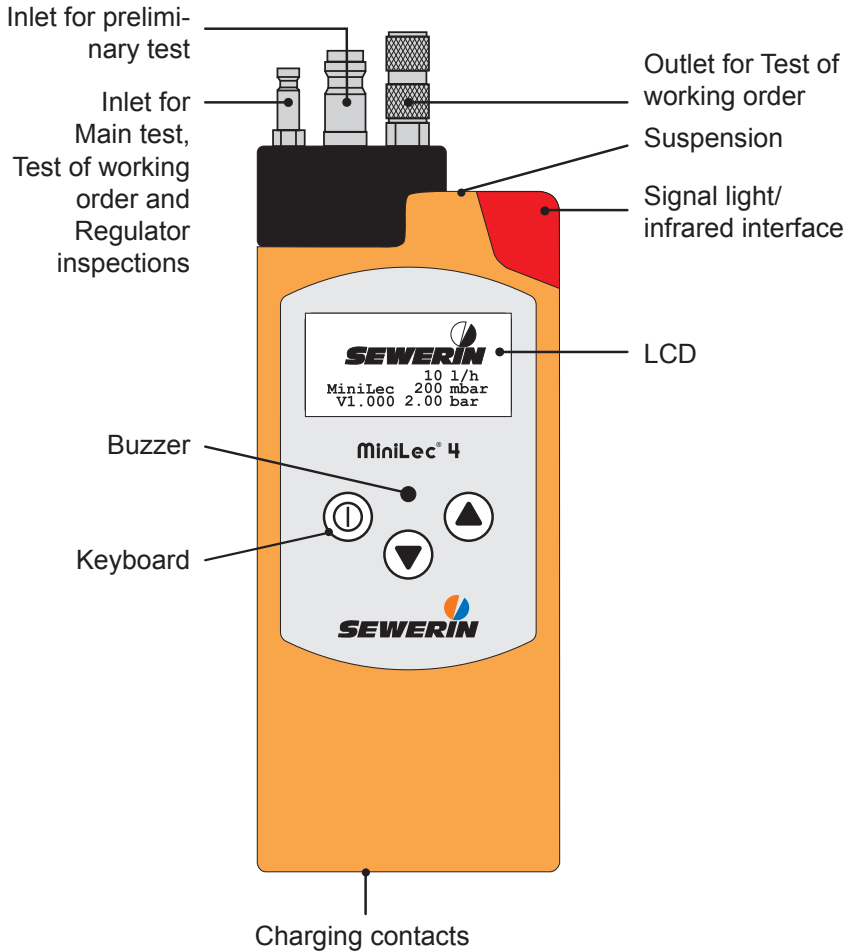

### Operating keys



Switching the instrument on/off  
(keep pressed for approx. 3 seconds)  
Entries/confirming a selection (short pressing)



Changing between the operating menus  
Selection of menu items

### LCD

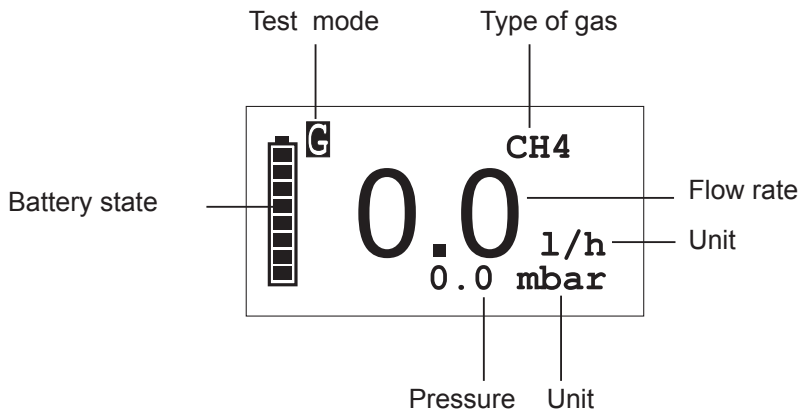

**Operating Instructions**

# **MiniLec<sup>®</sup> 4**

26.10.2016 – V3.XXX – 103999 – en

---



**CAUTION! Danger of injuries!**

This symbol refers to important safety instructions. Adhere strictly to these instructions to avoid injuries!



**CAUTION!**

This symbol refers to important safety instructions. Adhere strictly to these instructions to avoid material damages!



**Note:**

This symbol refers to information and useful tips which are exceeding the basic operating procedures.

---

<b>1</b>	<b>General information .....</b>	<b>1</b>
1.1	Warranty .....	1
1.2	Application purpose .....	2
1.3	Intended usage .....	2
1.4	General safety instructions .....	3
<b>2</b>	<b>Equipment.....</b>	<b>4</b>
2.1	Connections .....	4
2.2	Visual and audible signals.....	5
2.3	Infrared interface .....	6
<b>3</b>	<b>Operation .....</b>	<b>7</b>
3.1	Measuring mode .....	7
3.1.1	General information regarding the measuring mode.....	7
3.1.1.1	Switching on the device .....	7
3.1.1.2	User menu.....	10
3.1.2	Setting the zero point .....	11
3.1.3	Test of working order .....	12
3.1.3.1	Preparations.....	12
3.1.3.2	Execution .....	13
3.1.3.3	Analysis of working order .....	14
3.1.4	Main test.....	15
3.1.4.1	Preparations.....	15
3.1.4.2	Execution .....	16
3.1.5	Preliminary test .....	17
3.1.5.1	Preparations:.....	18
3.1.5.2	Execution .....	18
3.1.6	Regulator inspection .....	20
3.1.6.1	Preparations.....	20
3.1.6.2	Execution .....	20
3.1.6.3	Dynamic pressure .....	22
3.1.6.4	Static pressure .....	22
3.1.6.5	Reaction pressure inspection.....	23
3.1.6.6	Zero shut-off.....	23
3.1.6.7	Low-pressure cut-off valve (Low flow safe).....	23
3.1.7	Start measurement/Stop measurement/Store.....	24
3.1.8	Protocols .....	25

---

---

3.2	Extended settings .....	27
3.2.1	Access.....	27
3.2.2	Procedure.....	29
3.2.3	Info menu .....	31
3.2.3.1	Adjustment menu .....	31
3.2.3.2	System menu .....	32
3.2.3.3	Hardware menu.....	33
3.2.3.4	Parameters menu.....	35
3.2.3.5	Memory menu .....	35
<b>4</b>	<b>Charging and battery operation.....</b>	<b>36</b>
4.1	Operation with rechargeable nickel metal hydride accumulators (NiMH) .....	36
4.2	Operation with non-rechargeable alkaline batteries.....	39
<b>5</b>	<b>Maintenance .....</b>	<b>40</b>
5.1	Functional test/inspection.....	40
5.2	Check to ensure the indication accuracy and leak-tightness of the device .....	40
5.3	Adjustment .....	41
5.4	Maintenance and repair .....	41
<b>6</b>	<b>Errors .....</b>	<b>42</b>
<b>7</b>	<b>Appendix.....</b>	<b>43</b>
7.1	Equipment and permissible ranges of use .....	43
7.2	Sensors .....	44
7.3	Connection and application options .....	45
7.4	Entering a user name .....	50
7.5	Delivery variants and accessories.....	52
7.5.1	Delivery variants.....	52
7.5.2	Accessories.....	53
7.6	Declaration of conformity .....	58
7.7	Advice on disposal .....	59
7.8	Terminology and abbreviations .....	60
<b>8</b>	<b>Index.....</b>	<b>61</b>

---



# 1 General information

## 1.1 Warranty

To ensure proper functioning and safety, it is required to observe the following notes.

Hermann Sewerin GmbH is not liable for damage caused by failure to comply with these notes. The guarantee and liability conditions of the sales and delivery conditions of Hermann Sewerin GmbH are not extended by the following notes.

- This product may only be taken into operation after reading thoroughly the accompanying operating instructions.
- This product may only be taken into operation by sufficiently qualified staff who is familiar with the legal requirements (in Germany: TRGI).
- This product may only be used as set forth in these operating instructions.
- This product is exclusively destined for industrial and commercial applications.
- Repairs may only be performed by qualified experts or appropriately trained staff.
- Modifications and conversions may only be carried out with prior written consent of Hermann Sewerin GmbH. The manufacturer is not liable for damage resulting from arbitrary modifications of the product.
- Only accessories manufactured by Hermann Sewerin GmbH may be used in conjunction with the product.
- Only spare parts which are approved by Hermann Sewerin GmbH may be used for repairs.
- Only approved or recommended battery types may be used.
- Technical changes within the scope of further development reserved.

Apart from the notes and instructions included in these operating instructions, adhere also strictly to all generally valid safety and accident prevention rules!

### 1.2 Application purpose

MiniLec 4 is an electronic instrument for measuring the pressure and the flow rate of low-pressure gas installations.

Apart from performing measurements, the instrument also permits to store and record measurement data.



**Note:**

These operating instructions describe the functionalities of firmware version 2.XXX.

Subject to changes!

The descriptions always refer to the default settings of the instrument.

### 1.3 Intended usage

The instrument can be used for the following purposes:

- Serviceability determinations (i. e. tests of working order) according to DVGW worksheets G 600 (TRGI 2008) and G 624 [DGWV: German Technical and Scientific Association for Gas and Water].
- Main tests according to DVGW worksheets G 600 (TRGI 2008) and G 624.
- Preliminary tests according to DVGW worksheets G 600 (TRGI 2008) and G 624.
- Regulator inspections according to DVGW worksheets G 459-2 and G 495.

## 1.4 General safety instructions

- The **MiniLec 4** instrument is constructed in accordance with the European Ex protection standards CENELEC and ATEX 100a.
- The instrument may only be used with the following gasses:
  - Air
  - Natural gas
  - Methane (CH<sub>4</sub>)
  - Propane (C<sub>3</sub>H<sub>8</sub>)
  - Butane (C<sub>4</sub>H<sub>10</sub>)
  - Town gas (TGas)
  - Hydrogen (H<sub>2</sub>)

**Note:**

The instrument is prepared ex works for detecting methane (CH<sub>4</sub>) as test gas. Measurements with air or natural gas are also carried out with this setting. It is not required to change the type of gas.

- It is required to use supply tubes with hydrophobic filters to protect the flow rate sensor (applies to Test of working order [i. e. serviceability determinations] and Main test).
- The maximum operating pressure must not be exceeded:
  - Test mode Test of working order: max. 200 mbar
  - Test mode Main test: max. 200 mbar
  - Test mode Preliminary test: max. 2 bar
  - Test mode Regulator inspection max. 200 mbar
- The permissible operating temperature is -10 °C to +40 °C.
- The permissible storage temperature is -20 °C to +70 °C.
- The permissible humidity is 0% RH to 90% RH, non-condensing.
- The permissible ambient pressure is 860 hPa to 1100 hPa.

## 2 Equipment

The instrument can be delivered in two versions:

- Version HP (full equipment), suitable for Preliminary test, Main test, Test of working order (serviceability determinations) and Regulator inspection
- Version LP (basic equipment), suitable for Main test, Test of working order and Regulator inspection.

### 2.1 Connections



#### **CAUTION!**

Only members of staff who are familiar with the legal requirements (in Germany: TRGI) are permitted to connect and operate the instrument.

The instrument can be connected to the gas installation with the help of three quick-release connections (see illustration in the appendix):

- Inlet for Main test, Test of working order and Regulator inspection
- Inlet for Preliminary test (not available for the LP version)
- Outlet for Test of working order.



#### **Note:**

The quick-release connections allow only are designed in such a way that they allow only to connect tubes which are suitable for the appropriate test mode.

## 2.2 Visual and audible signals

MiniLec 4 is equipped with two signalling instruments:

- red signal light on top of the instrument
- buzzer at the front panel of the instrument.

**Note:**

These signalling instruments cannot be switched off.

Every touch of a key is confirmed by an audible signal:

- very long tone indicates an error message
- long tone switching off, menu change
- short tone switching on, confirming the selection, navigation within a menu

### 2.3 Infrared interface

The instrument is provided with an infrared interface (IrDA 1.0) which can be used to transmit the readings to a PC or other instruments (e. g. printer, pocket PC, organizer). It is located on the outer surface of the instrument, below the red signal light.

To ensure an optimum data transmission, you need to align the **MiniLec 4** instrument with the relevant interface of the PC, printer, etc.

The following illustration shows how the instruments are properly aligne:

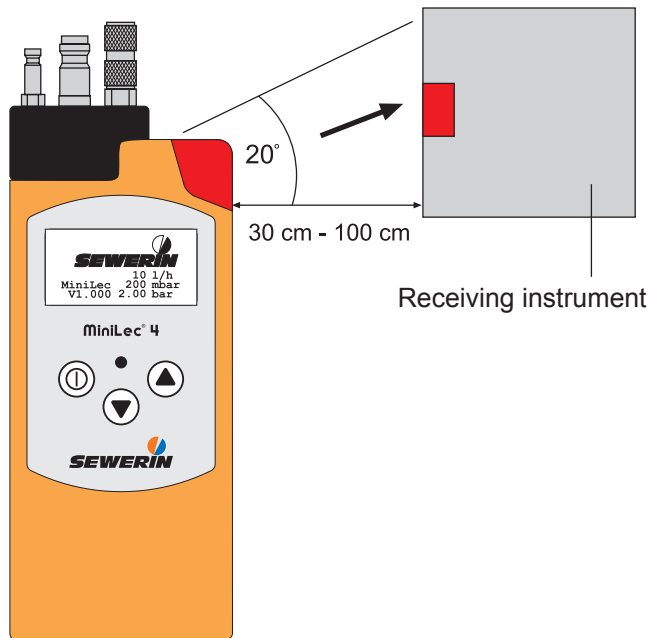

## 3 Operation

The operation of the instrument is divided into two sections:

- Measuring mode (see section 3.1)

Measurements are carried out in the measuring mode. The User menu can be used to change the test mode, to store measurement data and to call up protocols.

- Extended settings (see section 3.2)

The extended settings permit to change default measurement settings and further instrument settings (such as “Adjustment”, “System”, “Hardware”, etc.). It is not possible to carry out a measurement when the extended settings are opened.

### 3.1 Measuring mode

#### 3.1.1 General information regarding the measuring mode

##### 3.1.1.1 Switching on the device

The instrument is switched off.

- Press the  key for approx. three seconds.

The instrument is switched on. The two following start displays appear:

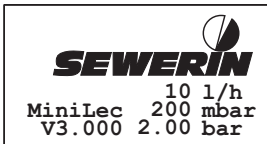

#### Start display

Indication of:

- Instrument type (MiniLec)
- Firmware version (V3.000)
- Installed sensors  
(10 l/h, 200 mbar, 2.00 bar)

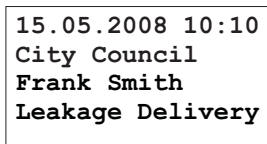

#### Date/time

Indication of:

- Date (15.05.2008)
- Time (10:10)
- User data (example)

The instrument enters the pre-set test mode.



**Note:**

The test mode to be enabled immediately after the start-up can be changed in the extended settings (see section 3.2). As default, the mode **Test of working order** is set.

The following display data depend on the testing mode.

**Test of working order**

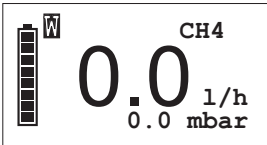
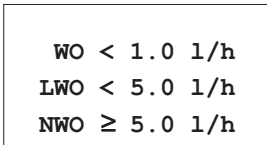
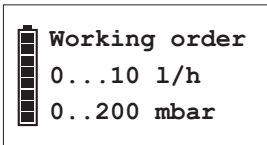

**Measuring range**

Indication of the test mode, including information on the sensors' measurement range

**Parameters**

Indication of the measuring specifications, corresponding to the selected test mode

**Measuring data**

Indication of measurement values

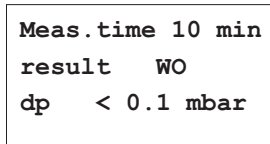
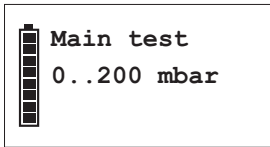
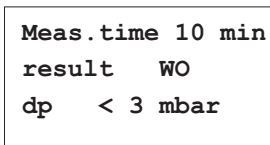
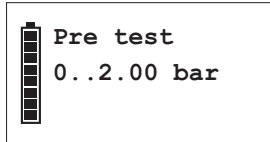

**Main test****Preliminary test****Measuring range**

Indication of the test mode, including information on the sensors' measurement range

**Parameters**

Indication of the measuring specifications, corresponding to the selected test mode

**Measuring data**

Indication of measurement values

**Measuring range**

Indication of the test mode, including information on the sensors' measurement range

**Parameters**

Indication of the measuring specifications, corresponding to the selected test mode

**Measuring data**

Indication of measurement values

While these displays are indicated, no entry is possible. If the display **Measuring data** appears, the instrument has entered the **Measuring mode**.

#### 3.1.1.2 User menu

The measuring mode permits to use the following functions:

- Zero point correction
- Selection of the test mode
- Start meas. resp. Store
- Protocols.

These functions can be called up via the **User menu**:

- Press the ▲ or ▼ key for approx. two seconds.

The **User menu** appears:

Zero point
Working order
Main test
Pre test
Regulator ins
Start meas.
Protocols
Exit

If the measurement time for the test of working order is zero, the user menu displays the menu item **Store** instead of the menu item **Start meas..**

The functions of the User menu are described in the chapters 3.1.2 to 3.1.8.

To change between the menu items:

- You can move up or down in the menu by pressing the appropriate ▲ or ▼ arrow key.
- Confirm the selection by pressing the Ⓢ key.

If the selection is not confirmed, the display returns to the measuring mode after a couple of seconds.

### 3.1.2 Setting the zero point

Before the measurements are started, the instrument can be adjusted to the ambient conditions by setting the zero point. At that time, no tubes should be attached to the instrument. If the zero point is incorrectly set, other values than zero are indicated on the display after switching on the instrument.

**Note:**

The zero point must be set for every individual test mode.

Perform the following steps to set the zero point of the instrument:

- Press the ▲ or ▼ key for approx. two seconds.
- Use the ▲ or ▼ keys to select the menu item.
- Confirm the selection with the Ⓞ key.

The instrument returns to the **Measuring mode**. The display shows **zero**.

### 3.1.3 Test of working order



#### CAUTION!

Test of working order (i. e. serviceability determinations) may only be carried out by sufficiently qualified members of staff who are familiar with the prevailing national regulations (in Germany, for example: TRGI). All relevant safety procedures and accident prevention regulations have to be taken into account.

Test of working order are carried out to determine and evaluate the operational safety of low-pressure gas installations. A built-in flow rate sensor is used to measure the amount of gas which is streaming into the gas installation over a defined period of time (leakage rate).

#### 3.1.3.1 Preparations

There are different ways to install the instrument in the supply system (see section 7.4):

- Flow measuring principle (at the location of the gas meter)
- Measuring principle of the return flow (at an arbitrary place of the pipe)
- Check of non-metered pipes
- etc.
- Switch the instrument on.
- Connect the instrument to the supply system. Use the corresponding quick-release connections for this which are installed on the instrument.
- Apply the required testing pressure.
- Check whether a **W** for the testing mode **Test of working order** is visible in the upper left section of the display. If necessary, adjust the testing mode **Working order** (see section 3.1.1.2).

## 3.1.3.2 Execution



The device is in **measuring mode**.

- Press the ▲ or ▼ key for approx. two seconds to access the User menu.
- Use the ▲ or ▼ key to select the menu item **Store** resp. **Start meas..**

**Note:**

The menu item **Start meas.** only appears if a measurement time greater than 0 minutes is specified. For tests of the working order, the measurement time is pre-set ex works to zero minutes. The menu item **Store** is indicated in the User menu instead of **Start meas..**

- Confirm with Ⓞ key.

With **Store**: The measurement is stored immediately.

With **Start meas.:**

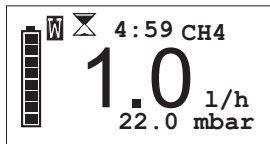

The measurement is started. The measured values and the remaining measurement time are indicated.

The end of measurement is indicated by an audible signal.

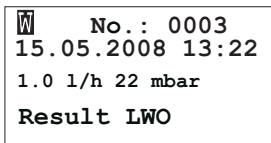

The appropriate protocol is indicated on the display for approx. 30 seconds. The measurement is stored.

- Confirm the displayed protocol with the  $\text{\textcircled{0}}$  key. The **Client/Meter no.** menu appears.
- If necessary use the  $\text{\textcircled{0}}$  key to select the menu item **Client no.**. Enter a Client no. (max. 6 digits).
- If necessary use the  $\text{\textcircled{\blacktriangle}}$  or  $\text{\textcircled{\blacktriangledown}}$  key to select the menu item **Meter no.**. Enter a Meter no. (max. 8 digits).
- Use the  $\text{\textcircled{\blacktriangle}}$  or  $\text{\textcircled{\blacktriangledown}}$  key to select the menu item **Continue**. The device will return to measuring mode.

The appropriate protocol can be called up in the User menu via the menu item **Protocols** (see section 3.1.8).

#### 3.1.3.3 Analysis of working order

Depending on the relevant country, there may be different national regulations for determining the serviceability. According to TRGI, the degree of serviceability is categorized as follows:

Leakage rate of gas  $< 1.0$  l/h

**unrestricted serviceability (result WO)**

=> Device can continue to be operated

Leakage rate of gas  $\geq 1.0$  l/h and  $< 5.0$  l/h

**reduced serviceability (result LWO)**

=> Proper working order must be established within 4 weeks

Leakage rate of gas  $\geq 5.0$  l/h

**no serviceability (result NWO)**

=> Device must be decommissioned immediately

### 3.1.4 Main test



#### CAUTION!

Main test may only be carried out by sufficiently qualified members of staff who are familiar with the prevailing national regulations (in Germany, for example: TRGI). All relevant safety procedures and accident prevention regulations have to be taken into account.

Main test are leak tests which are used to detect even the smallest leaks. For this, the pipes are checked with all fittings – but without gas equipment and corresponding controllers and safety instruments. The gas meter can be included in the test.

Depending on the relevant country, there may be different national regulations with respect to main tests. According to TRGI, the following requirements have to be met:

- The minimum test duration is 10 minutes.
- During the test, the pressure must not decrease.



#### Note:

The minimum test duration is sufficient for standard housing constructions. For installations/constructions with a larger volume, the test time may be correspondingly longer.

#### 3.1.4.1 Preparations

- Switch the instrument on.
- Connect the instrument to the supply system. Use the corresponding quick-release connection for this which is installed on the instrument.
- Apply the required testing pressure.
- Check whether an **M** for the testing mode **Main test** is visible in the upper left section of the display. If necessary, adjust the testing mode **Main test** (see section 3.1.1.2).
- Wait for the temperature equalisation.

#### 3.1.4.2 Execution



The device is in **measuring mode**.

- Press the ▲ or ▼ key for approx. two seconds to access the User menu.
- Use the ▲ or ▼ key to select the menu item **Start meas..**
- Confirm with Ⓞ key.



The measurement is started. The measured values and the remaining measurement time are indicated.

The end of measurement is indicated by an audible signal.

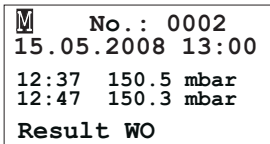

The appropriate protocol is indicated on the display for approx. 30 seconds. The measurement is stored.

- Confirm the displayed protocol with the Ⓞ key. The **Client/Meter no.** menu appears.
- If necessary use the ▲ or ▼ key to select the menu item **Client no.**. Enter a Client no. (max. 6 digits).
- If necessary use the ▲ or ▼ key to select the menu item **Meter no.**. Enter a Meter no. (max. 8 digits).
- Use the ▲ or ▼ key to select the menu item **Continue**. The device will return to measuring mode.

The appropriate protocol can be called up in the User menu via the menu item **Protocols** (see section 3.1.8).



### 3.1.5 Preliminary test

**CAUTION!**

Preliminary test may only be carried out by sufficiently qualified members of staff who are familiar with the prevailing national regulations (in Germany, for example: TRGI). All relevant safety procedures and accident prevention regulations have to be taken into account.

Preliminary test are used to test the endurance of the relevant material. Newly installed pipes are checked without fittings.

**Note:**

Fittings whose nominal pressure stage is at least equal to the testing pressure, may be subjected to Preliminary test.

Depending on the relevant country, there may be different national regulations with respect to Preliminary test. According to TRGI, the following requirements have to be met:

- The minimum test duration is 10 minutes.
- During the test, the pressure must not decrease.

**Note:**

The minimum test duration is sufficient for standard housing constructions. For installations/constructions with a larger volume, the test time may be correspondingly longer.

#### 3.1.5.1 Preparations:

- Switch the instrument on.
- Connect the instrument to the supply system. Use the corresponding quick-release connection for this which is installed on the instrument.
- Apply the required testing pressure.
- Check whether an **P** for the testing mode **Preliminary test** is visible in the upper left section of the display. If necessary, adjust the testing mode **Pre test** (see section 3.1.1.2).
- Wait for the temperature equalisation.

#### 3.1.5.2 Execution

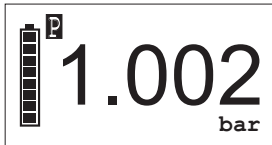

The device is in **measuring mode**.

- Press the ▲ or ▼ key for approx. two seconds to access the User menu.
- Use the ▲ or ▼ key to select the menu item **Start meas..**
- Confirm with Ⓞ key.

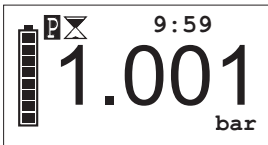

The measurement is started. The measured values and the remaining measurement time are indicated.

The end of measurement is indicated by an audible signal.

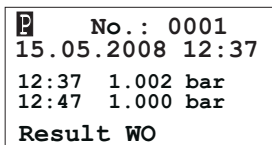

The appropriate protocol is indicated on the display for approx. 30 seconds. The measurement is stored.

- Confirm the displayed protocol with the **Ⓢ** key. The **Client/Meter no.** menu appears.
- If necessary use the **▲** or **▼** key to select the menu item **Client no.**. Enter a Client no. (max. 6 digits).
- If necessary use the **▲** or **▼** key to select the menu item **Meter no.**. Enter a Meter no. (max. 8 digits)
- Use the **▲** or **▼** key to select the menu item **Continue**. The device will return to measuring mode.

The appropriate protocol can be called up in the User menu via the menu item **Protocols** (see section 3.1.8).

### 3.1.6 Regulator inspection



#### **CAUTION!**

Regulator inspection may only be carried out by sufficiently qualified members of staff who are familiar with the prevailing national regulations (in Germany, for example: TRGI). All relevant safety procedures and accident prevention regulations have to be taken into account.

Regulator inspection are used to check controllers and safety instruments. For this, five individual tests can be performed with the instrument.



#### **Note:**

It is not possible to select Regulator inspection as default start mode.

#### 3.1.6.1 Preparations

- Switch the instrument on.
- Connect the instrument to the supply system. Use the corresponding quick-release connection for this which is installed on the instrument.
- Apply the required testing pressure.

#### 3.1.6.2 Execution

The following describes the general procedure for a regulator inspection. Please note the special information regarding the individual tests in sections 3.1.6.3 – 3.1.6.7.

- Press the ▲ or ▼ key for approx. two seconds to access the User menu.
- Use the ▲ or ▼ key select the menu item **Regulator ins.**
- Confirm with Ⓞ key.

The display shows the **Regulator ins** menu:

Dynamic pr.
Static pr.
Reaction pr.
Zero shut-off
Low flow safe
Exit

- Use the ▲ or ▼ key to select the desired individual test.
- Confirm with Ⓢ key.

The selected test and the measured value appear on the display.

- Use the ▲ or ▼ key to select the desired option (e. g. **Store**, **WO**; for further information see sections 3.1.6.3 – 3.1.6.7).
- Confirm with Ⓢ key.

The relevant values and entries are stored for the protocol. The instrument returns to the **Regulator ins** menu.



**Note:**

If you select **Exit** in the dialogues of the individual tests, no values will be stored for the protocol.

- Carry out further individual tests in the same way.



**Note:**

If the test is repeated, the stored values are overwritten.

Use the ▲ or ▼ the key to select the menu item **Exit**.

<b>R</b>	No. : 0004
	15.05.2008 13:45
	22.0 / 23.0 mbar
	SAV 60.9 mbar
	Zero shut-off WO
	Low flow safe WO

The appropriate protocol is indicated on the display for approx. 30 seconds. The measurement is stored.

- Confirm the displayed protocol with the Ⓞ key. The **Client/Meter no.** menu appears.
- If necessary use the ▲ or ▼ key to select the menu item **Client no.** Enter a Client no. (max. 6 digits).
- If necessary use the ▲ or ▼ key to select the menu item **Meter no.** Enter a Meter no. (max. 8 digits).
- Use the ▲ or ▼ key to select the menu item **Continue.** The device will return to measuring mode.

The stored protocols can be called up in the User menu via the menu item **Protocols** (see section 3.1.8).

#### 3.1.6.3 Dynamic pressure

This test is used to check the regulation function of the gas regulator with the consumers being **switched on**.

Store
Exit

After the dynamic pressure has settled:

- Select **Store**.
- The value is stored for the protocol.

#### 3.1.6.4 Static pressure

This test is used to check the regulation function of the gas regulator with the consumers being **switched off**.

Store
Exit

After the static pressure has settled:

- Select **Store**.
- The value is stored for the protocol.

### 3.1.6.5 Reaction pressure inspection

This test is used to determine the **upper** switching-off point of the safety shut-off valve.

Store
Exit

After the safety shut-off valve is triggered (distinctly audible):

- Confirm the value **immediately** with **Store**.
- The value is stored for the protocol.

### 3.1.6.6 Zero shut-off

This test is used to check the safety shut-off valve for leaks.

WO
not OK
none
Exit

If you want to skip the zero shut-off test:

- Select the option **none**.
- An appropriate entry is generated in the protocol.

### 3.1.6.7 Low-pressure cut-off valve (Low flow safe)

This test is used to check the function of the low-pressure cut-off valve.

WO
not OK
missing
Exit

If you want to skip the test of the low-pressure cut-off valve (e. g., because the valve is not installed at all):

- Select the option **missing**.
- An appropriate entry is generated in the protocol.

### 3.1.7 Start measurement/Stop measurement/Store

Measurements must always be started. Starting a measurement is explained separately for each testing mode in the section title **Performing measurements**.

At the end of the measuring period the measurement is automatically saved. A consecutively increasing number is assigned to every measurement. It is possible to store max. 122 measurements. If all memory locations are assigned, the instrument starts to overwrite the oldest measurements (FIFO memory ["First In, First Out"]).

#### **Simplified method for starting a measurement**

Starting a measurement can be simplified, provided that the applied pressure is greater than 5 mbar.

- Press the  key and release it **quickly**. The measurement starts.





If the described condition is not complied with, pressing the key will only switch on the light.

#### **Test of working order**

If the measurement time is preset to 0 minutes, the menu item **Store** will appear instead of **Start meas..** The measurement is stored immediately.

#### **Cancel measurement**

Ongoing measurements can be cancelled.

- Press the  or  key for approx. two seconds to access the User menu.
- Use the  or  key to select the menu item **Stop meas..** The measurement is stopped.

Despite the cancellation, a protocol of the measurement is saved. It contains the note: „Measurement cancelled“.



### 3.1.8 Protocols

The measurement results are stored to permit documenting the measurements. Stored measurements can be viewed, printed, transmitted or deleted in the **Protocols** menu.

To access the **Protocols** menu:

- Press the ▲ or ▼ key for approx. two seconds to access the User menu.
- Use the ▲ or ▼ key to select the menu item **Protocols**.
- Confirm the selection with the Ⓢ key.

A brief message appears indicating the number of stored protocols. Then, the last stored protocol is displayed.

Examples:

```

P      No.: 0001
15.05.2008 12:37
12:37  1.002 bar
12:47  1.000 bar
Result WO
  
```

**Preliminary Test**

```

M      No.: 0002
15.05.2008 13:00
12:37  150.5 mbar
12:47  150.3 mbar
Result WO
  
```

**Main test**

```

W      No.: 0003
15.05.2008 13:22
1.0 l/h 22 mbar
Result LWO
  
```

**Test of working order**

```

R      No.: 0004
15.05.2008 13:45
22.0 / 23.0 mbar
SAV    60.9 mbar
Zero shut-off WO
Low flow safe WO
  
```

**Regulator inspection**

- Press the ▲ or ▼ key to select a specific protocol.
- Confirm the selection with the Ⓞ key.

The **Protocols menu** appears.

Print
Send
Send all
Clear
Clear all
Exit

- Press the ▲ or ▼ key to select a specific command.
- Confirm the selection with the Ⓞ key.

The command is executed. The display returns to the measuring mode.



**Note:**

To permit execution of the commands **Print**, **Send** and **Send all**, it is required to align the **MiniLec 4** with the receiving instrument (see chapter 2.3).

If no receiving instrument is detected, the search run is interrupted after two minutes. The instrument returns to the Protocols menu.

The search run can be cancelled any time by pressing the Ⓞ key.

### Printing protocols

The Client and Meter nos. also appear on the printed test protocol if both were entered when the measurement was saved.

## 3.2 Extended settings

The extended settings permit to adjust the following functionalities of the instrument:

- Adjustment
- System
- Hardware
- Parameters
- Memory

It is not possible to carry out a measurement when the extended settings are opened.

### 3.2.1 Access

There are two ways to call up the **extended settings**:

The instrument is **switched off**:

- Press simultaneously the  $\text{Ⓢ}$ ,  $\text{▲}$  and  $\text{▼}$  keys, for approx. 2 seconds.

The instrument is in the **measuring mode**:

- Press simultaneously the  $\text{▲}$  and  $\text{▼}$  keys for approx. 2 seconds.

The following display appears:

**PIN** 0000

The access is protected by a PIN code. As **default**, **PIN Code 0001** is always pre-set.

A specific setting is available for the **MiniLec 4** instrument determining that only authorised members of staff have access to the Info menu.

It is recommended to set another PIN code after taking the instrument into service.



**Note:**

If the PIN code is set to 0000, no PIN code query is carried out. The extended settings will then be freely accessible.

If you cannot call up the extended settings (e. g., you have forgotten the PIN code), it is required to contact the SEWERIN service.

The PIN code has to be entered from left to right. The currently active digit is always indicated on a black background:

- Select the desired digit with the help of the ▲ or ▼ key.
- Confirm the selection with the Ⓢ key.
- Enter all digits of your code.

If the PIN code was entered correctly, the **Info menu** will appear after confirming the last digit:

Adjustment
System
Hardware
Parameter
Memory
Exit

Otherwise the instrument returns to the measuring mode.

### 3.2.2 Procedure

The extended settings are divided into three levels.

- The two first levels are used to subdivide and categorise the setting options.
- The third level is used for the actual selection or entry.

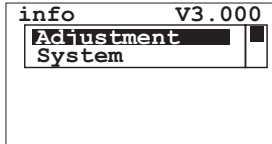

The name of the current menu is always indicated in the top left corner.

The selection options appear in a frame below it.

In addition, the firmware version number (e. g. V3.000) is indicated in the Info menu (top level).

Use the ▲ or ▼ key to navigate within a menu.

Use the Ⓞ key to confirm the selected menu item.

On the two first menu levels, the menu item **Exit** is always indicated at the end of a menu.

If this item is selected, the display returns to the preceding menu.

Exception: From the top level, the instrument returns to the measuring mode.

On the third menu level, you can select settings or enter values:

#### ● Selection of settings

Use the ▲ or ▼ key to navigate within a selection list.

Use the Ⓞ key to confirm the selected setting.

After confirming the setting the display returns to the preceding menu.

- **Entering values**

The position at which the entry is to be inserted is always indicated on a black background:

Use the ▲ or ▼ key to increase or decrease the value.

Use the Ⓢ key to confirm the selected value.



**Note:**

It is always required to confirm all values. Values can only be specified in forward direction. It is not possible to cancel the entry of values.

After confirming the last value, the display returns to the preceding menu.

### 3.2.3 Info menu

The Info menu can be found on the top level of the extended settings:

Adjustment
System
Hardware
Parameter
Memory
Exit



**Note:**

If you select **Exit** in the **Info menu**, the instrument returns to the measuring mode.

#### 3.2.3.1 Adjustment menu

The Adjustment menu is used for setting the sensors.

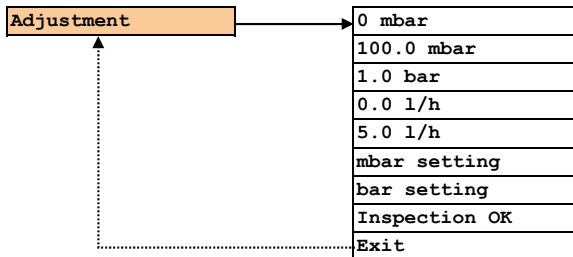

**CAUTION!**

The instrument may only be adjusted by sufficiently qualified members of staff. Incorrect adjustments may result in wrong evaluations of the measurement results.



**Note:**

When performing an adjustment, always follow the advice in section 5.2.

#### 3.2.3.2 System menu

The System menu is used to set general details and specifications for operation, inspection and documentation.

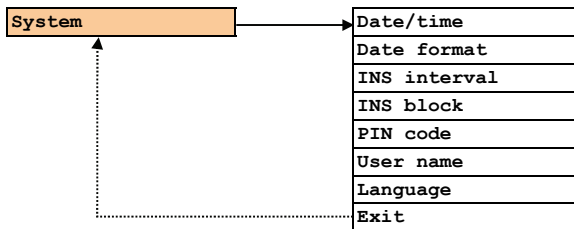

15.05.2008 09:00
------------------

#### Date/time

Entry of date and time. This setting is important to document the measurements.

DD.MM.YYYY
YYYY-MM-DD

#### Date format

You can select between two date formats.

weeks 00
----------

#### INS interval

The inspection interval reminds you of regular inspections/adjustments of the instrument.

yes
no

#### INS block

If the inspection lock is enabled, an inspection must be carried out at the next due date. Only after the due inspection has been performed and confirmed, the instrument can be re-used for measurements.



PIN 0000
----------

### PIN code

Entry of a user-defined PIN code.

City Council
Frank Smith
Leakage Delivery

### User name

Entry of the user name. This setting is important to document the measurements.

Entering a user name is explained in section 7.5.

Deutsch
English
Español
...

### Language

Different languages are available for operating the instrument.

### 3.2.3.3 Hardware menu

The Hardware menu includes settings which can be used to operate the instrument.

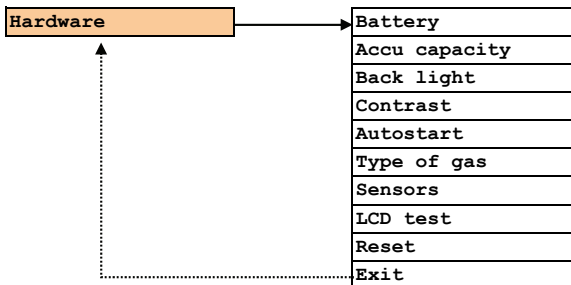

Accu Ni-MH
Alkaline

### Battery

Selection of the used battery type. This setting is important for calculating the service life.

mAh 1850
----------

#### Accu capacity

Entry of the accumulator capacity. This setting is important for calculating the service life.

sec 010
---------

#### Back light

Entry of the time how long the LCD remains illuminated after receiving a signal.

0 - 100%
----------

#### Contrast

Contrast settings to permit better legibility of the LCD.

Working order
Main test
Pre test

#### Autostart

Selection of the test type which is enabled after switching on the instrument.

CH4
C3H8
C4H10
TGAS
H2

#### Type of gas

Selection of the used operating medium.



#### Note:

If **air** or **nitrogen** is used, the type of gas, **CH4**, must be set.

Sensors
---------

#### Sensors



#### CAUTION!

The sensor settings may only be set or modified by the SEWERIN service!

LCD test

### LCD test

For checking the functionality of the LCD.

Reset

### Reset

All customized settings are reset to the default settings.

#### 3.2.3.4 Parameters menu

The Parameters menu is used to modify the default settings of the measurements.

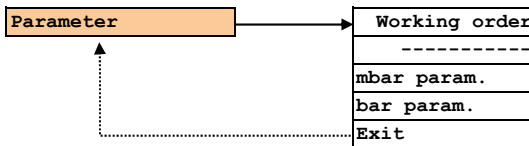

Working order  
 Meas.time 00 min  
 WO < 1.0 l/h  
 NWO ≥ 5.0 l/h

### Test of working order

Setting measurement time and limit values.

mbar param.  
 Meas.time 10 min  
 Pmin = 100 mbar  
 dp < 0.1 mbar

### Main test

Setting measurement time, lowest pressure and max. permissible pressure change.

bar param.  
 Meas.time 10 Min  
 Pmin = 0.20 bar  
 dp < 20 mbar

### Preliminary Test

Setting measurement time, lowest pressure and max. permissible pressure change.

#### 3.2.3.5 Memory menu

The Memory menu is used to delete the recorded measurements. No other settings are affected by this.

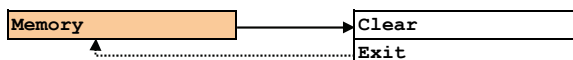

### 4 Charging and battery operation

The instrument can be operated with two different types of batteries:

- Nickel metal hydride accumulators (rechargeable)
- Alkaline batteries (non-rechargeable)

Prescribed type: AA cells

Recommended manufacturers: Sanyo, Varta or Duracell

To ensure that the time required for recharging and of the remaining operating time is indicated correctly, the following settings need to be modified in the extended settings:

- Accu type (Info menu – Hardware – Battery)
- Capacity of the used accumulator types (Info menu – Hardware – Accu capacity).

As default, the instrument is delivered with nickel metal hydride accumulators. The corresponding settings are stored.

#### 4.1 Operation with rechargeable nickel metal hydride accumulators (NiMH)



The accumulators are recharged by the docking station HG4 which is included in the scope of delivery.

This station can either be used in the workshop or in the company car.



### CAUTION!

To ensure trouble-free operation, the following instructions have to be taken into account:

- The docking station must not be connected directly to the 24 V onboard power supply of the vehicle. This voltage is too high for charging.
- The accumulator should roughly have ambient temperature for recharging.
- Short usage times and long periods without using the instrument can reduce the available accumulator capacity (memory effect).

### Optional connections of the docking station:

- AC/DC adapter M4 for 100 – 240 V~
- Vehicle cable M4 12 V= mounting
- Vehicle cable M4 12 V= mobile
- Vehicle cable M4 24 V= mobile



### Note:

You can connect up to three docking stations to a single 100 – 240 V ~ power supply unit. If four or more docking stations are connected, the charging voltage is too low. In this case, an error message appears on the display.

### Charging procedure:

- **Switch off** the instrument and put it into the docking station.

The time required for a complete recharging cycle is indicated.

If the accumulators are completely recharged, the instrument switches automatically to charge retention.

It can remain in the docking station until the next use.

After recharging the instrument for min. 12 hours (depending on the accumulator capacity), it is ready to be used for at least 20 hours.

**Note:**

If the instrument is switched off and kept outside the docking station, the nickel metal hydride accumulators start to discharge. After max. 30 days the accumulators are completely discharged.

To retain the accumulator capacity, it is required to completely discharge the instrument regularly (e. g. once a month) before recharging it.

**Discharging procedure:**

- **Switch on** the instrument and put it into the docking station.
- The accumulators are completely discharged. After the discharging procedure, the instrument automatically changes to recharging.

A complete recharge/discharge cycle takes approx. 32 hours (20 hours for discharging + 12 hours for recharging).

**Note:**

If you replace alkaline batteries by nickel metal hydride accumulators, the indicated operating hours may not be correct. In this case, the instrument must be switched on and put into the docking station so that it can automatically perform a discharge/recharge cycle. After that, the correct number of operating hours will be indicated.

## 4.2 Operation with non-rechargeable alkaline batteries



### **CAUTION!**

A instrument operated with alkaline batteries cannot be recharged in the docking station. If this instrument is put into the docking station, a corresponding message appears on display.

The **MiniLec 4** instrument can be operated with new alkaline batteries for at least 20 hours.

Proceed as follows to replace batteries or accumulators:

- Loosen the two lower screws on the back panel of the instrument using the supplied screwdriver.
- Open the battery compartment.
- Insert the new cells. Ensure that the batteries are properly inserted to maintain correct polarity.
- Close the battery compartment.
- Retighten the two lower screws on the back panel of the instrument.



### **Note:**

If it takes more than 120 seconds to replace the batteries, you need to re-enter date and time the next time you switch on the instrument. All other data remains stored.

### 5 Maintenance

The maintenance inspections for the device are divided into the following areas:

- Functional test/inspection
- Check to ensure the indication accuracy and the leak-tightness of the device
- Adjustment
- Maintenance and repair

#### 5.1 Functional test/inspection

The functional test is performed by the user before commencing work.

The following elements must be tested:

- External condition of the device
- Function of controls
- Battery charge status
- Zero point

#### 5.2 Check to ensure the indication accuracy and leak-tightness of the device

The indication accuracy and the leak-tightness of the device must be checked at least once a year.

SEWERIN recommends that these tests also be performed if any irregularities occur during measuring or the measuring results are inexplicable.

Checking the leak-tightness of the device means checking that the **MiniLec 4** itself is leak-tight. This check must not be confused with the leak test (see section 3.1.4).

Both tests are carried out using a **MiniLec 4 tester** (see section 7.6.2).



### 5.3 Adjustment

The device may only be adjusted by SEWERIN Service or an approved technician/service company.

After adjustment a device which has been locked for inspection, can be released again for use. This setting can be adjusted in the **Adjustment menu**.



**Note:**

The adjustment settings can be reset in the **Hardware menu** under **Reset**.

### 5.4 Maintenance and repair

The device must only be serviced and repaired by SEWERIN Service.

- Send the device to SEWERIN for repairs and for annual maintenance.



**Note:**

If there is a service agreement in place, the device can be serviced by the mobile maintenance service.

## 6 Errors

If errors occur during regular operation, a corresponding message appears on the display. The appropriate error number and name are indicated.

<b>Error code</b>	<b>LCD (error name)</b>	<b>Cause</b>	<b>Remedy</b>
10	W ZERO POINT ADJUSTMENT	An error occurred during adjusting the zero point	Check the flow rate. Repeat adjustment. See section 3.2.3.1 and 5
11	M ZERO POINT ADJUSTMENT	An error occurred during adjusting the zero point	Check pressure 0.0 mbar. Repeat adjustment. See section 3.2.3.1 and 5
12	P ZERO POINT ADJUSTMENT	An error occurred during adjusting the zero point	Check pressure 0.0 mbar. Repeat adjustment. See section 3.2.3.1 and 5
13	W SPAN ADJUSTMENT	An error occurred during adjusting the flow rate	Check the flow rate. Repeat adjustment. See section 3.2.3.1 and 5
14	M SPAN ADJUSTMENT	An error occurred during adjusting the pressure	Check pressure. Repeat adjustment. See section 3.2.3.1 and 5
15	P SPAN ADJUSTMENT	An error occurred during adjusting the pressure	Check pressure. Repeat adjustment. See section 3.2.3.1 and 5
51	int. RAM SERVICE	An error occurred in the internal RAM	Only the SEWERIN service may perform troubleshooting.
52	XFLASH SERVICE	An error occurred in the program/ data memory	Only the SEWERIN service may perform troubleshooting.
53	AD Con. SERVICE	An error occurred in the analogue converter	Only the SEWERIN service may perform troubleshooting.
54	DISPLAY SERVICE	A display error occurred	Only the SEWERIN service may perform troubleshooting.

## 7 Appendix

### 7.1 Equipment and permissible ranges of use

Dimensions (W × H × D):	approx. 60 × 160 × 40 mm
Weight:	approx. 300 g
Type of protection:	IP54
Power supply:	3 Cells, Type Mignon AA , via: <ul style="list-style-type: none"> <li>● Accumulators: NiMH</li> <li>● Batteries: Alkaline</li> </ul>
Operation time:	20 h
Recharge NiMH accumulators:	via charging: <ul style="list-style-type: none"> <li>● docking station HG4</li> <li>● AC/DC adapter with 12-V-Interface</li> </ul>
Charging time NiMH accumulators:	14 h (complete recharge), depending on the capacity
Charging voltage:	12 V DC, 360 mA (synchronised)
Operating temperature:	-10 °C – +40 °C
Storage temperature:	-20 °C – +70 °C
Pressure:	860 – 1100 hPa
Permissible relative humidity:	0 – 90 % r.h., non-condensing
Sensors:	<ul style="list-style-type: none"> <li>● Flow rate sensor for Test of working order</li> <li>● Pressure sensor for Test of working order, Main test, Preliminary test, Regulator inspection</li> </ul>
Types of gas:	<ul style="list-style-type: none"> <li>● Methane CH<sub>4</sub> / air / natural gas</li> <li>● Propane C<sub>3</sub>H<sub>8</sub></li> <li>● Butane C<sub>4</sub>H<sub>10</sub></li> <li>● Town gas</li> <li>● Hydrogen H<sub>2</sub></li> </ul>
Infrared interface:	IrDA 1.0 <ul style="list-style-type: none"> <li>● Printing: IrCOMM 3-Wire Raw</li> <li>● Transmitting: Multi-Transport OBEX</li> </ul>
PC interface:	via: <ul style="list-style-type: none"> <li>● Docking station HG4 with Interface</li> <li>● Infrared interface</li> </ul>
Memory:	Capacity 122 memory locations
LCD:	Graphic display, 65 × 132 pixels
Buzzer:	<ul style="list-style-type: none"> <li>● Frequency: 2.4 kHz</li> <li>● Volume: 70 dB (A) / 1 m</li> </ul>
Signal light:	red
Operation:	<ul style="list-style-type: none"> <li>● Foil key pad with 3 keys</li> </ul>
Certificate:	DVGW: <ul style="list-style-type: none"> <li>● VP 952, Device class L</li> <li>● Product identification no. DG-4805BT0149</li> </ul>

## 7.2 Sensors

### Pressure sensor

Used for:	<ul style="list-style-type: none"><li>• Test of working order</li><li>• Main test</li><li>• Regulator inspection</li></ul>
Measuring range:	0 – 200 mbar
Resolution:	0.1 mbar
Measuring error:	±5 % of end of measuring range

Used for:	Preliminary test
Measuring range:	0 – 2 bar
Resolution:	0.001 bar
Measuring error:	±5 % of end of measuring range

### Flow rate sensor

Used for:	Test of working order
Measuring range:	0 – 10 l/h
Resolution:	0.1 l/h
Measuring error:	0.1 l/h resp. 5 % of measured value

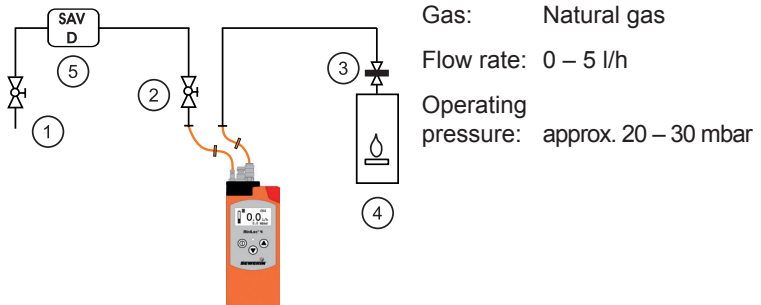

## 7.3 Connection and application options

### Replacement of a meter, Test of working order

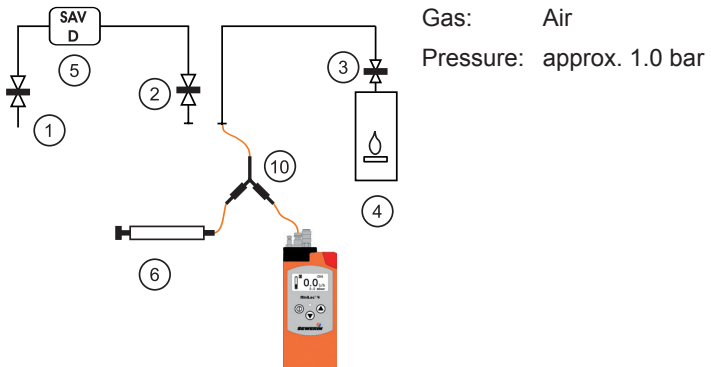

### Preliminary test



- Legende:
- 1 Main stop device
  - 2 Meter-locking device
  - 3 Equipment-locking device
  - 4 Consumer
  -  switched off
  - 5 Controller + Safety shut-off valve (SAV)
  - 6 High performance pump
  - 10 Y-piece with two ball valves
-  closed  
 open

**Main test**

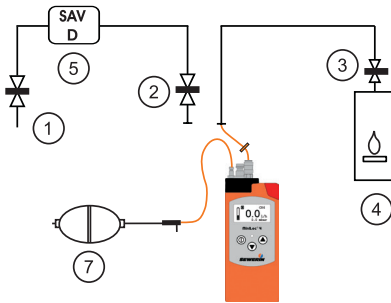

Gas: Air  
 Pressure: approx. 150 mbar

**Check of non-metered pipes**

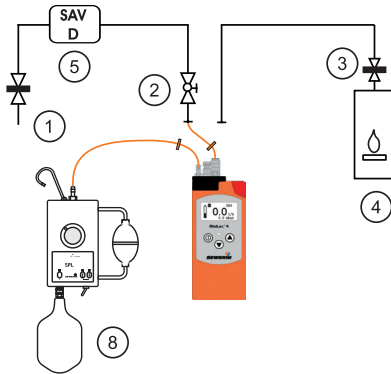

Gas: Natural gas  
 Flow rate: 0 – 5 l/h  
 Operating pressure: approx. 20 – 30 mbar

**Test of working order at an arbitrary place of the pipe**

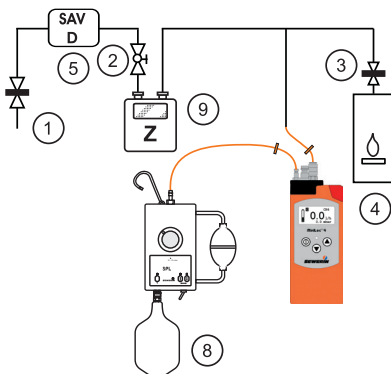

Gas: Natural gas  
 Flow rate: 0 – 5 l/h  
 Operating pressure: approx. 20 – 30 mbar

## Regulator inspection/Static pressure

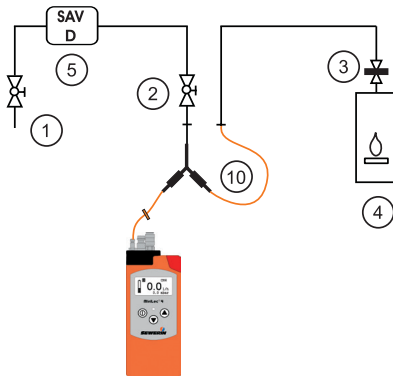

Main stop device: open  
 Gas: Natural gas  
 Operating pressure: approx. 20 – 30 mbar

## Regulator inspection/Dynamic pressure

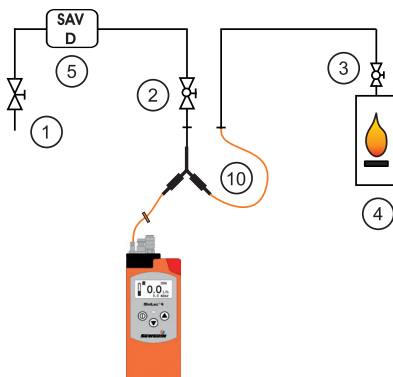

Main stop device: open  
 Gas: Natural gas  
 Operating pressure: approx. 20 – 30 mbar

Legende:

1 Main stop device

2 Meter-locking device

3 Equipment-locking device

4 Consumer



switched off



closed



open



switched on

5 Controller + Safety shut-off valve (SAV)

7 Hand pump

8 Feeding device SPL

9 Meter

10 Y-piece with two ball valves

### Regulator inspection/Reaction pressure inspection

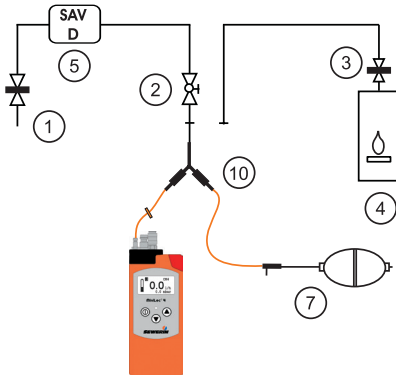

Main stop device: closed  
Gas: Air  
Pressure: depending on the upper switching-off point of the safety shut-off valve (typical: 50 – 100 mbar)

### Regulator inspection/Zero shut-off

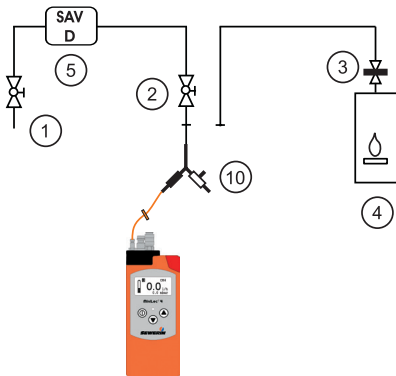



Main stop device: open  
Operating pressure: 0 mbar

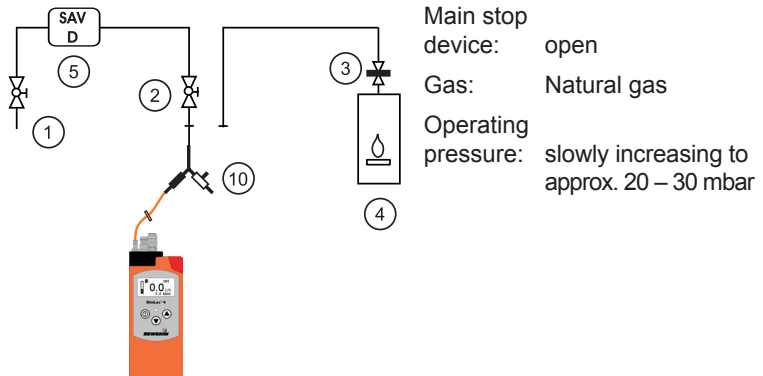

## Regulator inspection/low-pressure cut-off valve



- Legende:
- 1 Main stop device
  - 2 Meter-locking device
  - 3 Equipment-locking device
  - 4 Consumer
  -  switched off
  - 5 Controller + Safety shut-off valve (SAV)
  - 7 Hand pump
  - 10 Y-piece with two ball valves
-  closed  
 open

## 7.4 Entering a user name

The user name is stored in the advanced settings (System menu). The advanced settings are explained in section 3.2. Access is explained in section 3.2.1.

Use the ▲ and ▼ keys to enter the characters.

All characters present must be confirmed.

### 1. Possibility: New entry, no existing sign to be overwritten.

Entry starts with a blanc (black block).

Letters A - Z can be chosen in alphabetical order with ▲ key.

After reaching letter Z the menu starts again with letter A.

Letters Z - A can be chosen downwards with ▼ key.

After letter A the additional characters

@≤>=<.;9876543210/.-,+\*)('&%\$#"!

are displayed.



**Note:**

The additional characters can only be chosen with ▼ key.

The chosen letter is confirmed with Ⓢ key.

The instrument automatically goes to the next letter.

After confirming the last letter of the user name, the instrument returns to the System menu.

## 2. Possibility: An existing letter has to be overwritten.

When the position is changed, the existing character is highlighted with a black block.

The blanc appears when pressing  key, thereafter letters A - Z can be chosen as described on the previous page.

After reaching letter Z the menu starts again with letter A.

When pressing  key the previous letter of the alphabet appears, all others appear in descending order.

After letter A the additional characters  
@≤>=<;:9876543210/.,+\*)('&%\$#“!  
are displayed.

The chosen letter is confirmed with the  key.

The instrument automatically goes to the next letter.

After confirming the last letter of the user name, the instrument returns to the system menu.

**Note:**

It could occur that during entry blancs a displayed by a black block. This only happens in entry mode. The actual display shows the correct blancs.

## 7.5 Delivery variants and accessories

### 7.5.1 Delivery variants



#### MiniLec 4 – version HP

Part No.: LH04-10101

- Preliminary test  
(Connection: Rectus 21 nipple)
- Main test  
(Connection: Rectus 20 nipple)
- Regulator inspection  
(Connection: Rectus 20 nipple)
- Test of working order  
(Connection  
Inlet: Rectus 20 nipple  
Outlet Rectus 20 coupling)
- Data memory
- Infrared interface



#### MiniLec 4 – version LP

Part No.: LH04-10001

- Main test  
(Connection: Rectus 20 nipple)
- Regulator inspection  
(Connection: Rectus 20 nipple)
- Test of working order  
(Connection  
Inlet: Rectus 20 nipple  
Outlet Rectus 20 coupling)
- Data memory
- Infrared interface

## 7.5.2 Accessories

Following is a selection of accessories for the MiniLec 4. We are happy to provide information regarding further accessories.



### Case MiniLec 4

Part No.: ZD22-10000

- Size SR/VT
- with foam insert and compartments for multi-purposes
- to accommodate the following:
  - MiniLec 4
  - Charging technique
  - Printer
  - Test hoses
  - Test connections
  - Feeding devices SPL
  - Pumps



### Docking station HG 4

Part No.: LP10-10001

- for charging the instrument

### Docking station HG 4 with interface

Part No.: LP10-10101

- for charging the instrument and to read-out the measuring data
- with RS-232-cable



**AC/DC adapter M4**

Part No.: LD10-10001

- 100 – 240 V~/12 V=



**Thermo-printer and AC/DC adapter**

Part No.: 3001-0018

- Printer with infrared interface for printing via MiniLec 4 or palmtop computer
- Printing out the measurement results without graphics



**Inlet hose**

Part No.: LH04-Z0100

- Instrument: Rectus 20 coupling
- Installation: Rectus 21 coupling
- Length 1.5 m
- incl. hydrophobic filter
- for Main test and Test of working order



**Outlet hose**

Part No.: LH04-Z0200

- Instrument: Rectus 20 nipple
- Installation: Rectus 21 coupling
- Length 1.5 m
- incl. hydrophobic filter
- for Main test and Test of working order



### Connection hose

Part No.: LH04-Z0300

- Instrument:  
Rectus 21 coupling
- Installation:  
Rectus 21 coupling
- Length 1.5 m
- for Preliminary test;  
optional: also for other tests.



### Test stoppers for two-pipe gas meter, e. g. DN 25 G 1¼

Part No.: LH04-Z1900

- with ball valve and  
Rectus 21 nipple
- for connections with swivel  
nuts
- 2 pcs. are always required
- other dimensions available



### Overflow cap DN 25 for one-pipe gas meter connection

Part No.: LH04-Z0500

- Thread G2
- ball valve and Rectus 21 nipple
- for checking the supply line  
and consumption line at the  
same time
- Preliminary test and Main test



**Test cap DN 25 for one-pipe gas meter connection**

Part No.: LH04-Z0600

- Thread G2
- with two ball valves and Rectus 21 nipple
- for checking the supply line (non-metered) and consumption line apart from each other
- for all test types

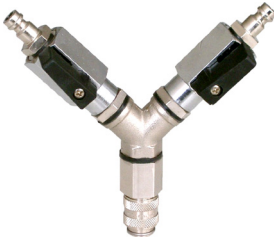

**Y-piece with two ball valves**

Part No.: LH04-Z2300

- 1 x coupling Rectus 21, 2 x nipple Rectus 21
- for Preliminary test; optional: also for other tests



**Feeding device SPL-AUTO**

Part No.: ZZ23-10100

- automatic filling of the gas bubble with the help of a built-in electrical pump
- for serviceability determinations of **non-metered** pipes and for checks at an arbitrary place of the pipe





## High performance pump with manometer

Part No.: LH04-Z0800

- for Preliminary test

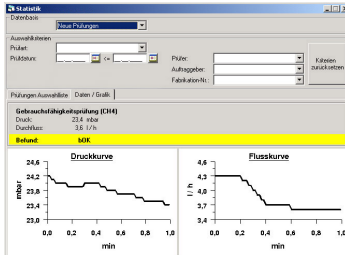

## MiniLec 4 Desktop

Part No.: LH04-82000

- Software for the central recording, processing and managing of measurement data on the PC



## Test set MiniLec 4 HP

Part No.: ZP08-10000

- for checking pressure sensors and flow rate sensor of the MiniLec 4 HP



## Test set MiniLec 4 LP

Part No.: ZP08-10100

- for checking pressure sensors and flow rate sensor of the MiniLec 4 LP

**7.6 Declaration of conformity**

Hermann Sewerin GmbH hereby declares that the **MiniLec® 4** fulfils the requirements of the following guideline:

- 2014/30/EU

Gütersloh, 2016-04-20

A handwritten signature in black ink, appearing to read 'S. Sewerin', written in a cursive style.

Dr. S. Sewerin  
(General Manager)

The complete declaration of conformity can be found online.

## 7.7 Advice on disposal

The European Waste Catalogue (EWC) governs the disposal of appliances and accessories.

Description of waste	Allocated EWC waste code
Device	16 02 13
Test gas can	16 05 05
Battery, accumulator	16 06 05

### Old instruments

Old instruments can be returned to Hermann Sewerin GmbH. We will arrange for the appliance to be disposed of appropriately by certified specialist contractors free of charge.

**7.8 Terminology and abbreviations**

dP	Maximum permissible pressure change
DVGW	Deutsche Vereinigung des Gas- und Wasserfaches e.V. [German Technical and Scientific Association for Gas and Water]
IrDA	Infrared Data Association, interface standard used for communication
LCD	Liquid Crystal Display
NiMH	Nickel metal hydride
P <sub>min</sub>	Lowest pressure
SAV	Safety shut-off valve
TRGI	Technical rules for gas installations (applies only in Germany)

---

## 8 Index

### A

Accu capacity 34, 36  
Adjustment 41  
Adjustment menu 31  
Ambient pressure 3  
Autostart 34

### B

Back light 34  
Battery  
  Battery type 33  
  Charging operation 36  
  Replacement 38  
Battery operation 36

### C

Charging time 37  
Check to ensure the indication accuracy 40  
Connection options 45  
Connections 4  
  Main test 4  
  Preliminary test 4  
  Printer 6  
  Quick-release connection 4  
  Regulator inspection 4  
  Test of working order 4  
Contrast 34

### D

Data transmission 6  
Date format 32  
Device inspection 40  
Docking station 36  
DVGW 2

### E

Error message 42  
Extended settings 27

### F

Firmware  
  Version 7

### G

Gas 3

### H

Hardware menu 33

### I

Info menu 28, 31  
Infrared interface 6, 43  
INS block 32  
INS interval 32  
Inspection 40  
Instrument  
  Equipment 4, 43  
  Operation 7  
  Recharging 36  
  Versions 4

### L

Language 33  
LCD  
  Display 43  
  Test 35  
Leak-tightness of the device 40

### M

Maintenance 41  
Main test  
  Execution 15  
  Preparations 15  
Measuring data 8, 9  
Measuring mode 7, 9  
Measuring principle  
  Flow 12  
  Return flow 12  
Measuring range 8, 9

### Memory

- Capacity 24, 43
- Delete 35

Memory menu 35

### O

- Operating pressure 3
- Operating temperature 3

### P

- Parameters 8, 9
- Parameters menu 35
- PC 6
- PIN code 27, 33
- Preliminary test
  - Execution 18
  - Preparation 18
- Printer 6
- Protocols
  - Deleting 25
  - Printing 25
  - Transmitting 25
  - Viewing 25
- Protocols menu 26

### R

- Regulator inspection
  - Execution 20
  - Preparations 20
- Repair 41
- Reset 35

### S

- Sensors 34, 44
- Service 40
- Signal light 5, 43
- Signal tone 5
- Storage temperature 3
- System menu 32

### T

- Test mode 8
- Test of working order
  - Execution 12
  - Preparations 12
- Test pressure

Main test 3

Preliminary test 3

Regulator inspection 3

Test of working order 3

TRGI 12, 14, 15, 17, 20

Type of gas 3, 34

### U

- User menu 10
- User name 33

### V

- Versions
  - HP 4
  - LP 4

**Hermann Sewerin GmbH**  
Robert-Bosch-Straße 3 · 33334 Gütersloh · Germany  
Telefon +49 5241 934-0 · Telefax +49 5241 934-444  
[www.sewerin.com](http://www.sewerin.com) · [info@sewerin.com](mailto:info@sewerin.com)