

# Operating Instructions

**AQUAPHON® AF 100**  
**FERROPHON® EL**



## **Measurable success by Sewerin equipment**

---

Congratulations. You have chosen a quality instrument manufactured by Hermann Sewerin GmbH.

Our equipment will provide you with the highest standards of performance, safety and efficiency. They correspond with the national and international guide-lines.

Please read and understand the following operating instructions before using the equipment; they will help you to use the instrument quickly and competently. If you have any queries we are available to offer advice and assistance at any time.

Yours

### **Hermann Sewerin GmbH**

Robert-Bosch-Straße 3  
33334 Gütersloh, Germany  
Tel.: +49 5241 934-0  
Fax: +49 5241 934-444  
www.sewerin.com  
info@sewerin.com

### **SEWERIN SARL**

17, rue Ampère - BP 211  
67727 Hoerdt Cedex, France  
Tél. : +33 3 88 68 15 15  
Fax : +33 3 88 68 11 77  
www.sewerin.fr  
sewerin@sewerin.fr

### **Sewerin Ltd**

Hertfordshire  
UK  
Phone: +44 1462-634363  
www.sewerin.co.uk  
info@sewerin.co.uk

### **SEWERIN IBERIA S.L.**

Centro de Negocios "Eisenhower"  
Avenida Sur del Aeropuerto  
de Barajas 28, Of. 2.1 y 2.2  
28042 Madrid, España  
Tel.: +34 91 74807-57  
Fax: +34 91 74807-58  
www.sewerin.es  
info@sewerin.es

### **Sewerin Sp.z o.o.**

ul. Twórcza 79L/1  
03-289 Warszawa, Polska  
Tel.: +48 22 675 09 69  
Faks: +48 22 486 93 44  
Tel. kom. +48 501 879 444  
www.sewerin.pl  
info@sewerin.pl

# Illustration AQUAPHON AF 100

---

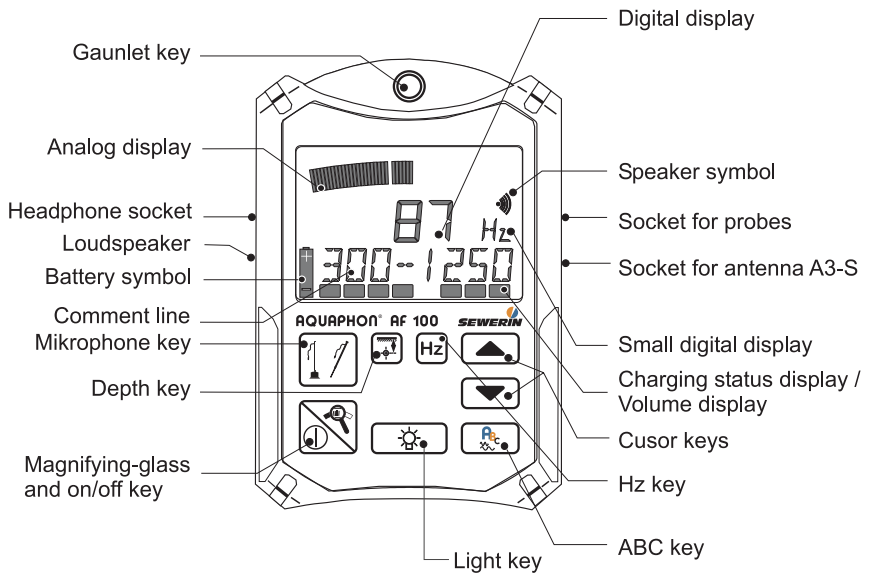

# Illustration FERROPHON EL

---

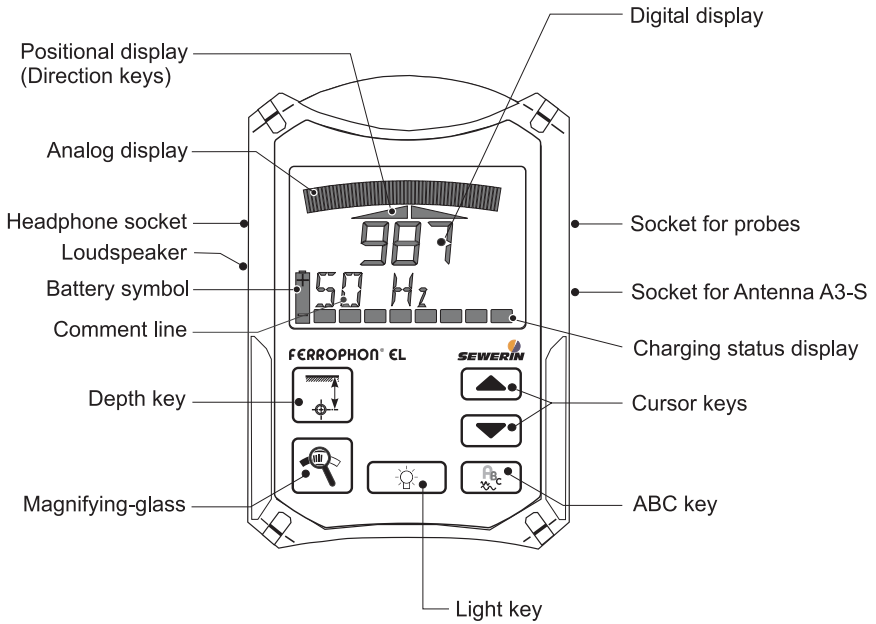

**Operating Instructions**

**AQUAPHON® AF 100**  
**FERROPHON® EL**

20.04.2016 a – V8.X – 104819 – en

---

## Symbol explanation

---



### **CAUTION!**

This symbol warns of dangers that may threaten the safety of the user or may damage or destroy the product.



### **Note:**

This symbol flags information and hints extending beyond the actual operation of the product .

---

<b>1</b>	<b>General</b> .....	<b>1</b>
1.1	Warranty.....	1
1.2	Intended use .....	2
1.3	General notes.....	3
<b>2</b>	<b>Function description</b> .....	<b>4</b>
2.1	Pipeline location (EL/AF 100 only) .....	4
2.2	Water leak detection (AF 100 only).....	5
2.3	Acoustic Pipeline location (AF 100 only).....	6
<b>3</b>	<b>Use</b> .....	<b>7</b>
3.1	Switching on and off.....	7
3.1.1	Manual probe selection .....	8
3.2	Adjusting the display contrast .....	9
3.3	Charging equipment.....	9
3.4	Charging.....	10
3.4.1	Self-discharge .....	11
3.5	Connecting the headphones .....	12
<b>4</b>	<b>Pipeline location (EL/AF 100)</b> .....	<b>13</b>
4.1	Displays.....	13
4.1.1	Positional display .....	13
4.1.2	Analog display.....	13
4.1.3	Frequency display .....	14
4.1.4	Digital display .....	14
4.1.5	Battery status .....	14
4.1.6	Battery warning .....	15
4.1.7	Speaker symbol .....	15
4.2	Key functions.....	16
4.2.1	Frequency selection (ABC key).....	16
4.2.1.1	Direct acoustic output.....	18
4.2.2	Depth key .....	19
4.2.3	Cursor keys .....	19
4.2.4	Magnifying-glass key.....	19
4.3	Probe overview .....	23
4.3.1	Antenna A3-S.....	23
4.3.2	Search coil SK3.....	23
4.3.3	Search coil FS20 .....	23

---

---

4.3.4	Cable clamps AZ5 .....	24
4.3.5	Search coil FS3 A.....	24
4.3.6	Other probes .....	24
4.4	Antenna A3-S .....	25
4.4.1	Displays.....	25
4.4.2	Methods .....	26
4.4.3	Pipeline location .....	28
4.4.4	Locating lines .....	28
4.4.5	Special features when using a generator .....	30
4.4.6	Following a line .....	31
4.4.7	Depth measurement.....	32
4.5	Use with non-metallic lines.....	34
4.5.1	General information on the use with non-metallic lines.....	34
4.5.2	Locating the of the mini pig transmitter .....	36
4.5.3	Depth measurement of the mini pig transmitter .....	40
4.6	Special aspects in practical work .....	41
4.6.1	Inaccuracies of measurement .....	41
4.6.2	Distortions of the field.....	42
4.6.3	Locating cable faults .....	43
4.7	Cable clamp AZ5.....	45
4.8	Search coil SK3.....	46
4.9	Search coil FS20.....	46
4.10	Search coil FS3 A.....	47
4.10.1	Depth determination with the search coil FS3 A.....	48
<b>5</b>	<b>Water leak detection (AF 100) .....</b>	<b>49</b>
5.1	Displays.....	49
5.1.1	Analog display.....	49
5.1.2	Digital display .....	49
5.1.3	Small digital display.....	49
5.1.4	Speaker symbol .....	50
5.1.5	Volume display .....	50
5.1.6	Battery symbol .....	50
5.1.7	Comment line .....	51
5.1.8	Basic amplification .....	51
5.2	Key functions.....	51
5.2.1	Microphone key.....	51
5.2.2	Gauntlet key .....	52
5.2.3	Hz key .....	52
5.2.4	Cursor keys .....	54

---



---

5.2.5	Light key .....	54
5.2.6	Magnifying-glass and on/off key .....	55
5.3	Probe overview .....	56
5.3.1	Ground microphone BO-4 .....	56
5.3.2	Ground microphone 3P-4 .....	56
5.3.3	Carrying rod H-4 .....	56
5.3.4	Test rod T-4 .....	57
5.4	Switching on and off .....	58
5.5	Sound-protection function .....	59
5.6	Preliminary location .....	59
5.7	Pin pointing .....	63
5.8	Individual settings .....	65
5.9	Factory settings (reset) .....	67
<b>6</b>	<b>Brief instruction .....</b>	<b>68</b>
6.1	Brief instruction on pipeline location .....	68
6.2	Brief instruction on water leak detection .....	70
<b>7</b>	<b>Malfunctions .....</b>	<b>72</b>
<b>8</b>	<b>Specifications .....</b>	<b>74</b>
<b>9</b>	<b>Accessories .....</b>	<b>75</b>
9.1	Accessories for Pipeline location .....	75
9.2	Accessories for water leak detection .....	76
9.3	General accessories .....	76
<b>10</b>	<b>Annexe .....</b>	<b>77</b>
10.1	EU declaration of conformity .....	77
10.2	Hints on Disposal .....	78
10.3	Record of changes .....	79
<b>11</b>	<b>Index .....</b>	<b>81</b>

---

# 1 General

## 1.1 Warranty

Hermann Sewerin GmbH bears no liability for damage attributable to non-compliance with these instructions.

The terms of warranty and liability of the conditions of sale and delivery of Hermann Sewerin GmbH are not extended by the above.

- This product may only be used after the operating instructions have been read and understood.
- This product was developed for qualified skilled personnel in public utility companies. The device must only be commissioned after respective introduction.
- This product may only be used for its designated purpose.
- This product is destined for industrial and commercial applications.
- Repair work may only be carried out by appropriately trained persons.
- Changes and modifications to the product may only be carried out with the consent of Hermann Sewerin GmbH. Unauthorised modifications to the product render the warranty of the producer null and void.
- Only accessories from Hermann Sewerin GmbH may be used with this product
- Only replacement parts approved by Hermann Sewerin GmbH must be used for repairs.
- We reserve the right to make technical modifications in the interests of further development.

Please comply with general safety rules in addition to these instructions!

### 1.2 Intended use

**EL** is an electronic locating device for locating electrically conductive, underground lines.

**EL** may be used for the following purposes:

- Locating and tracking of lines
  - passive location if the necessary alternating current already applies
  - active location if the required alternating current is generated by means of generators
- Determination of depth of the line
- Measurement of the current strength in the line

The **AF 100** is a combination instrument for pipeline location and water leak detection

The standard version of the device does not comprise the following functions:

- analog output for the Pearson method
- Battery-powered device

If you need a version that includes one of them, please contact the manufacturer or distribution partner direct.

Functions that are not available with your **AF 100/EL** cannot be activated.



**Note:**

Descriptions used in this operating instructions refer to the **EL** and **AF 100** versions.

This operating instructions describes the functions of software version 8.X. Future changes are subject to modification!

### 1.3 General notes

- In order to ensure the correct functioning of the devices, the following requirements must be complied with:
  - Devices must not be dipped or immersed.
  - Display and keyboard must not be scratched.
  - Devices must not be dropped.
  - Devices must not be used as supports.
- The allowed operating temperature range is  $-10\text{ °C} - +50\text{ °C}$ .
- The allowed storage temperature is  $-25\text{ °C} - +70\text{ °C}$ .
- If additional devices are used (e.g. generators), the corresponding operating manuals must be complied with.

## 2 Function description

### 2.1 Pipeline location (EL/AF 100 only)

The **EL** and **AF 100** are instruments for the location of all electrically conductive underground lines, hence-forth called „lines“ for short. Together with special probes they are suitable for locating cable faults and damage to lines with cathodic protection.

Lines can be searched for electronically provided that they have an alternating current of a suitable frequency and adequate intensity flowing through them.

Using special probes connected to the **EL** or **AF 100** the magnetic field resulting from the alternating current is reconverted to current (induction). This current is then evaluated and displayed by the **EL/AF 100**.

The cases described in this operating instructions relate exclusively to the presence of a single straight line. If there are several live lines in parallel their individual magnetic fields may be superimposed to form a single resultant. This may give rise to discrepancies between the measurement results and the actual location of the line(s). However, judicious use of the various filters (reception frequencies) can often avoid such interference.

There are two basic location procedures:

#### a) Passive location

The required alternating current is already present „as a matter of course“. The **EL/AF 100** have appropriate reception frequencies for this case:

<b>Radio</b>	Underground lines act like antennas for very long wavelength radio transmitters (VLF range), resulting in a corresponding alternating current. Since the radio transmitters cannot always be received at the same intensity, under certain conditions a line may be „overlooked“.
<b>50 – 60 Hz</b>	For cables that are not only live, but also under load.
<b>100 Hz</b>	For lines with cathodic protection.

**b) Active location**

The alternating current is produced using a generator. (See the relevant operating instructions, e.g. for the generator G1.)

**2.2 Water leak detection (AF 100 only)**

The **AF 100** is used in combination with various microphones (listed in the „Accessories“ section) for the electro-acoustic detection of water-leaks.

When a pressurised pipeline develops a leak, water flows through it into the surrounding soil at high speed.

Consequence:

The pipeline material vibrates at the exit point. This vibration is transmitted by the pipe, with the result that it can be picked up even at remote contact points (valves and the like). This structure-borne noise is rendered audible by the **AF 100**.

The water jet - and the pipe, in the vicinity of the leak - also induce vibration in the soil. This is transmitted to the surface, where it can be picked up as ground-borne noise.

Even with electro-acoustic leak detection the human ear retains its importance. Suitable practice enables noises of different types and tones to be compared, and leak noise distinguished from extraneous, unrelated noise.

### 2.3 Acoustic Pipeline location (AF 100 only)

Plastic lines cannot be located by the classical electromagnetic method because they do not conduct electricity.

The acoustic method of pipeline location uses a different principle: the lines transmit mechanical vibration better than the surrounding earth. If suitable vibrations are applied to the line, they are transmitted along its length and through the earth to its surface, and can then be located there with a ground microphone and receiver with headsets according to the **water leak detection** principle. As with water leak detection, the line is in the place where the greatest intensity is found. Fibrous-cement and metallic pipes can also be located in this way.

If you wish to detect the lines acoustically, follow the operating instructions for the vibration emitter (eg, COMBIPHON). Proceed as with for water leak detection. The **AF 100** also offers an additional mode to assist in detecting lines (see section 5.2.1).

## 3 Use

### 3.1 Switching on and off



- Plug a probe into the appropriate input .  
Antenna A3-S: **input 1**  
other probes: **input 2**
- A brief signal tone sounds.
- The software version appears in the display.
- The charge status of the rechargeable batteries appears in the display.
- The type of probe plugged in is automatically determined.
- The probe type briefly appears in the display. If the probe type is not automatically identified it can be selected manually (see section 3.1.1).
- If a microphone has been plugged in, the bandpass currently set for the frequency filter is briefly displayed.



- The layout of the display depends on the used probe. The measurement process may be started.
- To switch off, unplug the probe from the input.

### 3.1.1 Manual probe selection

If the probe is not automatically identified (if it is an old model, for example), it can be selected manually:

**EL**



- Hold down the depth key.
- Plug in the probe.
- The „>“ symbol appears on the left of the bottom text line and the name of the probe that can be selected, e.g. „FS3“ in the middle.

- Pressing the cursor keys switches between possible probes.
- Pressing the magnifying-glass key displays the selected probe.

**AF 100**



- Hold down the microphone key.
- Plug in the probe.



- The „>“ symbol appears on the left of the bottom text line and the name of the probe that can be selected, e.g. „FS3“ in the middle.
- Pressing the cursor keys switches between possible probes.
- Pressing the magnifying-glass key displays the selected probe.

### 3.2 Adjusting the display contrast



The display contrast can be adjusted as follows:

- Hold down the light key.
- Press the cursor-down key to reduce the contrast.
- Press the cursor-up key to increase the contrast.

### 3.3 Charging equipment



When fully charged the instruments have a maximum operating time of approx. 12 hours.

To charge an instrument you need the docking station HS 1,2 A (see fig.), which can be used either in the workshop or in the emergency vehicle.

The docking station has the following sockets on its side:

- AC/DC adapter M4, 100 – 240 V~
- Vehicle cable M4 for 12 V or 24 V

### 3.4 Charging



**Note:**

Charging the accumulator only within temperature rang 0 – 45 °C

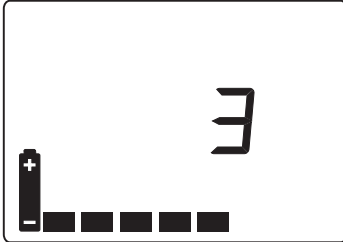

- Switch off the instrument and plug it into the docking station. The following (or similar) appears in the display:
- The instrument now has 5 operating hours (= 5 bars) left. It will take another 3 hours to be fully charged. The actual operating time depends on the accumulators' condition (age...) and operation (light, volume...). Charging time takes max. 4 hours.
- When it is fully charged all the bars appear and the number display disappears.
- You can leave the instrument in the docking station until you need it again.

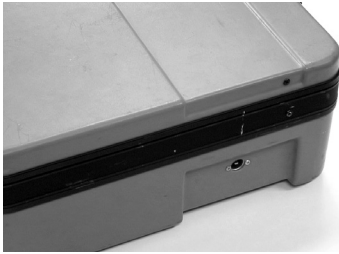

If you have a case for your **EL/AF 100**, it can be charged inside.

- Connect cable to the docking station inside the case.
- Connect the plug-in AC/DC adapter M4 or vehicle cable M4 to socket 2.



### 3.4.1 Self-discharge

If the instrument is not placed in the docking station HS 1,2A when switched off the NiMH-accumulator will self-discharge, which is considered when displaying the remaining operating time.

After no more than 30 days the instrument will indicate zero operating hours, and it must be recharged.

### 3.5 Connecting the headphones



**EL/AF 100** are fitted with a **speaker (1)**.

Such produces the confirmation and alarm signals. There is, furthermore, a specific tone for pipeline location.

During **water leak detection** no leak noise is emitted over the speaker: **headphones** must be used. Switching from speakers to headphones:



- Plug the headphones jack-plug into **socket 2**.  
The speaker is switched off automatically; sound is output to the headphones.
- When the headphones are unplugged the sound is once more output to the speaker.

## 4 Pipeline location (EL/AF 100)

### 4.1 Displays

#### 4.1.1 Positional display

The positional display is only available if the antenna A3-S (and the previous antenna A3 version) is used but not with other usable probes. The two direction arrows indicate in which position you and the antenna are compared to the line.

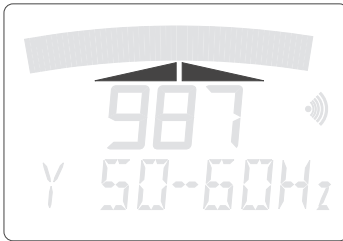

**both arrows displayed**

line directly beneath the antenna

**left arrow displayed only**

line on the left of antenna

**right arrow displayed only**

line on the right of antenna

#### 4.1.2 Analog display

The analog display indicates a deflection near the line. It shows, depending on the set method, via the line a minimum (minimum-method) or a maximum (maximum-method).

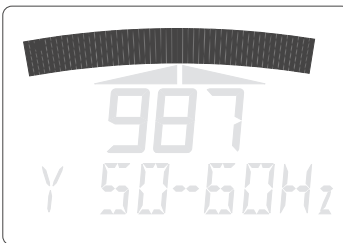

**Respective volume of the acoustic signals**

**Headphones**

The pitch of the audible signal corresponds to the deflection of the analogue display.

**Speakers**

**Minimum-method:** loudness corresponds to the analog display.

**Maximum-method:** time difference between the tones changes:

- loud response > close to line > short spacing between tones
- quiet response > further from line > greater spacing between tones

#### 4.1.3 Frequency display



The frequency display indicates the measurement range set. Possible displays are:

**radio** (20 kHz), **50 – 60 Hz**, **100 Hz, A** (42 kHz), **B** (9,95 kHz), **C** (1,1 kHz), **PIG**

#### 4.1.4 Digital display

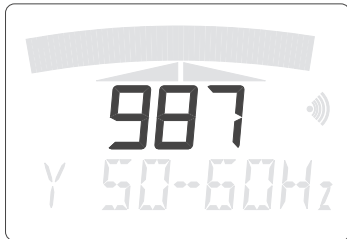

The digital display indicates **field strength** for pipeline location.

#### 4.1.5 Battery status

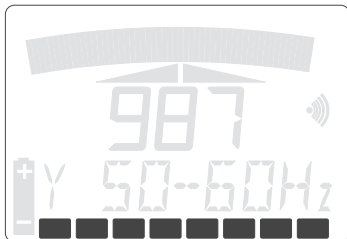

The bars in the display indicate charging status. Each bar stands for one more operating hour. For example, if 5 bars are visible the remaining charge is sufficient for another 5 hours' operation.

#### 4.1.6 Battery warning

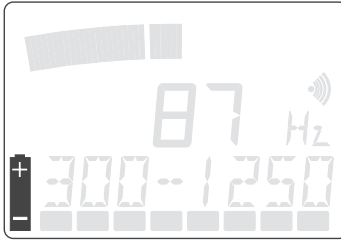

When the battery-warning symbol appears in the display, the remaining charge is only sufficient for another 15 minutes or so. In case the accumulator volume drops further, the instrument automatically switches off to protect the accumulator.

#### 4.1.7 Speaker symbol

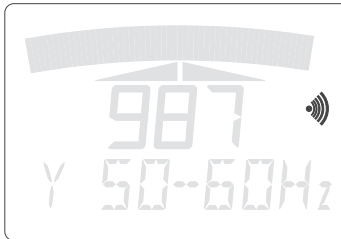

The speaker symbol appears in the display when direct acoustic output is activated.



## 4.2 Key functions

### 4.2.1 Frequency selection (ABC key)



Repeatedly pressing the ABC key steps through the individual frequency ranges.



**Note:**

If the generator is already active when the receiver is switched on and if you are within the area covered by the reception range, the receiver will automatically set the used frequencies. The reception range is located close to the generators and/or the coupled line.

The last used method is saved for each frequency range. This information is retained even after switching off the **EL/AF 100**.

#### **Passive location**

The alternating current necessary for pipeline location is already present. Reception frequencies: radio, 50 – 60 Hz and 100 Hz.

#### **Active location**

The alternating current is “actively” generated by a generator. Frequencies A, B, C.

See the operating instructions of the relevant generator, e.g. the generator G1/G2!

Together with the FS20 probe, the frequency PIG = 21.5Hz is also available for some pig transmitters.

## Reception frequencies

Displayed	EL and AF 100	Area of application, correct frequency, note
PIG	S	Pig locating, currently only with FS 20 and FS 3A
50 – 60 Hz	S	Power supply
100 Hz	S	Cathodic protection
A	S	41660 Hz
B	S	9950 Hz
Bs	S	Older generators, 9950Hz, 9941Hz, "2nd level" to main frequency; select B and then hold down ABC key.
C	S	1100 Hz
Cs	S	Older generators, 1105Hz, 1090Hz, 1100Hz, „2nd level“ to main frequency; select C and then hold down ABC key.
Radio	S	Very Low Frequency. It is not possible to change over to the minimum method.
F	O	480 Hz, 491 Hz
G	O	982 Hz
H	O	9820 Hz, 9800 Hz
I	O	33000 Hz
K	O	39200 Hz

S Standard package

N Not possible

O Optionally possible, number restricted if applicable

### 4.2.1.1 Direct acoustic output

The direct acoustic output does not work with the built-in speaker. Therefore **headphones** are essential.

In direct acoustic output the 50 – 60 Hz or 100 Hz frequency of the line is output direct to the headphones, i.e. you hear a 50 – 60 Hz or 100 Hz tone through them.

If the direct playback of audible signals is not enabled, you will always hear a signal on the headphones. The pitch of this signal depends on the distance to the line.

- Insert the phone jack of the headphones in the device's connector.
- Repeatedly press the ABC key until the required frequency (50 – 60 Hz or 100 Hz) is selected.
- Press and hold down the ABC key until a clearance tone sounds.

The speaker symbol appears in the display. Direct acoustic output is activated.

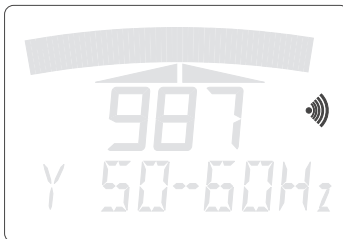

#### 4.2.2 Depth key

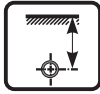

With the antenna A3-S the depth key is used to measure the depth of a line and the current strength in the conductor.

#### 4.2.3 Cursor keys



The cursor keys are used to adjust the **volume** of the headphones or the speaker. Special functions may also be selected.

#### 4.2.4 Magnifying-glass key



#### What happens on pressing the magnifying-glass key?

The magnifying-glass key is for adjusting the analogue display, acoustic output (speaker, headphones) and probe sensitivity.

The magnifying-glass key is especially important since only with correct adjustment can the desired change be identified when a line is crossed.

#### When is the magnifying-glass key to be pressed?

When the indication (analogue display, digital display, acoustic signal) during use

- does not change or changes very little. Especially when the expectation is for the indication to change
- is constantly in the lower or upper section
- on turning on the detector
- on any change to the frequency
- with each change of the method (minimum-maximum method)

### **What do I do?**

Turn on the detector. A deflection is shown on the analogue display. Animated bars appear in the lower section of the display.

Now press the magnifying-glass key. After a short time the analogue display adjusts to half the maximum value (half the indication), the sound is adjusted to a mean value and the animated bars disappear.

### **How do I know if the detector has been set too sensitively and what should I then do?**

The detector has been set too sensitively when you cross a presumed line and the analogue display reveals the maximum value (100 % of the analogue display).

Press the magnifying-glass key where the indicator rises and 100 % is shown. After a short time the analogue display adjusts to half the maximum value (half the indication) and the sound is adjusted to a mean value.

Now go back until the display only shows approx. 10 – 20 % and cross over again. Should the indication continue to be set too sensitively on again crossing the line, then this procedure is to be repeated.

### **How do I know if the detector has been set too insensitively and what should I then do?**

The detector has been set too insensitively when you cross a presumed line and the analogue display **only** reveals a small value e.g. under 30 % across a large area. Then press the magnifying-glass key.

Now go back until the display again reveals a small value and cross over again. Should the indication continue to be set too insensitively on again crossing the line, then this procedure is to be repeated.

### **How can I set the display to a more sensitive or more insensitive level?**

To increase the sensitivity level of the display: Go to a measuring point in the field at which the analogue display indicates a value significantly below 50%. Then press the magnifying-glass key.

To decrease the **sensitivity level** of the display: Go to a measuring point in the field at which the analogue display indicates a value significantly above 50%. Then press the magnifying-glass key.

### **Special characteristic with setting “100 Hz”**

If the frequency setting 100 Hz is selected, the analogue display will be set to the maximum value and not to 50% – when the magnifying-glass key is pressed. In addition, also the digital display is set to the maximum value (100.0).

This peculiarity applies only if the A3-S is used with the maximum-method.

### **„OVERFLOW“**

If “OVERFLOW” is indicated on the display, you are approaching a strong electromagnetic field.

- Move away from the generator.
- Move the antenna away from the line if you are currently locating objects.
- Reduce the power level of the generator.
- Press the magnifying-glass key.

### Other probes

If you are using a different probe than the antenna A3-S, the analog display must always be adjusted manually.

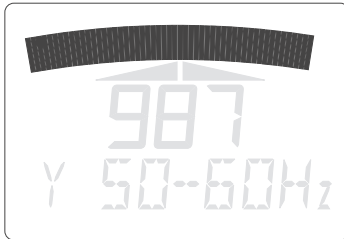

(EL)



(AF 100)

### Manual adjustment (procedure)

- Start a measurement with any probe. The analog display indicates a reading.
- If this deflection is significantly **lower (higher)** than approx. 75% of the maximum deflection possible, try to find a reading point within the territory, at which the deflection is, if possible, **minor (maximum full deflection)**.
- Press the magnifying-glass key.
- Continue measurement.

OR

Repeat the manual adjustment (as often as you like), in order to further optimise the deflection of the analog display.

## 4.3 Probe overview

### 4.3.1 Antenna A3-S



The antenna A3-S is used to locate underground lines and determine their depth. These lines may be live electric cables or other metal lines such as water pipes.

Three coils are combined in the antenna A3-S. Due to this, it is the probe with the widest range of application.

### 4.3.2 Search coil SK3



The search coil SK3 is used to locate cables in a bundle of cables and to find lines covered by plaster.

The 1.1 kHz (-C- frequency) and 10 kHz (-B-frequency) can be received.

### 4.3.3 Search coil FS20



The search coil FS20 is specially designed for low frequencies (20 Hz – 100 Hz). It is used particularly to locate lines with cathodic protection.



#### 4.3.4 Cable clamps AZ5



The cable clamp AZ5 (50 mm in diameter respectively) is used to locate individual cables among a large number of other identical or different cables.

The cable clamp can also be used to transmit a signal along individual lines (see generator operating instructions).

#### 4.3.5 Search coil FS3 A



The search coil FS3 A is used to locate underground lines.

The search coil proper of the FS3 A can be operated in 3 different positions: vertical, at an angle of 45° and horizontal. This is useful in determining the depth of a line.

The 1.1 kHz (-C- frequency) and 10 kHz (-B- frequency) reception frequencies can be received.

#### 4.3.6 Other probes

The use of other probes (e.g. the step-voltage probe EL02) is covered in separate operating manuals. For more detailed information please contact service.

## 4.4 Antenna A3-S



### Note:

Comply with the quick reference guide (sticker) on the antenna A3-S.



**Prerequisite** for the use of the antenna A3-S is that your **FERROPHON/AQUAPHON** relies on the **software version 5.4** (or higher).

Inside the A3-S three different coils are combined. To achieve best possible results it is of significant importance to hold the antenna in a **vertical** position. The **cable points away from the operator's body**.

### 4.4.1 Displays

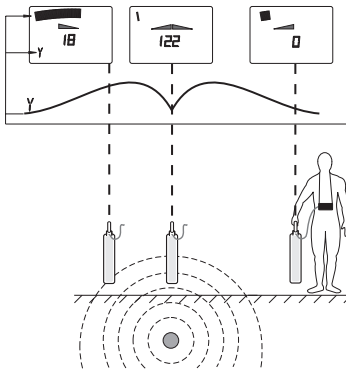

The graphic shows how the display changes when you cross a line with the antenna A3-S.

The analog display and the diagram show what happens when the minimum-method is set.

### 4.4.2 Methods

Two different methods can be used with the antenna A3-S. (For more detailed descriptions of the methods see table on following page).

You can see which method is selected by the symbol in the lower left of the display (Shown in left example: minimum method).

The crossing of a line results in a respectively **different run of the analog display** depending on the selected method.

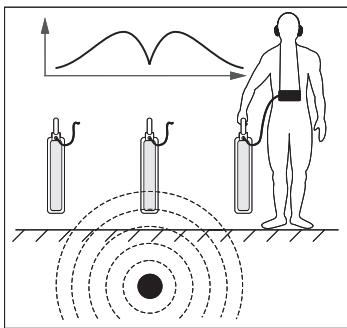

Minimum-Method

- **Minimum-Method**

With the minimum-method the analog display initially rises steeply when approaching a line. But directly above the line it is at a minimum.

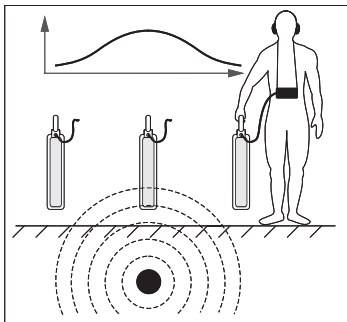

Maximum-Method

- **Maximum-Method**

With the **maximum-method** the analog display rises at a constant rate when approaching the line, reaching its maximum directly above the line.



**Change of method**

- Hold down the light key and press simultaneously the magnifying-glass key.

**Methods of pipeline location (overview)**

Method	Maximum-Method	Minimum-Method
<b>Use</b>	Pre-locating	Exact locating, tracking lines
<b>Holding direction</b> (of antenna to line)		
<b>Displayed curve</b> - Analog display		
	- Digital display	Maximum directly above the line if A3-S is in recommended holding direction
<b>Symbol in comment line</b>		
<b>Acoustic signal</b> - Loudspeaker	Impulses of same volume	Permanent tone low/high volume
- Headphones	Changing the pitch	

### 4.4.3 Pipeline location

The antenna A3-S is used to locate underground lines and determine their depth. These lines may be live electric cables or other metal lines such as water pipes.

Non-metallic lines may only be located using the **EL/AF 100** if a metal wire was added when laying the line.

If no wire is present the location of non-metallic lines requires a glass-fibre probe system (GFS / GSK). This system consists of a glasfibre rod with a metal wire embedded in it and a mini pig transmitter. The glasfibre rod is passed along the line and can then be located with the **EL/AF 100**. The mini pig transmitter serves to determine the end position of the glasfibre rod.

### 4.4.4 Locating lines



#### Caution!

Also comply with the generator's operating instructions when locating lines with such.

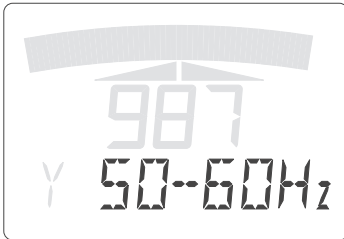

- Keep pressing the ABC key until a suitable reception range is set, e.g.:
  - 50 – 60 Hz for live electric cables or
  - A, B or C for lines into which a generator is transmitting a signal.
- Select a suitable method (see section 4.4.2, Table).

To switch methods, hold down the illuminated key and press the magnifying-glass key.

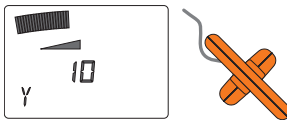

- Press the magnifying-glass key to adapt the deflection of the analogue display, the playback functions edition (loudspeaker, headphones) and the sensitivity level of the detector.
- Traverse the ground with the antenna A3-S. While doing so, watch the analog display and listen to the audio signal. The display will deflect when near lines. Reprress the magnifying-glass key, if necessary (see chapter 4.2.4).

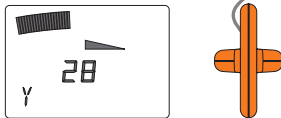

#### Pipeline location on the basis of minimum method (practical example)

The left and/or the right arrow is lit. The analog display is deflecting.



- Rotate the antenna A3-S so that the deflection of the digital display is as wide as possible. The arrows now indicate the position of the line. However, it is very likely that you are as yet not directly situated above the line.
- Observe the arrows' indication. Move laterally with the direction of the indicated arrow (left arrow:  move laterally in left direction, right arrow:  move laterally in right direction)

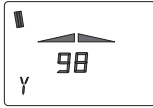

As soon as you are situated directly above the line, a double arrow will be shown. The analog display and the digital display (field strength) show simultaneously and respectively a minimum and a maximum value.



**Note:**

In order to exactly locate a line, the cable emerging from the antenna A3-S must be positioned away from the body, i.e. in walking direction.

**4.4.5 Special features when using a generator**

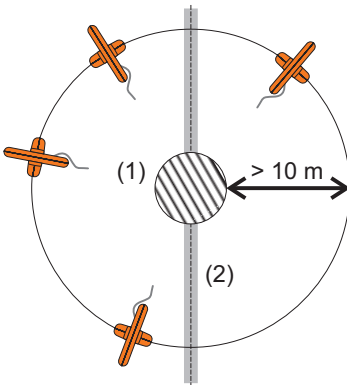

To locate a point on the line, circle the **generator (1)** at a **distance of at least 10 metres**. Be careful to hold the antenna A3-S as shown in the illustration.

As soon as you are above the **line 2** a double arrow appears in the display and the analog display is at a minimum.

#### 4.4.6 Following a line



**Note:**

The best method for following the line is the minimum-method.

If the arrow in the display is not available, you will have to follow the line by watching the digital and analog display. The digital display must always have its maximum via the line.

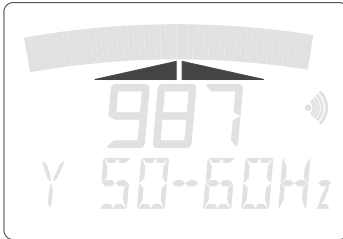

If you know or have located a point on the line you can follow it like this:

- Hold the antenna A3-S above the known position.
- Rotate the antenna until the field strength (digital display) reaches a maximum value. The display must now show a double arrow.



**Note:**

If reception is poor the double arrow is not displayed. You will have to use the digital and analog displays to locate the line.

- Move slowly forwards with the antenna A3-S. As long as you are above the line the double arrow is displayed. If only one arrow is displayed, search for the line in the direction it indicates until the other one reappears.



4.4.7 Depth measurement



**Note:**

Depth measurement with the radio frequency range is very inexact. Some other frequency should be used if possible.

The value determined during depth measurement is the distance between the lower edge of the antenna A3-S and the centre of the line.



- Hold the antenna A3-S vertically in an **exact position above the line**. The lower edge of the antenna must touch the ground.
- Press the depth key.  
The depth of the line and the current strength in the conductor in mA appear in the display.
- Conduct a second measurement for verifying the value. In order to do so, lift the A3-S antenna as far as you can do so holding it comfortably (lower edge approx. 30 cm above ground)
- Press depth key once again.  
The value now displayed must be higher than the value of the first measurement while such difference must represent the distance difference after the antenna was lifted.

The following **measuring tolerances** may be assumed for a single straight line:

Depth of the line [m]	Tolerance [m]
0	0.1
1	0.1
3	0.3

Please note in any case the following notes when evaluating the determined value.



**Notes:**

- Magnetic field overlap where lines curve or branch and if there are other lines nearby. This renders readings useless !
- If the magnetic field is very weak, the depth cannot be determined. The display will then show: **0.0 m** (flashing).
- If the line is very deep, **8.0 m** (flashing) appears in the display.
- When working in shafts you are generally recommended to check depth readings by carrying out repeated measurements.
- You can identify insulation faults and branch points by comparing the current strength in mA displayed at various points along the line.
- The values displayed are relatively accurate with respect to individual measurements, but the actual, absolute current flow may deviate more radically .

### 4.5 Use with non-metallic lines

#### 4.5.1 General information on the use with non-metallic lines

Non-metallic lines may only be located by means of the **EL/AF 100** if a cable or location tape was added when laying the line. Otherwise a glass-fibre probe system (e.g. GFS/GSK) is required for localising non-metallic lines.

The glass-fibre probe system comprises a glass-fibre rod and a mini pig transmitter.

- A copper strand is embedded in the glass-fibre rod so that it can be localised by the **EL/AF 100** device.
- The mini pig transmitter is a battery-driven transmitter for determining the end position of the glass-fibre rod.

Together with the connected mini pig transmitter, the glass-fibre rod is inserted in the line. The position and depth of non-metallic lines is indirectly determined by not localising the line itself but the mini pig transmitter and/or the glass-fibre rod.



**Note:**

Please note the respective operating instructions when using the glass-fibre probe system.

You must be familiar with the behaviour of the show display function and the acoustic signals for locating lines by means of mini pig transmitters.

The mini pig transmitter's analog display will react differently for the minimum method than for the pipeline location.

The electromagnetic field of the mini pig transmitter causes so-called **secondary minimums**. At these position, the analog display also shows a minimum. There is, furthermore, a change of the positional display (arrows).

The digital display and the acoustic signals correspond to the pipeline location (see chap. 4.1).

**Maximum-Method:**

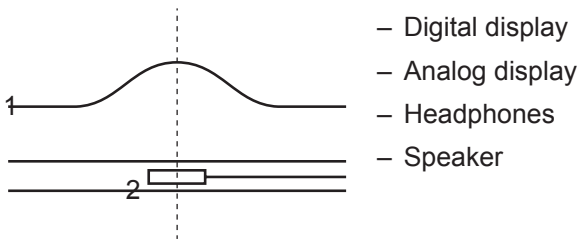

**Minimum-Method:**

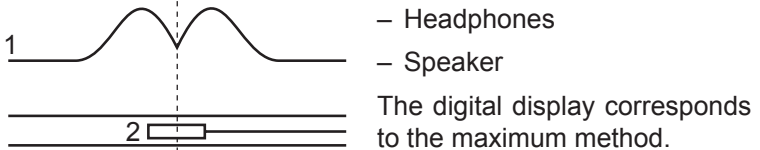
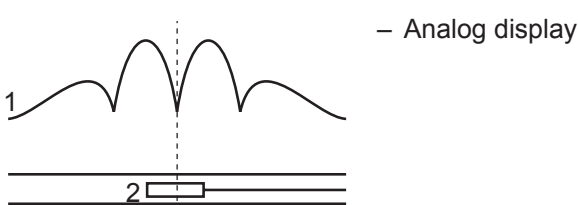

- 1 Progress of signals
- 2 Side view of line with mini pig transmitter

### 4.5.2 Locating the of the mini pig transmitter



**Notes:**

The positional display only provides correct results when positioned directly above the mini pig transmitter. Such may be disregarded when locating.

The glass-fibre rod must not receive signals when locating is in progress. The generator must be switched off.

In order to find the mini pig transmitter, the approximate run of the line must be known.

The mini pig transmitter must be in a horizontal position to achieve measurement results as correct as possible.



(EL)



(AF 100)

- Activate the mini pig transmitter.
- Switch on the **EL/AF 100**.
- Set the frequency, which is emitted by the mini pig transmitter, using the ABC key.
- You can select the desired method through the following key combination:

Hold the light key down and simultaneously press the magnifying-glass key. Pay attention to chapter 4.2.4.

- Hold the device so that you can read the display and that the antenna is in a position perpendicular to the ground.

**Tip:**

To familiarise yourself with the properties of the display on the EL/AF 100, you can simulate detection of the mini pig transmitter. Place the activated mini pig transmitter on the ground (caution: not on concrete with steel rod mats for example). Move the aerial over the mini pig transmitter as shown in the following diagrams. The distance between the bottom of the aerial and the mini pig transmitter should be 0.5 – 1.0 m to ensure that any change to the display is clearly visible (audible).

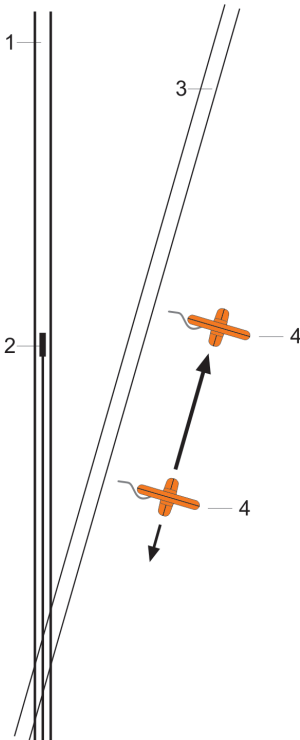

- 4 Antenna A3-S
- 1 Actual line
- 2 Mini pig transmitter
- 3 Assumed line

**Step 1:****Determination of the approximate position of the mini pig transmitter within the line's run**

- Hold the antenna A3-S as shown in the direction of the assumed line run. When doing so, the antenna is in a position parallel to the assumed line run.
- Slowly perambulate the area parallel to the assumed line run in both directions indicated by the arrows.
- At first, consider the digital display only.
- Stop in the area in which the value of the digital display is a maximum.

If the suspected piping does not match the actual piping, the value of the digital display can be further increased in the next step.

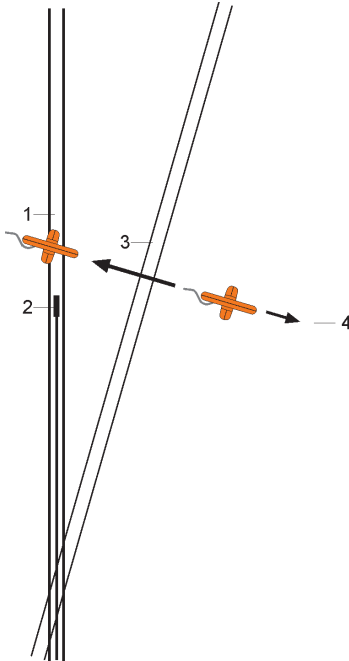

- 1 Actual line
- 2 Mini pig transmitter
- 3 Assumed line
- 4 Antenna A3-S

**Step 2:**

**Approaching the mini pig transmitter**

- Slowly perambulate the area parallel to the assumed line run in the both directions indicated by the arrows. I.e. the search motion direction is in a 90° angle to the direction of the previous tracking motion.
- Move the antenna A3-S in both directions indicated by the arrows until you find the area in which the value of the digital display is a maximum.
- Stop in the area in which the value of the digital display is a maximum.

You are probably situated above the line but not above the mini pig transmitter

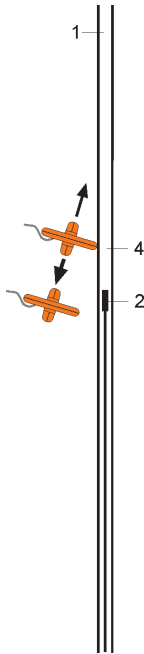

- 1 Actual line
- 2 Mini pig transmitter
- 4 Antenna A3-S

### Step 3:

#### Determination of the mini pig transmitter's exact position within the line run

- Move the antenna A3-S slowly in a 90° angle with regard to the direction of the previous tracking motion in both directions indicated by the arrows.
- Stop at the position at which the value of the digital display is a maximum.

The antenna A3-S is situated exactly above the mini pig transmitter if the digital display shows a maximum.

The user should be able to work quickly and practically on a trial and error basis (see tip on page 37).



### 4.5.3 Depth measurement of the mini pig transmitter

The depth of a non-metallic line can only be determined directly above the mini pig transmitter.

- Determining the position of the mini pig transmitter (see chap. 4.5.2)
- Hold the antenna in an upright position directly above the mini pig transmitter. The lower edge of the antenna must touch the ground.
- Press the depth key.
- Press one of the two arrow keys in order to access the **mini pig transmitter depth determination** mode.

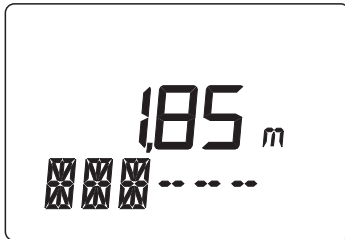
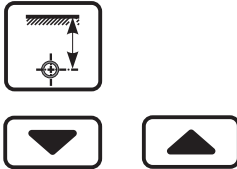

The depth will be displayed in metres.

Repeated pressing of the cursor keys allows for switching between the two modes of **depth determination** and **depth determination of mini pig transmitter**.



**Note:**

Different factors may result in deviations between the displayed depth und actual depth of the mini pig transmitter, e.g. conductive objects or lines. For digging works, it is advisable to re-establish the measured depth by repeated measurement within the excavation itself.

## 4.6 Special aspects in practical work

### 4.6.1 Inaccuracies of measurement

In order to locate a line, a sufficiently strong current is required within the line. If the magnetic field is too weak, the displayed results do not allow for clear evaluation. With a weak magnetic field, the digital display shows a field strength value of less than approx. 10 ... 20.

Several factors may influence the measurement accuracy, e.g.

- moisture of soil,
- diameter of pipe,
- thickness of insulation.

If the magnetic field is deformed, clear locating is not always possible, e.g.

- if foreign lines cross the line to be located,
- in case of junctions or curves.

### Advice on optimising pipeline location

- Use headphones.
- Adjust the analog display manually.
- Vary the transmitter frequency.
- If necessary, modify the way the generator is coupled (galvanically and/or inductively).
- Improve contact with ground, for example by dampening the earthing spike.

### 4.6.2 Distortions of the field

Metallic materials or metallic lines in a parallel position may cause distortions of the field. Field distortions may cause a lateral shift of the displayed line results.

#### **Advice on optimising in case of field distortions:**

- Check whether the selected coupling method of the generator is suitable.
- Use lowest amounts of current possible.
- Use lowest frequencies possible.

### 4.6.3 Locating cable faults

Under certain conditions, it is possible to locate cable faults. Success substantially depends on the fault type and the fault's resistance. The following two extreme cases are favourable:

- short circuit (zero fault resistance)
- cable rupture (infinite fault resistance)

Towards the location of fault, the current intensity and, thus, the field strength signal continuously decrease so that the fault's exact location cannot be determined. In order to improve the accuracy of measurement, locating must be carried out from both ends of the cable.

Through the suitable sending of signals to the faulty cable, the cable fault can be located through disturbances within the structure of the magnetic field. There are several causes for the type of disturbance. A few examples are given in the following:

#### **Short circuit between two or more cores**

When the generator is galvanically connected to two of the short-circuited cores (preferably at low frequency), the location of the fault is indicated by a sudden drop in field strength

#### **Earth fault in one core**

If there is an earth or sheathing fault in the core the generator is galvanically connected. The location of the fault is indicated by a sudden drop in field strength (preferably at low frequency).

### **Disruptions in strand**

In order to determine disruptions in strands or ruptures of the entire cable, the generator must also be connected galvanically.

- In case of rupture of a single strand:  
Connection to the strand and all other strands connected in parallel.
- In case of rupture of the entire cable:  
Connection to all strands connected in parallel and to cable sheath. The strands must be combined so that the highest possible capacity is generated.

### **Advice on locating cable faults:**

- Determine the location of the fault from both ends of the cable.
- If necessary, cause a short-circuit using a burn-in transformer.
- If the frequency setting 100 Hz is selected, the analogue display will be set to the maximum value and not to 50% – when the magnifying-glass key is pressed. In addition, also the digital display is set to the maximum value (100.0). This ensures a better indication of the (protection) current drop at the error location.
- This peculiarity applies only if the A3-S is used with the maximum method.

#### 4.7 Cable clamp AZ5



The cable clamp is an auxiliary instrument used to pick out one particular cable from a bundle. A cable cannot be picked out unless it is an electric-power cable under load or a generator is transmitting a signal into it

The cable clamp can also be used to transmit signals into individual lines (see generator operating instructions).



#### Caution: high tension !

Closing the clamps round individual power cables cores under heavy load can induce high voltages in them that are sufficient to electrocute the user and/or destroy the **EL/AF 100**. Current strength in the cables must not exceed 300 A.

#### Locating a single cable in a bundle

All cables to be considered must be individually checked one after the other, i. e. must be encompassed in the cable clamp. A maximum results for the cable which is receiving signals form the generator.



- Connect these cable clamps to the generator (see generator operating instructions).
- Close the Cable clamp AZ5 round the cable.
- Connect a second cable clamp to the **EL / AF 100** and encompass the cable to be checked.
- Use the ABC key on the **EL/AF 100** to set the same frequency as the generator.
- Check the next cable in the same way.

### 4.8 Search coil SK3



The search coil SK3 is a small, hand-operated probe for the selection of individual cables in a bundle and the location of lines covered by plaster.

The search coil SK3 is used to find lines into which a generator signal at the 1.1 kHz or 10 kHz frequencies is being transmitted.

- Transmit a generator signal into the line.
- Connect the search coil SK3 to the **EL/AF 100**.
- Use the ABC key to set the same frequency as the generator.
- Use the search coil to test the cable bundle or the plaster-covered area of the concealed line.

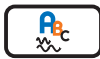

### 4.9 Search coil FS20



The search coil FS20 is designed for low frequencies (20 Hz – 100 Hz), to which it is highly sensitive. It is thus particularly suitable for the location of lines with cathodic protection.

- Connect the search coil FS20 to the **EL/AF 100**.
- Check the area under test with the search coil.

#### 4.10 Search coil FS3 A



The search coil FS3 A is used to find lines into which a generator signal at the 1.1 kHz and 10 kHz frequencies is being transmitted.

- Connect the search coil FS3 A to the **EL/AF 100**.
- Check the area under test with the search coil.

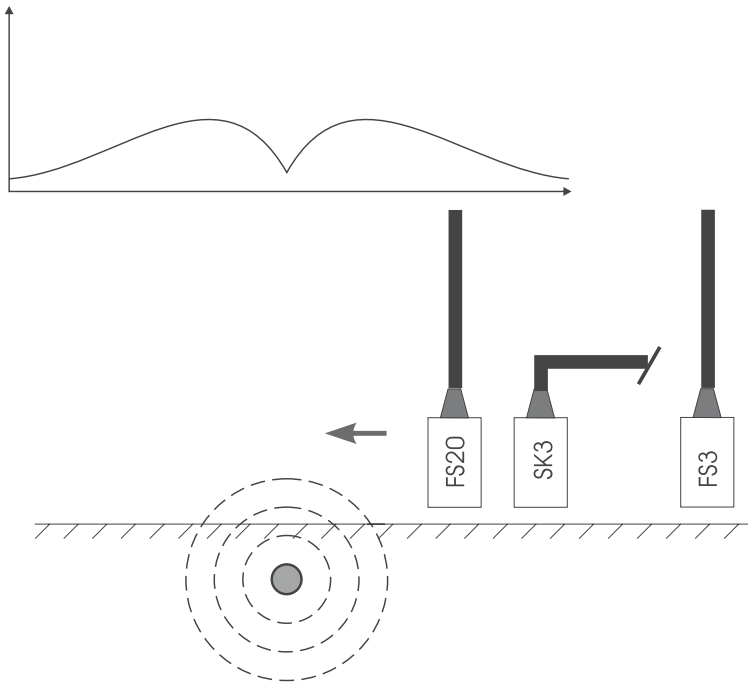

The diagram shows the response of the analog and field-strength displays when the line is crossed in the direction of the arrow with an FS20, SK3 or FS3 A probe.



#### 4.10.1 Depth determination with the search coil FS3 A

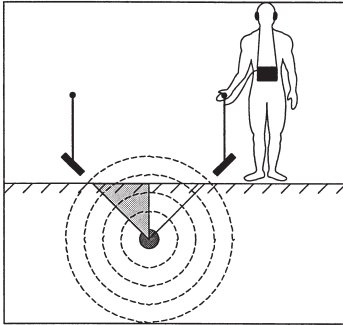

The search coil FS3 A can also be used for depth determination, provided that one point on the line and its track are known.

- Connect the search coil FS3A to the **EL/AF 100**.
- Swivel the search coil to an angle of 45°.
- Move to one side of the known point on the line.
- Look for the field-strength minimum to the side of the line.
- The distance from the known point on the line to the point at which the field-strength display reaches its minimum is equal to the depth of the line.
- The result should be checked by repeating the measurement on the other side of the line.

## 5 Water leak detection (AF 100)

### 5.1 Displays

#### 5.1.1 Analog display

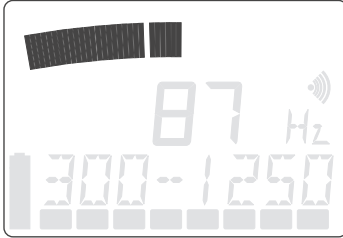

The analog display indicates the current reading.

#### 5.1.2 Digital display

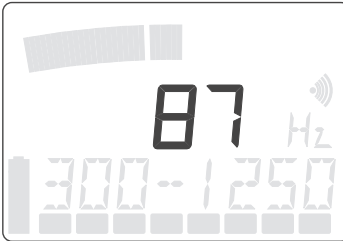

The digital display indicates the smallest value measured during a single measurement.

In the „MAX“ mode, the digital display always shows the greatest measured value. In „MAX“ mode you can switch by holding the micro key for 3 seconds.

#### 5.1.3 Small digital display

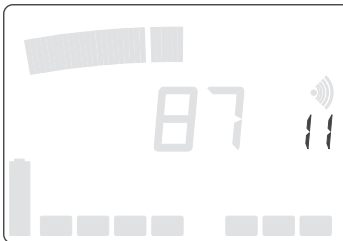

For the purposes of comparison the small digital display always indicates the precedent value measured.

### 5.1.4 Speaker symbol

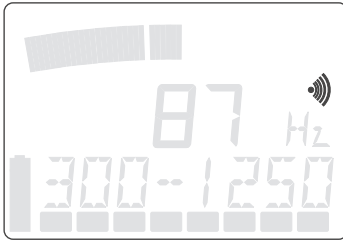

The speaker symbol indicates that the **AF 100** headphones are activated.

### 5.1.5 Volume display

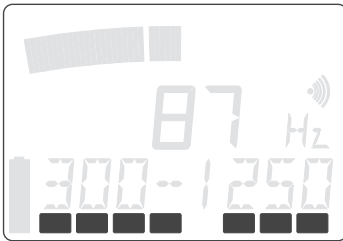

The volume display indicates the volume set. If the bar on the extreme left is shown in reverse video, the volume is low; if the bar on the extreme right is shown in reverse video, the volume is maximum.



The volume can be adjusted with the cursor keys.

### 5.1.6 Battery symbol

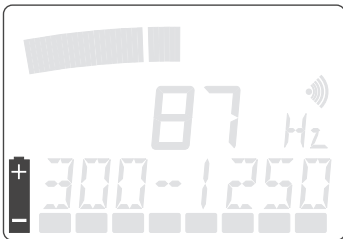

The battery symbol appears about 15 minutes before the battery runs out.

### 5.1.7 Comment line



Various possible settings and parameters are displayed in the comment line. The filter setting is shown here, for example.

### 5.1.8 Basic amplification

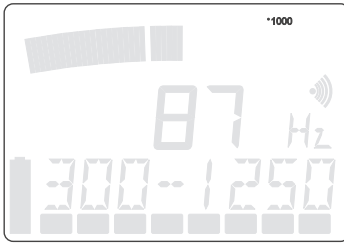

Basic amplification is useful for adapting to extreme situations. The higher the basic amplification, the louder the noise in the headphones. The values 10, 100 or 1000 appear in the display.



Basic amplification can be altered with the magnifying-glass key (see section 5.2.6).

10 = high amplification

100 = medium amplification

1000 = low amplification

## 5.2 Key functions

### 5.2.1 Microphone key



Pressing the microphone key activates the **AF 100**. Pressing it again deactivates it.

### Modus „MAX“

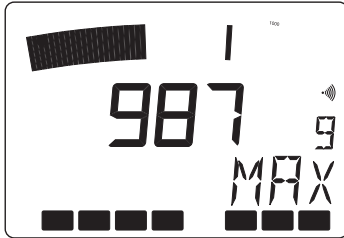

If you hold down the micro key for 3 seconds, you can switch to „MAX“mode. This mode helps with acoustic line detection. Instead of minimum values, only max values are shown in this mode.

#### 5.2.2 Gauntlet key



Pressing the gauntlet key activates the **AF 100**. Depending on the options selected in the set-up menu it is deactivated either by releasing the gauntlet key or by pressing it again.

#### 5.2.3 Hz key



The Hz key is used to alter the frequency-filter setting. The filter bandpass - which is at least 300 Hz wide - can be set anywhere between 1 Hz and 10 kHz.



Pressing both cursor keys at once resets the bandpass to its default setting, which depends on the probe.



Different leak noises can be heard best in different frequency ranges, and two people may hear the same noise differently. To optimise acoustic perception a bandpass can be set. In this case only a particular frequency range is fed to the headphones. The best setting can be found by experiment, or alternatively the **AF 100** can search for it automatically.

### Setting the frequency range manually



- Press the Hz key.  
The most recently set limits are displayed; the lower filter limit flashes.
- The cursor keys change the lower filter limit step by step.
- Press the Hz key again.  
The upper filter limit flashes.
- The cursor keys change the upper filter limit step by step.
- Press the Hz key again.  
The filter limits are saved.

### Automatic search for the best frequency range

The **AF 100** has a filter-optimisation function that automatically searches for the best frequency range. It should not be activated if there is any significant extraneous noise, and the leak noise - particularly ground-borne noise - should already be audible.



- Press the Hz key until a clearance tone sounds.
- The **AF 100** takes a „noise sample“ and analyses it. While analysis is under way the display indicates various frequency ranges. The noise produced by the filter values displayed can be heard over the headphones.
- The **AF 100** selects the frequency range in which the leak noise is especially clear.

### 5.2.4 Cursor keys



The cursor keys are used to adjust the volume of the speaker or headphones. The volume setting is shown in the display by a bar in reverse video.

### 5.2.5 Light key



The light key switches the display illumination on and off. It switches off automatically after about 2 minutes.

### 5.2.6 Magnifying-glass and on/off key



The analog display indicates the relative noise level. The display can be adapted to prevailing conditions to make a change in the display from one measurement point to another easier to detect. This adaptation switches the analog display (instantaneous value) between scale values 10, 100 and 1000 and alters basic amplification for the headphones.

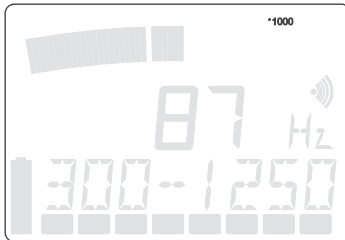

10 = high sensitivity, high amplification

100 = medium sensitivity, medium noise amplification

1000 = low sensitivity, low noise amplification

Automatic adjustment takes place to maintain the ratio between the current delayed-action value and the instantaneous value.



- Press the microphone key.  
The **AF 100** is activated.
- Press the magnifying-glass key.  
The sensitivity of the analog display is altered.
- The current sensitivity setting is shown above and to the right of the display.



### 5.3 Probe overview

#### 5.3.1 Ground microphone BO-4



The ground microphone BO-4 is used to locate leaks beneath stabilised surfaces.

#### 5.3.2 Ground microphone 3P-4



The ground microphone 3P-4 is used to locate leaks beneath unstabilised surfaces. An earth spike can be screwed onto it for use in soft ground. Its 3 feet guarantee stability at all times.

#### 5.3.3 Carrying rod H-4



The carrying rod can be used with both ground microphones. The BO-4 or 3P-4 microphone is screwed onto its lower end.

### 5.3.4 Test rod T-4

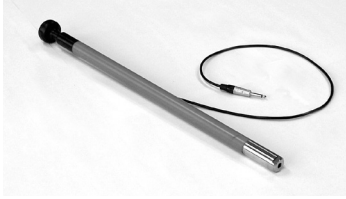

The test rod is used for preliminary leak location. The test rod is placed in contact with valves on the line under investigation.

### 5.4 Switching on and off



- Put the microphone jack-plug into socket 1 on the **AF 100**.
- The **AF 100** switches on.



- If the **AF 100** does not switch on, press the on/off key.
- One of the following displays briefly appears in the display:



for test rod or



for ground microphone or



for other microphone types.

- To switch off, unplug the probe from socket 1.

## 5.5 Sound-protection function

The **AF 100** incorporates a sound-protection function. With a sudden loud noise the sound in the headphones is immediately muffled. If the sound gets even louder the headphones are switched off. Once this noise source has ceased the **AF 100** reverts to normal operation. The sound-protection function ensures that no excessive sound pressure reaches the ears.



This headphones symbol appears in the comment line when the sound-protection function is activated.



### Caution!

Only Sewerin headphones should be used, as these are adjusted to the **AF 100**. The threshold at which the sound-protection function is triggered can be adjusted: see section 5.9 „Individual adjustments“.

## 5.6 Preliminary location

Structure-borne sound is transmitted a very long way by metallic pipes, which makes the test rod very effective for preliminary location.

- Connect the headphones to the **AF 100**.
- Connect the test rod to the **AF 100**.
- Place test rod on the first measurement point.

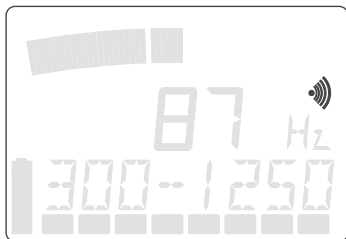

- Activate the **AF 100** with the gauntlet key or the microphone key.

A speaker symbol appears in the display during measurement.

The analog display indicates the current measurement volume.

The noise can be heard by the headphones.

During this measurement the digital display indicates the smallest value measured.

The small digital display indicates the smallest value measured during the previous measurement. (This value is 0 after first measuring.)

The smallest measured value is shown in the analog display in reverse video during the measurement.



- To deactivate the **AF 100** release the gauntlet key or press the microphone key again.

If the **AF 100** is not deactivated when the gauntlet key is released, the function of the gauntlet key has been changed (see section 5.9). In this event press the gauntlet key again.

- Place the test rod on the next measurement point and proceed exactly as described above.

The previously measured value now appears in the small digital display for the purposes of comparison.

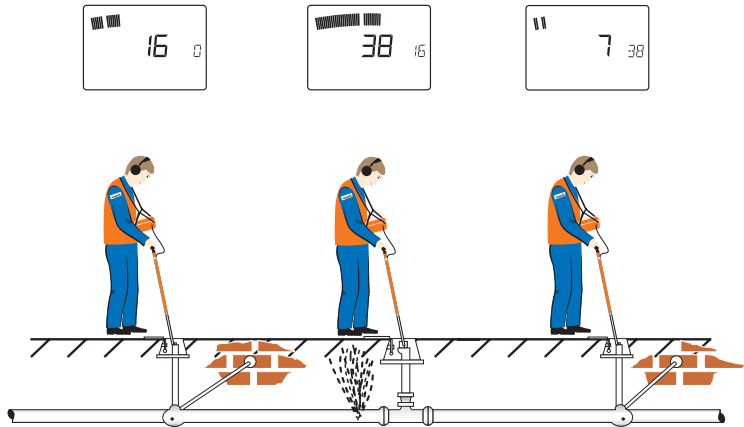

In water leak detection the display will be similar to that shown in the illustration above.

The noise is loudest near the leak and quieter further away.

**On the left:** the analog display indicates about 30%: this is the **instantaneous noise value**.

However, the analog display often fluctuates substantially because of changing ambient noise. Even a trend can be hard to recognise. This is why the large digital display (figure 16) indicates the smallest noise value measured at this point so far (**the current delayed-action value**). Even if ambient noise grows louder, this display is unaffected - while if it grows quieter the display falls further.

The figure 16 is also shown in the analog display as a segment in reverse video.

The small digital display indicates "0": as yet there is no value in memory.

**Centre:** the analog display indicates about 60%. The large digital display (figure 38) indicates a value greater than the left-hand measurement point. This is an indication that the leak is closer.

The small digital display now indicates "16": it reminds you of the result from the last measurement point (**last delayed-action value**). This makes it easier to decide whether you have not yet reached the leak or have already gone past it.

**Right:** the current delayed-action value has fallen because the leak is further away. The last delayed-action value, “38”, provides us a further comparison.

The following illustration shows how a leak noise overlaid by fluctuating extraneous noise is shown in the display.

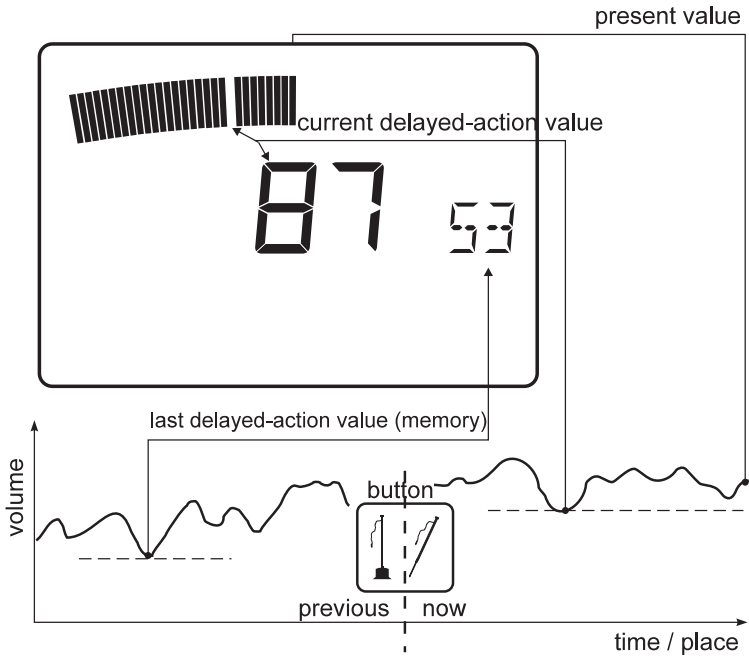

## 5.7 Pin pointing

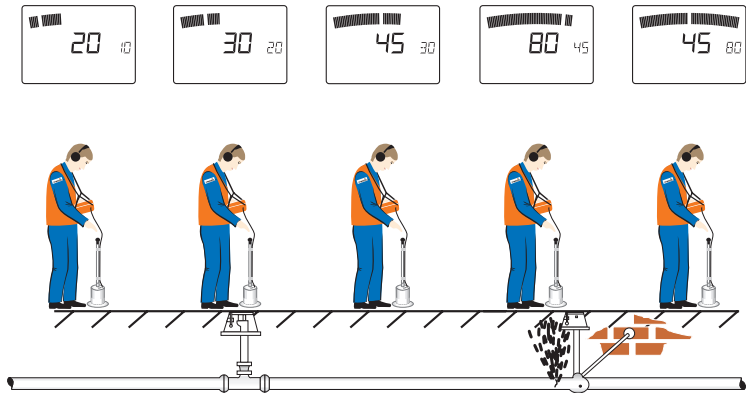

Non-metallic pipe materials do not transmit structure-borne sound as well. Therefore checking at the valves is not enough. The sections between valves must also be checked with a ground microphone.

Listening to the surface of the ground at short intervals enables the leak to be located without digging. Here, too, the **AF 100** provides a precise optical comparison of the noise intensities.

The above illustration, for example, shows how the display changes when passing a leak.



- Connect the ground microphone to the **AF 100**
- Place the microphone on the ground.
- Activate the **AF 100** with the gauntlet key or the microphone key.

A speaker symbol appears in the display during measurement.

The analog display indicates the current measurement volume.





The current noise can be heard through the headphones.

The digital display indicates the smallest value measured.

The small digital display indicates the previously-measured value. For the first measurement this value is 0.

The smallest measured value is shown in the analog display in reverse video.

- To deactivate the **AF 100** release the gauntlet key or press the microphone key again.

If the **AF 100** is not deactivated when the gauntlet key is released, the function of the gauntlet key has been changed (see section 5.9). In this event press the gauntlet key again.

- Place the ground microphone on the next measurement point and proceed exactly as described above.

The previously measured value now appears in the small digital display for the purposes of comparison.

- Use the ground microphone to check the area of the section where the leak is thought to be.

The illustration on the previous page shows an example of the display when crossing a leak.

## 5.8 Individual settings

On the **AF 100** various settings can be freely selected and permanently saved. The set-up table on the next page highlights the various possibilities.

This is a list of settings that you can alter and save. First of all please switch-on the instrument.



- Hold down the microphone key.



- Press the on/off key.  
„ELWset“ appears in the comment line.



- The microphone key calls the menu items one after another.



- The cursor-up key alters the status of the selected menu.
- After the last menu the „save“ message appears.



- The cursor-up key saves the current settings and terminates the function.



### Notes:

The ear protection function should be set to „low level“ only with low surrounding noise so that is already activated with moderate noise levels. In situations with high noise, such level should be set to option (1), factory settings, so that the ear protection function is not activated too often and, thus, cannot impair locating of a leakage. In special cases, the setting option (2) may be used. The ear protection function will then only be activated in case of very loud noise levels.

**ELW -setup table**

Menu number	Description	Condition (0)	Condition (1)	Condition (2)
1	The gauntlet key (item 1) is a key which does or does not stay down when pressed	without*	with	/
2	Quit tone on pressing button	on*	off	/
3	sound-protection function operates at	low threshold	middle threshold*	high threshold
4	Basic amplification	low	middle*	high
5	headphones switch off completely	yes*	no	/

( \* = preset status)

Example:

If the comment line contains „No 3 0“, the sound-protection function operates at the low threshold.

Basic amplification is useful for adapting to extreme situations. The higher the basic amplification, the louder the noise in the headphones at a given volume setting. Pressing the magnifying-glass key is a convenient way to alter basic amplification.

If you do not want the headphones to switch off completely when the sound-protection function is triggered by loud noises, only heavily muffled, select „switch off headphones completely: No“. This means that the user will not lose all ambient noise while using the hearing-protection headphones. An orientation, for example in traffic, is limited possible.

## 5.9 Factory settings (reset)

The factory settings (e.g. filter settings) can be restored as follows.

- Plug in a microphone jack-plug while holding down the light key.
- „Reset“ appears in the bottom text line for about 2 seconds.

## 6 Brief instruction

### 6.1 Brief instruction on pipeline location

#### Locating lines

- Keep pressing the ABC key until a suitable reception range is set, e.g.
  - 50 – 60 Hz for live electric cables
  - A, B or C for lines into which a generator is transmitting a signal.
- Select a suitable method (see section 4.4.2, Table). To switch methods, hold down the illuminated key and press the magnifying-glass key.
- Cross the area carrying the antenna A3-S. In doing so, watch the analog display and listen to the audio signal. The displayed values will deflect in the proximity of lines.

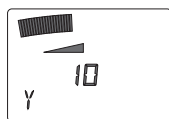

#### Line locating using the minimum method (concrete situation)

The left and/or right arrow is/are illuminated. The analog display is deflecting.

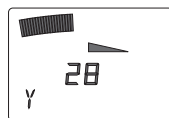

- Rotate the antenna A3-S so that the deflection of the digital display is as wide as possible. The arrows now show the direction of the line. It is, however, very likely that you are as yet not directly above the line.



- Watch the arrow indications. Move laterally in the direction of the displayed arrow (left arrow , move laterally to the left, right arrow , move laterally to the right).

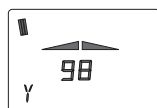

A double arrow will appear as soon as you are directly above the line. The analog display shows a minimum value while the digital display (field strength) shows a maximum value.

## Depth measurement



### Note:

The depth measuring provides very imprecise results in the Radio frequency range. For this reason, a different frequency range should be used for the measuring process if possible.

The value determined during depth measurement is the distance between the lower edge of the antenna A3-S and the centre of the line.

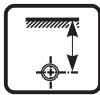

- Hold the antenna A3-S exactly above the line in an upright position. The lower edge of the antenna must touch the ground.
- Press the depth key.  
The depth of the line and the current strength in the conductor in mA appear in the display.
- Verify the value by conducting a second measuring process. In order to do so, lift the antenna A3-S as far as you can do so holding it comfortably (lower edge approx. 30cm above ground)
- Press depth key once again.  
The value now displayed must be higher than the value of the first measurement while such difference must represent the distance difference after the antenna was lifted.

**Measuring tolerance** for a single straight line:

Depth of the line [m]	Tolerance [m]
0	0,1
1	0,1
3	0,3

## 6.2 Brief instruction on water leak detection

### Preliminary location

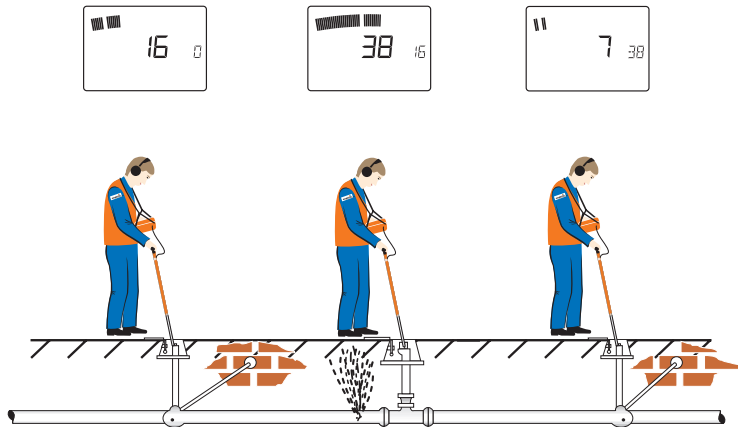

- Connect the headphones to the **AF 100**.
- Connect the test rod to the **AF 100**.
- Place test rod on the first measurement point.
- Activate the **AF 100** with the gauntlet key or the microphone key. A speaker symbol appears in the display during measurement. The analog display indicates the current measurement volume. The noise can be heard by the headphones. During this measurement the big digital display indicates the smallest value measured. During this measurement the small digital display indicates the smallest value of the precedent measurement. For the first measurement this value is 0. During this measurement the smallest measured value is shown in the analog display in reverse video.
- To deactivate the **AF 100** release the gauntlet key or press the microphone key again. If the **AF 100** is not deactivated when the gauntlet key is released, the function of the gauntlet key has been changed (see section 5.9). In this event press the gauntlet key again.
- Place the test rod on the next measurement point and proceed exactly as described above. The previously measured value now appears in the small digital display for the purposes of comparison.

## Pin pointing

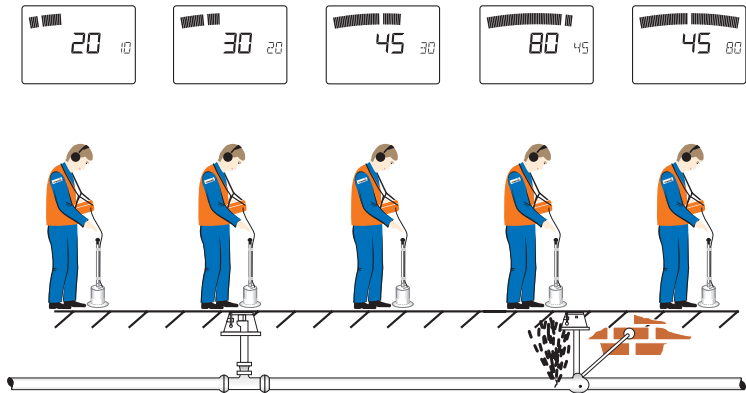

- Instead of a test rod connect a ground microphone to the **AF 100**.
- Place the microphone on the ground.
- Activate the **AF 100** with the gauntlet key or the microphone key. A speaker symbol appears in the display during measurement. The analog display indicates the current measurement volume. The current noise can be heard through the headphones. The digital display indicates the smallest value measured. The small digital display indicates the previously-measured value. For the first measurement this value is 0. The smallest measured value is shown in the analog display in reverse video.
- To deactivate the **AF 100** release the gauntlet key or press the microphone key again. If the **AF 100** is not deactivated when the gauntlet key is released, the function of the gauntlet key has been changed (see section 5.9). In this event press the gauntlet key again.
- Place the ground microphone on the next measurement point and proceed exactly as described above. The previously measured value now appears in the small digital display for the purposes of comparison.
- Use the ground microphone to check the area of the section where the leak is thought to be.



## 7 Malfunctions

Malfunctions of the device are indicated through an error message on the display.

An F and an error code will be displayed.

<b>Error code</b>	<b>Description</b>	<b>Error behaviour</b>	<b>Remedy</b>
<b>10</b>	EL, AF 100 not recognised	self-retaining	Switch device back on, SEWERIN service
<b>40</b>	Temperature at battery too high for charging (> 45°C)	self-retaining	Improve device surroundings, SEWERIN service
<b>41</b>	Temperature at battery too low for charging (< 0°C)	self-retaining	Improve device surroundings, SEWERIN service
<b>52</b>	Data flash error occurred	self-retaining	Switch device back on, SEWERIN service
<b>60</b>	Error in communication with A3/A3-S probe	Self-resetting	Switch device back on, SEWERIN service
<b>61</b>	Incorrect A3 probe adjustment parameters	self-retaining	Switch device back on, SEWERIN service
<b>64</b>	Incorrect A3 probe adjustment parameters	self-retaining	Switch device back on, SEWERIN service

---

<b>Error code</b>	<b>Description</b>	<b>Error behaviour</b>	<b>Remedy</b>
<b>100</b>	Error at probe	self-retaining	Switch device back on, manually select probe, SEWERIN service
<b>110</b>	Probe detected by device wrong	self-retaining	Switch device back on, manually select probe, SEWERIN service
<b>210</b>	Communication error with CODEC	Self-resetting	Switch device back on, SEWERIN service
<b>239</b>	DSP error in boot program	self-retaining	Switch device back on, SEWERIN service
<b>240</b>	DSP error when loading firmware	self-retaining	Switch device back on, SEWERIN service
<b>241</b>	Communication error with DSP	Self-resetting	Switch device back on, SEWERIN service

## 8 Specifications

<b>Fab-no.:</b>	
<b>EL</b>	035 11
<b>AF 100</b>	036 11
<b>Reception frequencies (EL und AF 100):</b>	A = 41666 Hz; B= 9950 Hz; C = 1100 Hz; 50/60 Hz; 100 Hz; Radio range 15 – 25 kHz
<b>Reception frequency:</b>	PIG (21,5 Hz)
<b>Transmission bandwidth (AF 100):</b>	1 – 10000 Hz
<b>Filter, adjustable:</b>	steps of 50, 500 and 1000 Hz
<b>Filter, minimum bandwidth:</b>	300 Hz
<b>Illuminated display:</b>	analog display and digital field-strength display depth display [m] Positional display (arrows)
<b>Power supply:</b>	<b>built-in rechargeable accumulator (NiMH)</b> integral automatic charging/buffer system Displayed battery status Operating time approx. 12 hours
<b>Type of protection in operation:</b>	IP65
<b>Weight:</b>	approx. 1,0 kg
<b>Approximate dimensions:</b>	(W × H × D): 12.5 × 18 × 6.5 cm
<b>Temperature range:</b>	operation -10 °C – +50 °C storage -25 °C – +70 °C

## 9 Accessories

### 9.1 Accessories for Pipeline location

#### **Antenna A3-S**

For the determination of position and depth

#### **Generator G1**

This high-powered transmitter (up to 50 W or 1 A) is designed for the location of water and gas pipes over large distances.

#### **Generator G2**

This low-powered transmitter (1 W or 100 mA) is designed for the location of well-insulated gas pipes and cables.

#### **Step voltage probe EL02**

For locating insulation and cable faults.

#### **AZ 5 cable clamps**

Used for both transmission and reception with pipes and cables up to 50 mm in diameter.

#### **Small search coil SK 3**

#### **Electro mains adapter ENA**

#### **Glass-fibre probe system**

For locating non-metallic lines.

### 9.2 Accessories for water leak detection

**Piezo-Testrod T-4, with screwed on tip.**

**Ground microphone BO-4**

With sound-proofed against extraneous noise, especially suitable for stabilised surfaces.

**Carrying rod H-4**

For ground microphones BO-4 and 3P-4

**Ground microphone 3P-4**

with tripod, for both stabilised and unstabilised surfaces, with screw-on 20-cm measuring spike.

**Test rod extension 60 cm**

needed for listening to valves in shafts

**Valve adapter**

**Gate valve adapter**

**Piezo-microphone EM30**

especially suitable for use in buildings.

### 9.3 General accessories

**Headphones stereo**

**Docking station HS**

**Case AF 100 resp. case EL**

Case with foam inlay, special transport protection, incorporated pockets for accessories, device may be charged inside the case.

**AC/DC adapter M4**

**Vehicle cable M4**

**Carrying system Triangel**

adjustable upholstered back belt

**Carrying system Cross Belt**

Carrying system „Cross Belt“, 2 adjustable straps with diagonal attachment points. The straps cross over at the back for extra comfort.

## 10 Annexe

### 10.1 EU declaration of conformity

Hermann Sewerin GmbH hereby declares that the **AQUAPHON AF 100/FERROPHON EL** fulfils the requirements of the following guideline:

- 2014/30/EU

The complete declaration of conformity can be found online.

## 10.2 Hints on Disposal

The disposal of instruments and accessories is governed by the European Waste Catalogue (EWC).

Type of Waste	Corresponding EWC Code
Instrument	16 02 13
Battery, accu	16 06 05

### Old Instruments

Old instruments can be returned to Hermann Sewerin GmbH. We will arrange the qualified disposal free of charge through certified specialists.

## 10.3 Record of changes

### Version 4.2

#### Water leak detection

- **Display:** set to sensitivity ranges 1–10, 1–100, 1–1000, switch via magnifying-glass key
- **Factory settings:** sound protection functions only active at middle threshold. This threshold is active after renewed power-up.
- **Band filter acc. to micro type** (manually adjustable to 9,950 Hz):

BO-4:	50–1500 Hz
T-4:	50–3000 Hz
EM30, M01:	50–9950 Hz
- **Pre-amplification** matched to micro-types

### Version 5.0

#### Water leak detection

- Radio microphones usable

#### Pipeline location

- Receive range 50 Hz extended to 50–60 Hz
- Receive range 16 2/3 Hz removed
- Receive range PIG (21,5 Hz) inserted for pig location with FS20.
- Direct hearing of frequencies 50–60 Hz and 100 Hz possible. (Special variation)

#### General

- If the accu-voltage is lower than the accu-nominal voltage, the device is being recharged.
- The version number of the software is displayed on switch-on.

### Version 5.2

#### Water leak detection

- Marker for system Combiphon (max level is stored)

#### Pipeline location

- Loudspeaker with impulse signals for better audibility

#### General

- Version with battery power possible



## **Version 6.0**

### **Pipeline location**

- Antenna A3-S replaces antenna A-3  
(Antenna A3 can be used, its functionality is, however, limited.  
Refer to the A3 operating instructions)!
- Antenna A3-S does not require the maximum difference method  
which is why this method was removed.

## **Version 7.0**

### **General**

- Use of new hardware resulting in a weight reduction from 1.4  
to 1.0 kg.
- In this version, the programme is stored in a flash memory and  
no longer in a EPROM.
- Quick charging due to NiMH batteries.

### **Water leak detection**

- The lowest level of the band-pass filter is set from 50 Hz to  
1 Hz. This allows for hearing even lower frequencies.

### **Pipeline location**

- The analog display (and thus the headphones output) is calcu-  
lated differently: outliers, which used to be present at the side  
of lines, have been reduced and/or removed.
- Direct hearing of 50 and 100 Hz is no longer an optional feature  
but now standard.
- Selection option for special frequencies through the ABC key

## **Version 8.0**

### **Pipeline location**

- Revision of the function magnifying-glass key. Manual modula-  
tion of the displays.
- If headphones are used, a change will no longer be indicated  
by change of intensity – but by a change of pitch instead.

---

## 11 Index

### A

ABC key 16  
Accessories 1, 5, 75, 76  
Accuracy 41  
Active location 2, 5, 16  
Analog display 13, 30  
Antenna A3-S 23, 25

### B

Basic amplification 51, 55, 66  
Battery status 14  
Battery symbol 50  
Battery warning 15  
Brief instruction 68, 70

### C

Cable clamp 24, 45  
Cable faults 43, 44  
Carrying rod H-4 56  
Charging 9  
Charging equipment 9  
Charging status 7, 14  
Comment line 51, 59, 65, 66  
Core breaks 44  
Current strength 2, 19, 32, 33, 43, 45, 69  
Cursor keys 8, 19, 40, 54

### D

Depth determination 23, 28, 40, 48  
Depth key 8, 19, 32, 40  
Depth measurement 32, 69  
Digital display 14, 29, 31, 49, 60, 61, 68  
Direct acoustic output 18  
Display contrast 9  
Display function 35  
Displays 13

### E

Earth fault 43  
ELWset 65

### F

Factory settings 67  
Field distortions 42  
Following a line 31  
Frequency 16  
Frequency display 14  
Frequency range 16, 32, 53, 54, 69  
Frequency selection 16  
FS20 46

### G

Gauntlet key 52, 60, 63, 64, 66  
Generator 5, 16, 24, 28, 30, 36, 43, 44, 75  
Glass-fibre probe system 28, 34  
Ground microphone 3P-4 56, 76  
Ground microphone BO-4 56, 76, 79

### H

H-4 56, 76  
Headphones 12, 41, 50, 54, 59, 66  
Hz key 52, 53, 54

### I

Insulation fault 33, 75  
Interference 4, 72

### K

Key functions 16, 51

### L

Light key 9, 27, 36, 54  
Locating lines 28, 68

### M

Magnifying-glass key 8, 19, 20, 22, 36, 51, 55, 66, 79  
Manual probe selection 8  
MAX 49, 52  
Maximum-method 13, 21, 26  
Measurement inaccuracies 41  
Microphone key 8, 51  
Minimum-method 13, 26, 31, 35, 68  
Mini pig transmitter 28, 34, 36, 38, 40

### O

On/off key 55, 58, 65  
Optimising 41  
OVERFLOW 21  
Overview pipeline location 27

### P

Passive location 2, 4, 16  
Pearson method 2  
PIG 14, 16, 17  
Pin pointing 63  
Pipeline location 2, 4, 6, 12, 13, 14, 16,  
27, 29, 35, 41, 68  
Positional display 13, 35, 36  
Preliminary location 59  
Probe overview 23, 56  
Probe selection 8

### R

Radio 4, 14, 16  
Radio microphones 79  
Reception frequencies 16, 17, 74  
Reset 67

### S

Search coil FS3 A 24, 47, 48  
Search coil FS20 23, 46  
Search coil SK3 23, 46  
Self-discharge 11  
Setup 65, 66  
Short circuit 43, 44  
Software version 7, 25  
Speaker symbol 15, 18, 50, 60  
Stabilised surfaces 56  
Step-voltage probe EL02 24, 75  
Switch off 8, 16, 58  
Switch on 7, 16, 58  
Switch on/off 7

### T

Test rod T-4 57  
Tips 41, 42, 44  
Transmission bandwidth 74

### U

Unstabilised surfaces 56

### V

Volume 13, 19, 54, 60  
Volume display 50

### W

Water leak detection 2, 5, 6, 12, 49

**Hermann Sewerin GmbH**  
Robert-Bosch-Straße 3 · 33334 Gütersloh · Germany  
Telefon +49 5241 934-0 · Telefax +49 5241 934-444  
[www.sewerin.com](http://www.sewerin.com) · [info@sewerin.com](mailto:info@sewerin.com)