

Operating instruction

SeFlow 400

UMSeFlow_400V2-2EN



SEWERIN France
17 rue Ampère
67720 HOERDT
Frankreich

Tél. : +33 (03) 88 68 15 15
Fax : +33 (03) 88 68 11 77
E-mail : sewerin@sewerin.com
www.sewerin.com

Operating instruction for
SeFlow 400
UMSeFlow_400V2-2EN, 2022-03-01
Article number: 25383
Copyright (©) SEWERIN France 2022
Subject to change without prior notice.

Table of contents

1	Introduction	7
2	Safety instructions	9
2.1	General safety instructions	9
2.2	Intended use	9
2.3	Not intended use	10
2.4	Safety instructions for the user	10
2.5	Safety instructions for the operator	10
2.6	Safety instructions for electrical work	11
2.7	Safety instructions for transport	12
2.8	Recommended procedure in hazardous situations	12
3	General principles	13
3.1	Measurement principle	13
3.2	Measurement arrangements	18
3.3	Acoustic penetration	21
3.4	Undisturbed flow profile	23
4	Product description	25
4.1	Measuring system	25
4.2	Handling concept	25
4.3	Navigation	27
4.4	Keyboard	28
5	Transport and storage	30
5.1	Transport	30
5.2	Storage	30
6	Installation	31
6.1	Transmitter	31
6.2	Transducers	32
7	Connection	39
7.1	Transducers	39
7.2	Power supply	40
7.3	Outputs	42
7.4	Connection of the RS232 service interface	44

8	Start-up	45
8.1	Start-up settings	45
8.2	Switching on/off	46
8.3	Program branches	46
8.4	HotCodes	47
8.5	Language	48
8.6	Initialization	48
8.7	Time and date	49
8.8	Instrument information	50
9	Measurement	51
9.1	Parameter input	51
9.2	Measurement settings	56
9.3	Start of the measurement	67
9.4	Display of measured values	71
9.5	Execution of special functions	75
9.6	Determination of the flow direction	75
9.7	Stop of the measurement	75
10	Troubleshooting	76
10.1	Problems with the measurement	77
10.2	Measuring point selection	78
10.3	Maximum acoustic contact	78
10.4	Application-specific problems	78
10.5	Significant deviations of the measured values	79
10.6	Problems with the totalizers	80
11	Maintenance and cleaning	81
11.1	Maintenance	81
11.2	Cleaning	81
12	Dismounting and disposal	82
12.1	Dismounting	82
12.2	Disposal	82
13	Outputs	83
13.1	Installation of a binary output	83
13.2	Activation of a binary output as pulse output	85

14	Data logger	87
14.1	Activation/Deactivation of the data logger	87
14.2	Setting the storage rate	87
14.3	Configuration of the data logger	88
14.4	Measurement with activated data logger	91
14.5	Deletion of measured values	91
14.6	Information relating the data logger	92
15	Data transmission	93
15.1	FluxDiagReader/FluxDiag	93
15.2	Terminal program	93
15.3	Transmission parameters	95
15.4	Data format	96
15.5	Data structure	96
16	Advanced functions	99
16.1	Low-power mode	99
16.2	Night-flow mode	101
16.3	Totalizers	104
16.4	NoiseTrek parallel beam mode (optional)	106
16.5	Upper limit of the flow velocity	107
16.6	Cut-off flow	108
16.7	Profile correction	109
16.8	Uncorrected flow velocity	110
16.9	Diagnosis with the help of the snap function	111
16.10	Activation of a binary output as alarm output	112
16.11	Behavior of the alarm outputs	116

17	SuperUser mode	120
17.1	Activation/deactivation	120
17.2	Defining flow parameters	121
17.3	Setting of the measuring time in the low-power mode	124
17.4	Setting of measuring cycles in the night-flow mode	124
17.5	Limit of the signal amplification	125
17.6	Upper limit of the sound speed	126
17.7	Detection of long measurement failures	128
17.8	Number of decimal places of the totalizers	128
17.9	Manual reset of the totalizers	129
17.10	Display of the totalizer sum	130
17.11	Display of the last valid measured value	130
17.12	Displays during the measurement	131
18	Settings	132
18.1	Dialogs and menus	132
18.2	Measurement settings	135
18.3	Contrast settings	138
18.4	Program code	138

Annex

A	Menu structure	141
B	Units of measurement	149
C	Reference	153

1 Introduction

This operating instruction has been written for users operating the ultrasonic flowmeter SeFlow. It contains important information about the measuring equipment, how to handle it correctly, and how to avoid damages. Read the safety instructions carefully. Make sure you have read and understood this operating instruction before using the measuring equipment.

Any work on the measuring equipment has to be carried out by authorized and qualified personnel in order to detect and avoid possible risks and dangers.

Presentation of warnings

This operating instruction contains warnings marked as follows:

Danger!



Type and source of danger

danger with high level of risk, which if not avoided, can lead to death or serious injuries

→ measures of prevention

Warning!



Type and source of danger

danger with medium level of risk, which if not avoided, can lead to death or serious injuries

→ measures of prevention

Caution!



Type and source of danger

danger with low level of risk, which if not avoided, can lead to minor or moderate injuries

→ measures of prevention

Important!

This text contains important information which should be observed to avoid material damage.

Notice!

This text contains important information about the handling of the measuring equipment.

Storage of the operational manual

The operating instruction must permanently be available at the place where the measuring equipment is used. It must always be available to the user.

User comments

All reasonable effort has been made to ensure the correctness of the content of this operating instruction. If you however find some erroneous information or miss information, please inform us.

We will be grateful for any suggestions and comments regarding the concept and your experience working with the measuring equipment. If you have any suggestions about improving the documentation and particularly this operating instruction, please let us know so that we can consider your comments for future reprints.

Copyright

The contents of this operating instruction are subject to changes without prior notice. All rights reserved. No part of this operating instruction may be reproduced in any form without SEWERIN's written permission.

2 Safety instructions

2.1 General safety instructions

Prior to any work, read the operating instruction carefully and in full.

Failure to comply with the instructions, in particular with the safety instructions, poses a risk to health and can lead to material damages. For further information, contact SEWERIN.

During installation and operation of the measuring equipment, observe the ambient and installation conditions specified in the documentation.

The measuring equipment has to be checked for proper condition and operational safety before each use. If troubles or damages have occurred during installation or operation of the measuring equipment, please inform SEWERIN.

It is not allowed to make unauthorized modifications or alterations to the measuring equipment.

The personnel has to be suitably trained and experienced for the work.

2.2 Intended use

The measuring equipment is intended for the measurement of fluid properties in closed pipes. By means of connected transducers, the transit times of the ultrasonic signals in the fluid and the pipe are measured and evaluated.

The transmitter uses these values to calculate the sought quantities, e.g., volumetric flow rate, mass flow rate, heat quantity, density and concentration. Through comparison with the values stored in the transmitter further physical quantities can be determined. The physical quantities are provided via configurable outputs and the display.

- All instructions of this operating instruction have to be observed to ensure intended use.
- Any use beyond or other than the intended use is not covered by warranty and can present a danger. Any damage arising from not intended use shall be solely the liability of the operator or user.
- The measurement is carried out without direct contact to the fluid in the pipe. The flow profile is not influenced.
- The transducers are fixed to the pipe using the supplied transducer mounting fixture.
- Observe the operating conditions, e.g., environment, voltage ranges. For the technical data of the transmitter, transducers and accessories, see technical specification.

2.3 Not intended use

Not intended use in terms of a misuse means:

- any work on the measuring equipment without observing all instructions in this operating instruction
- use of transmitter, transducer and accessories combinations not intended by SEWERIN
- installation of the transmitter, transducers and accessories in explosive atmospheres they are not approved for
- any work on the measuring equipment (e.g., installation, dismantling, connection, start-up, operation, service and maintenance) carried out by unauthorized and untrained personnel
- storage, installation and operation of the measuring equipment outside the specified ambient conditions, see technical specification

2.4 Safety instructions for the user

Any work on the transmitter has to be carried out by authorized and qualified personnel. Observe the safety instructions in the operating instruction. For the technical data of the transmitter, transducers and accessories, see technical specification.

- Observe the safety and accident prevention regulations applicable on the site of operation.
- Only use the supplied mounting fixtures and transducers as well as the intended accessories.
- Always wear the required personal protective equipment.

2.5 Safety instructions for the operator

- The operator shall qualify the personnel to perform their assigned tasks. The operator shall provide the required personal protective equipment and oblige the personnel to wear it. It is recommended to risk assess the workplace.
- Besides the safety instructions in this operating instruction, the health, safety and environment regulations applicable for the range of application of the transmitter, transducers and accessories have to be observed.
- With the exceptions stated in chapter 11, the measuring equipment is maintenance-free. Any components and spare parts may only be replaced by SEWERIN. The operator shall carry out periodic checks for changes or damages that can present a danger. For further information, contact SEWERIN.
- Observe the specifications for the installation and connection of the transmitter, transducers and accessories, see chapter 6 and 7.

2.6 Safety instructions for electrical work

- Electrical work may only be carried out if there is enough space.
- The degree of protection of the transmitter is only ensured if the cables are firmly connected to the transmitter and all unused connections are covered.
- The condition and tight fit of the electrical connections have to be checked at regular intervals.
- The power supply unit for charging the battery may only be connected to networks up to overvoltage category II. Use only the supplied power supply unit. For the power supply via power cable and power adapter, observe the safety instructions in chapter 7, section 7.2.
- The transmitter and the power supply unit must not be disassembled, see Fig. 2.1. The transmitter does not contain any components to be maintained by the user. For repair and service work, please contact SEWERIN.
- Observe the safety and accident prevention regulations for electrical systems and equipment.

Fig. 2.1: Transmitter

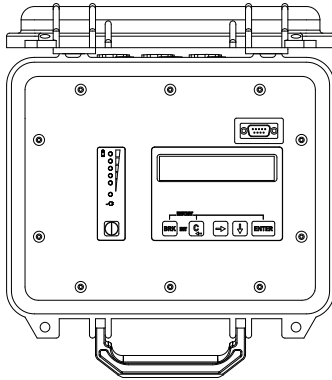

2.7 Safety instructions for transport

- If you detect a transport damage when unpacking the delivery, please contact the supplier or SEWERIN immediately.
- The transmitter is a sensitive electronic measuring instrument. Avoid shocks or impacts.
- Handle the transducer cable with care. Avoid excessive bending or buckling. Observe the ambient conditions.
- Select a solid surface to put the transmitter, transducers and accessories on.
- The transmitter, transducers and accessories have to be properly packed for transport:
 - Use, if possible, the original packaging by SEWERIN or an equivalent cardboard box.
 - Position the transmitter, transducers and accessories in the middle of the cardboard box.
 - Fill any voids with appropriate packaging material (e.g., paper, foam, bubble wrap).
 - Protect the cardboard box against humidity.

2.8 Recommended procedure in hazardous situations

Fire fighting measures

- If possible, disconnect the transmitter from the power supply.
- Prior to extinguishing, protect any electrical parts that are not affected by the fire (e.g., using a cover).
- Select a suitable extinguishing agent. Avoid, if possible, conductive extinguishing agents.
- Observe the applicable minimum distances. The minimum distances differ depending on the used extinguishing agent.

3 General principles

In the ultrasonic flow measurement, the flow velocity of the fluid in a pipe is determined. Further physical quantities are derived from the flow velocity and from additional physical quantities, if necessary.

3.1 Measurement principle

The flow velocity of the fluid is measured using the transit time difference correlation principle.

3.1.1 Terms

Flow profile

Distribution of flow velocities over the cross-sectional pipe area. For an optimal measurement, the flow profile has to be fully developed and axisymmetrical. The shape of the flow profile depends on whether the flow is laminar or turbulent and is influenced by the conditions at the inlet of the measuring point.

Reynolds number Re

Coefficient describing the turbulence behavior of a fluid in the pipe. The Reynolds number Re is calculated from the flow velocity, the kinematic viscosity of the fluid and the inner pipe diameter.

If the Reynolds number exceeds a critical value (usually approx. 2300, if the fluid flows in a pipe), a transition from a laminar flow to a turbulent flow takes place.

Laminar flow

A flow without any turbulence. There is no mixing between the parallel flowing layers of the fluid.

Turbulent flow

A flow with turbulences (swirling of the fluid). In technical applications, the flow in the pipe is mostly turbulent.

Transition range

The flow is partly laminar and partly turbulent.

Sound speed c

Speed of the propagating sound. The sound speed depends on the mechanical properties of the fluid or the pipe material. In pipe materials and other solid materials, a distinction is made between the longitudinal and transversal sound speed. For the sound speed of some fluids and materials, see annex C.

Flow velocity v

Average value of all flow velocities of the fluid over the cross-sectional pipe area.

Acoustic calibration factor k_a

$$k_a = \frac{c_\alpha}{\sin \alpha}$$

The acoustic calibration factor k_a is a transducer parameter which results from the sound speed c within the transducer and the angle of incidence. According to Snell's law of refraction, the angle of propagation in the adjoining fluid or pipe material is:

$$k_a = \frac{c_\alpha}{\sin \alpha} = \frac{c_\beta}{\sin \beta} = \frac{c_\gamma}{\sin \gamma}$$

Fluid mechanics correction factor k_{Re}

With the fluid mechanics calibration factor k_{Re} , the measured value of the flow velocity in the area of the sound beam is converted into the value of the flow velocity across the whole cross-sectional pipe area. In case of a fully developed flow profile, the fluid mechanics calibration factor only depends on the Reynolds number and the roughness of the inner pipe wall. The fluid mechanics calibration factor is recalculated by the transmitter for each new measurement.

Volumetric flow rate \dot{V}

$$\dot{V} = v \cdot A$$

The volume of the fluid that passes through the pipe per unit time. The volumetric flow rate is calculated from the product of the flow velocity v and the cross-sectional pipe area A .

Mass flow rate \dot{m}

$$\dot{m} = \dot{V} \cdot \rho$$

The mass of the fluid that passes through the pipe per unit time. The mass flow rate is calculated from the product of the volumetric flow rate \dot{V} and the density ρ .

3.1.2 Measurement of the flow velocity in the TransitTime mode

The signals are emitted and received by 2 transducers alternatively in and against the flow direction. If the fluid is flowing, the signals propagating in the fluid are displaced with the flow.

Caused by this displacement, the sound path of the signal in flow direction is reduced and the signal against the flow direction is increased, see Fig. 3.1 and Fig. 3.2.

This causes a change in the transit times. The transit time of the signal in flow direction is shorter than the transit time against the flow direction. The transit time difference is proportional to the average flow velocity.

The average flow velocity of the fluid is calculated as follows:

$$v = k_{Re} \cdot k_a \cdot \frac{\Delta t}{2 \cdot t_\gamma}$$

where

- v – average flow velocity of the fluid
- k_{Re} – fluid mechanics calibration factor
- k_a – acoustic calibration factor
- Δt – transit time difference
- t_γ – transit time in the fluid

Fig. 3.1: Sound path of the signal in the flow direction

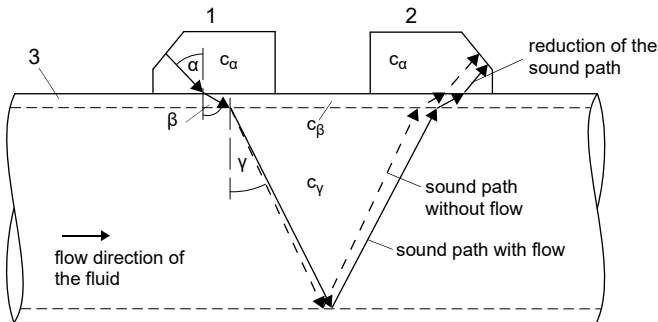

- c – sound speed
- 1 – transducer (emitter)
- 2 – transducer (receiver)
- 3 – pipe wall

Fig. 3.2: Sound path of the signal against the flow direction

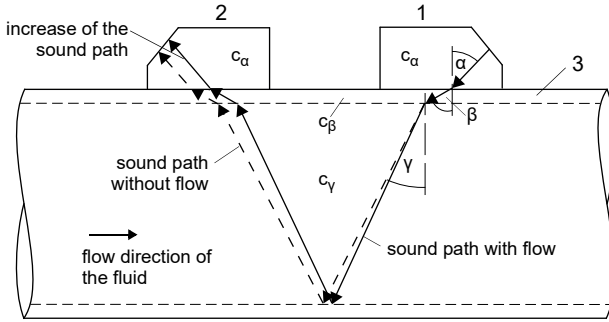

- c – sound speed
- 1 – transducer (emitter)
- 2 – transducer (receiver)
- 3 – pipe wall

Fig. 3.3: Transit time difference Δt

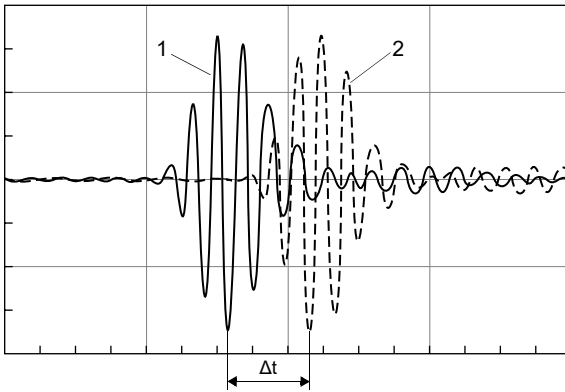

- 1 – signal in the flow direction
- 2 – signal against the flow direction

3.1.3 Measurement of the flow velocity in the NoiseTrek parallel beam mode (optional)

Pipes with a small pipe diameter or fluids which strongly attenuate the ultrasonic signal can cause a reduction of the transit time in the fluid with the result that the signal quality is no longer sufficient. In this case the NoiseTrek parallel beam mode has to be used.

The NoiseTrek parallel beam mode uses the presence of gas bubbles and/or solid particles in the fluid.

Ultrasonic signals are sent into the fluid at short intervals, reflected by the gas bubbles and/or the solids particles and again received. This leads to a better signal quality. The transducers are mounted in parallel on the pipe at a small distance, see Fig. 3.4.

A measurement in TransitTime mode is not possible when working with this measurement arrangement.

Fig. 3.4: Measurement arrangement in the NoiseTrek parallel beam mode

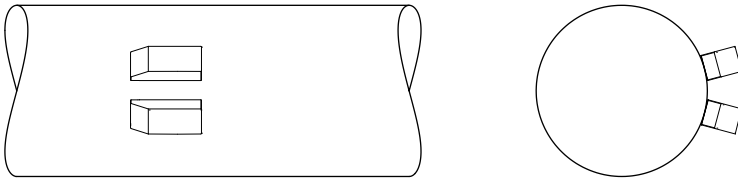

The transit time difference Δt of 2 consecutive ultrasonic signals is determined. It behaves proportionately to the distance the gas bubble/solid particle is covering between 2 consecutive pulses and thus, to the average flow velocity of the fluid, see Fig. 3.5.

Fig. 3.5: Measurement of the flow velocity in the NoiseTrek parallel beam mode

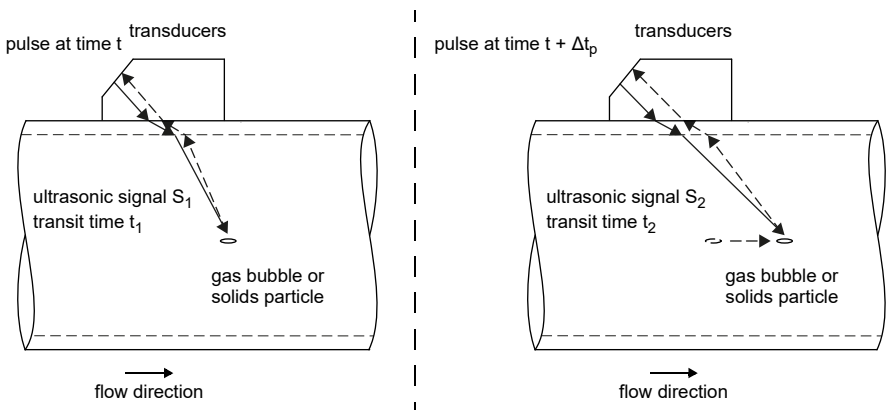

The average flow velocity of the fluid is calculated as follows:

$$v = k_{Re} \cdot k_a \cdot \frac{\Delta t}{2 \cdot \Delta t_p}$$

where

v – average flow velocity of the fluid

k_{Re} – fluid mechanics calibration factor

k_a – acoustic calibration factor

Δt_p – time difference between 2 consecutive pulses

Δt – transit time difference of ultrasonic signals S_1 and S_2 ($\Delta t = t_2 - t_1$)

3.2 Measurement arrangements

3.2.1 Terms

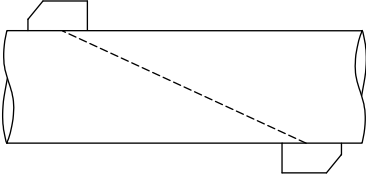
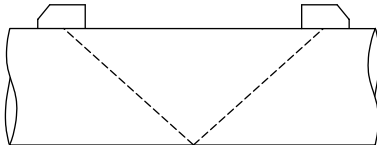
Diagonal arrangement	Reflection arrangement
The transducers are mounted on opposite sides of the pipe.	The transducers are mounted on the same side of the pipe.
	

Sound path

The distance covered by the ultrasonic signal after crossing the pipe once. The number of the sound paths is:

- odd if the measurement is carried out in diagonal arrangement
- even if the measurement is carried out in reflection arrangement

Beam

The path covered by the ultrasonic signal between the transducers, i.e., the transducer emitting the ultrasonic signal and the transducer receiving it. One beam consists of 1 or several sound paths.

Fig. 3.6: Diagonal arrangement with 1 beam and 3 sound paths

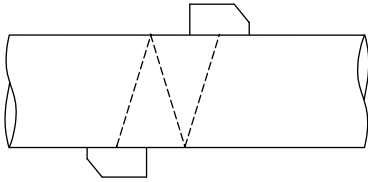
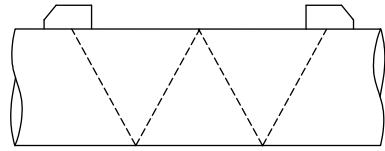
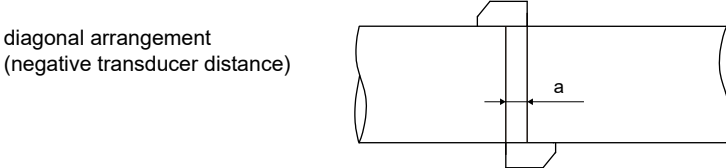
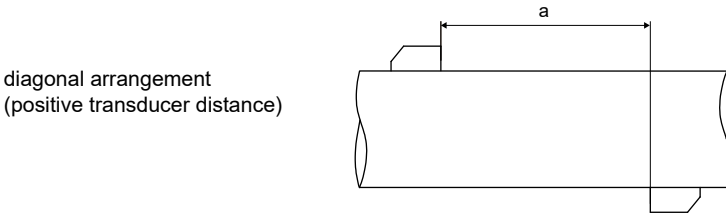
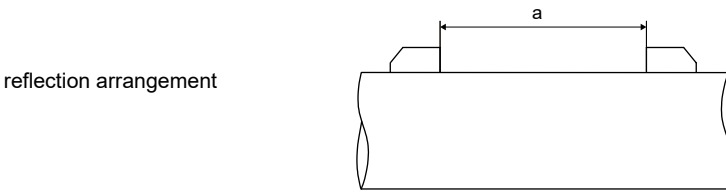

Fig. 3.7: Reflection arrangement with 1 beam and 4 sound paths



Transducer distance

The transducer distance is measured between the inner edges of the transducers.



a – transducer distance

Sound beam plane

plane, containing sound paths or beams

Fig. 3.8: 2 sound paths in 1 plane

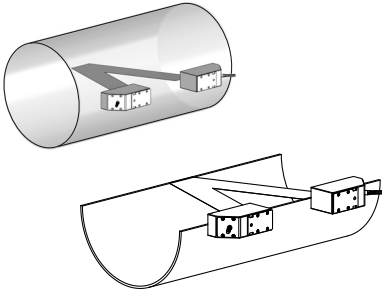

3.2.2 Examples

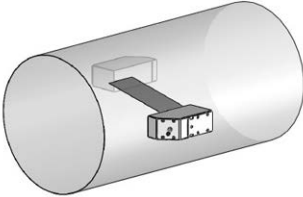
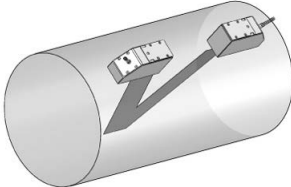
Diagonal arrangement with 1 beam	Reflection arrangement with 1 beam
<p>1 transducer pair 1 sound path</p> 	<p>1 transducer pair 2 sound paths</p> 

3.3 Acoustic penetration

The pipe has to be acoustically penetrable at the measuring point. The acoustic penetration is given when pipe and fluid do not attenuate the sound signal so strongly that it is completely absorbed before reaching the second transducer.

The attenuation caused by the pipe and the fluid depends on:

- kinematic viscosity of the fluid
- proportion of gas bubbles and solids in the fluid
- deposits on the inner pipe wall
- pipe material

The following requirements have to be met at the measuring point:

- the pipe is always completely filled
- no solid deposits in the pipe
- no bubble formation in the pipe

Notice!

Even bubble-free fluids can form gas bubbles when the fluid expands, e.g., before pumps and after great cross-section extensions.

Observe the following notes on the selection of the measuring point:

Horizontal pipe

Select a measuring point where the transducers can be mounted laterally on the pipe, allowing the sound waves to propagate horizontally in the pipe. Thus, solids on the bottom of the pipe or gas bubbles in the pipe's upper part are prevented from influencing the propagation of the signal, see Fig. 3.9 and Fig. 3.10.

Fig. 3.9: Recommended transducer mounting position

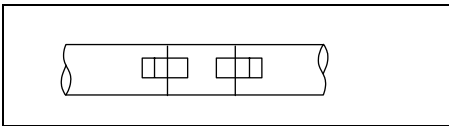
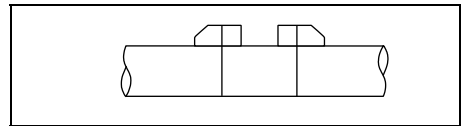

Fig. 3.10: Disadvantageous transducer mounting position



Vertical pipe

Select the measuring point at a pipe location where the fluid flows upward. The pipe has to be completely filled, see Fig. 3.11 and Fig. 3.12.

Fig. 3.11: Recommended transducer mounting position

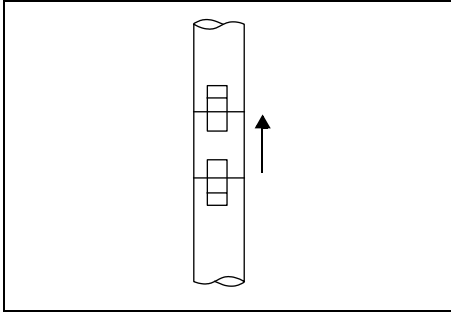
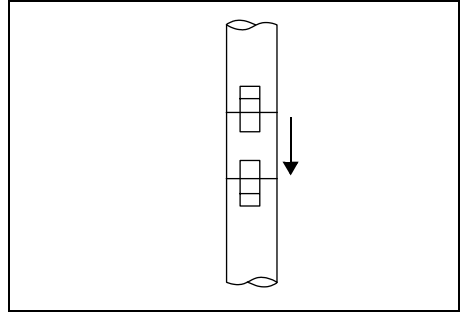

Fig. 3.12: Disadvantageous transducer mounting position



Free inlet or outlet pipe section

Select the measuring point at a pipe section where the pipe cannot run empty, see Fig. 3.13 and Fig. 3.14.

Fig. 3.13: Recommended transducer mounting position

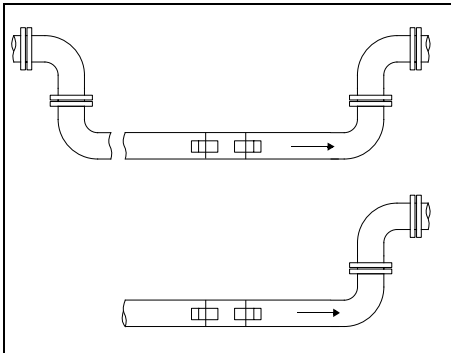
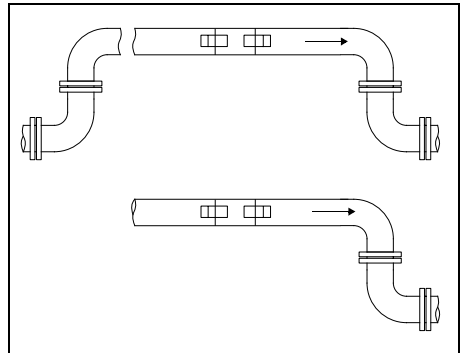

Fig. 3.14: Disadvantageous transducer mounting position



3.4 Undisturbed flow profile

Some flow elements (e.g., elbows, valves, pumps, reducers) distort the flow profile in their vicinity. The axisymmetrical flow profile in the pipe needed for correct measurement is no longer given. A careful selection of the measuring point helps to reduce the impact of disturbance sources.

It is most important that the measuring point is chosen at a sufficient distance from any disturbances. Only then it can be assumed that the flow profile in the pipe is fully developed. However, measuring results can be obtained even if the recommended distance to disturbances cannot be met for practical reasons (no ideal inflow, see section 16.7).

The recommended straight inlet and outlet pipe lengths for different types of flow disturbance sources are shown in the examples in Tab. 3.1.

Tab. 3.1: Recommended distance from disturbance sources
 D – nominal pipe diameter at the measuring point
 l – recommended distance between disturbance source and transducer position

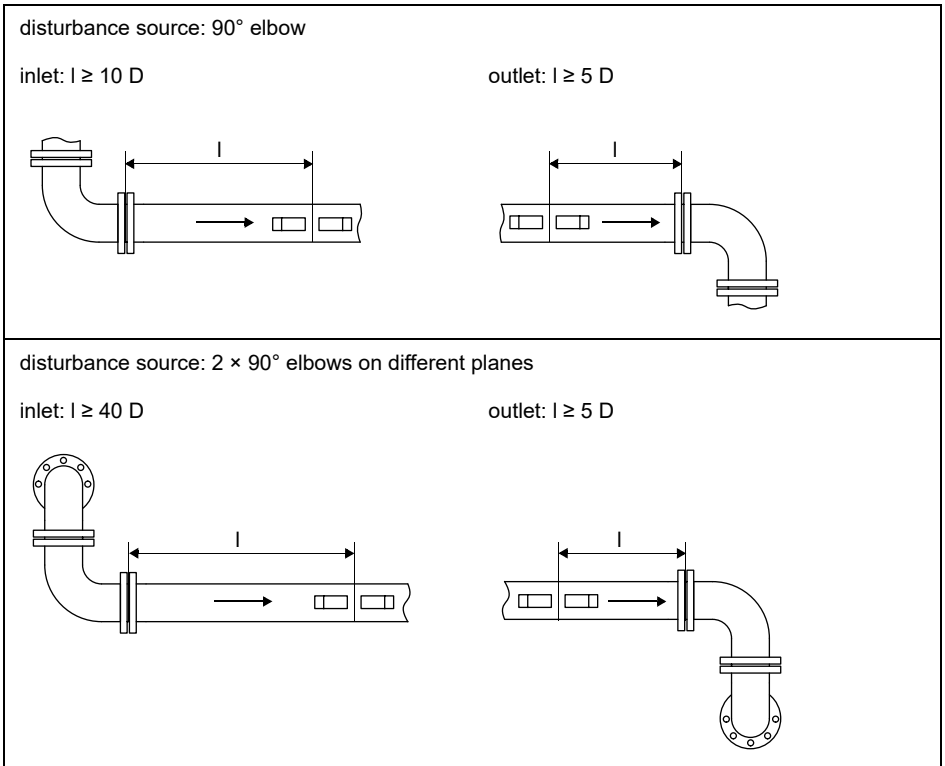

Tab. 3.1: Recommended distance from disturbance sources

D – nominal pipe diameter at the measuring point

l – recommended distance between disturbance source and transducer position

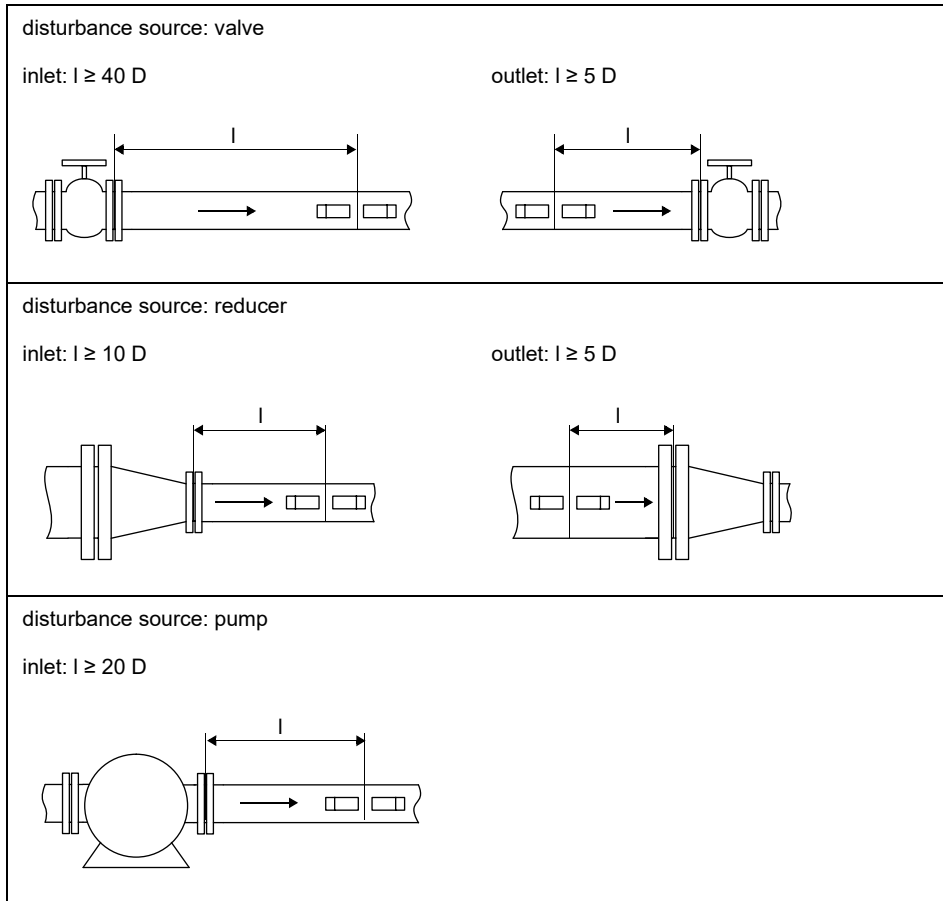

4 Product description

4.1 Measuring system

The measurement system consists of a transmitter, the ultrasonic transducers and the pipe on which the measurement is carried out, see Fig. 4.1.

Fig. 4.1: Example for a measurement arrangement

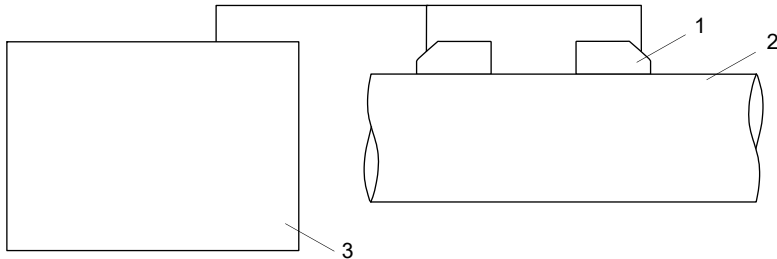

- 1 – transducer
- 2 – pipe
- 3 – transmitter

The ultrasonic transducers are mounted on the pipe. They send and receive ultrasonic signals through the fluid.

The transmitter controls the measuring cycle, eliminates noise signals and analyzes useful signals. The measured values can be displayed, used for calculations and transmitted by the transmitter.

4.2 Handling concept

The transmitter is operated via the keyboard. The keyboard can be accessed by opening the cover.

The selected program branch is displayed in angle brackets and capital letters, see Fig. 4.2. The complete name of the selected program branch is displayed in the lower line.

Select a program branch with key and . Press ENTER.

- par (Parameter)
- mea (Measuring)
- opt (Output Options)
- sf (Special Funct.)

Fig. 4.2: Command panel of the transmitter

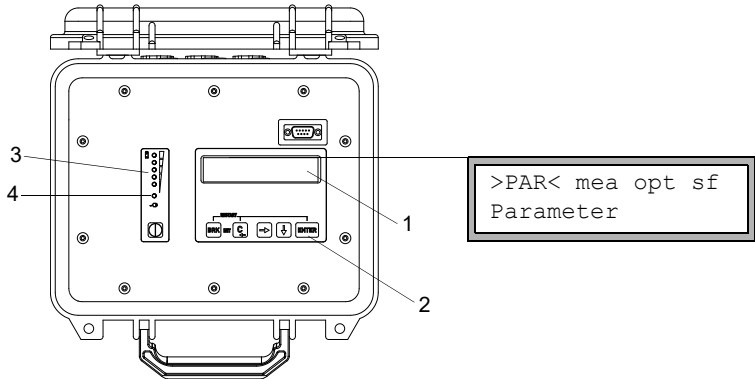

- 1 – display
- 2 – keyboard
- 3 – status indicator "charge state"
- 4 – status indicator "power supply"

For a description of the individual program branches, see Tab. 4.1.

Tab. 4.1: Description of the program branches



program branch	description
Parameter	Before starting a measurement, the transducer, pipe and fluid parameters have to be entered in the program branch <code>Parameter</code> .
Measuring	After the input of the transducer distance, the measurement is started in the program branch <code>Measuring</code> .
Output Options	Channel-related settings such as determination of the physical quantity, unit of measurement and parameters for the transmission of measured values are set in the program branch <code>Output Options</code> .
Special Funct.	Includes global settings which are not directly related to the measurement.

4.3 Navigation

4.3.1 Scroll lists



If a vertical arrow ↑ is displayed, the menu item contains a scroll list. The current list item is displayed in the lower line.

```
Special Funct. ↑
SYSTEM settings
```

- Press key  and  to scroll and select a list item in the lower line.
- Press ENTER.



Some menu items contain a horizontal scroll list in the lower line. The selected list item is displayed in angle brackets and capital letters.

```
Lining
no          YES
```

- Press key  and  to scroll and select a list item in the lower line.
- Press ENTER.

Some menu items contain a horizontal scroll list in the upper line. The selected list item is displayed in angle brackets and capital letters. The current value of the list item is displayed in the lower line.

```
R1=FUNC< typ mode
Function    MAX
```

- Press key  to scroll and select a list item in the upper line.
- Press key  to scroll and select a value for the selected list item in the lower line.
- Press ENTER.

4.3.2 Input fields

```
OUTER DIAMETER
100.0      mm
```

- Enter the value with keys  and , see Tab. 4.6.
- Press ENTER.

4.3.3 Status indications

The status indicators only light if the transmitter is switched on and the display light is activated.



Tab. 4.2: Status indicator "power supply"

LED flashes green	transmitter is connected to the power supply; battery is charging
LED lights green	transmitter is connected to the power supply, battery is charged
LED flashes red	battery almost empty
LED shortly flashes red every 5 s	transmitter in low-power or night-flow mode

Tab. 4.3: Status indicator "charge state" (red LEDs)

LEDs light	number of LED lights displays the charge state of the battery (not in low-power and in night-flow mode)
------------	---



4.4 Keyboard

The keyboard has 6 keys: I/O, ENTER, BRK, C,  and .



Tab. 4.4: General functions

I/O	switching the transmitter on/off switching the display light on/off switching off the transmitter by pressing key I/O for 3 seconds
ENTER	confirmation of selection or input
BRK + C	INIT: When switching on the transmitter press these 2 keys simultaneously to execute the initialization, see section 8.6.
BRK + C + ENTER	Reset: press these 3 keys simultaneously to correct a malfunction. The reset has the same effect as a restart of the transmitter. Stored data are not affected.
BRK	interruption of the measurement and selection of the main menu Be careful not to stop a current measurement by inadvertently pressing key BRK.



Tab. 4.5: Navigation

	scroll to the right or up through a scroll list
	scroll to the left or down through a scroll list

Tab. 4.6: Input of numbers

	move the cursor to the right
	scroll through the numbers above the cursor
C	<p>move the cursor to the left</p> <p>If the cursor is on the left margin:</p> <ul style="list-style-type: none"> • an already edited value will be reset to the value which was stored previously • an unedited value will be deleted <p>If the entered value is not valid, an error message will be displayed. Press ENTER and enter a correct value.</p>

Tab. 4.7: Input of text

	move the cursor to the right
	scroll through the characters above the cursor
C	reset all characters to the last stored entry

5 Transport and storage

Caution!



When packaging, the transmitter can fall down.

There is a danger of crushing body parts or damaging the measuring equipment.

→ Secure the transmitter against falling during packaging. Wear the required personal protective equipment. Observe the applicable rules.

Caution!



When lifting, the center of gravity of the transmitter can be displaced within the cardboard box. The transmitter can fall down.

There is a danger of crushing body parts or damaging the measuring equipment.

→ Secure the transmitter against falling during transport. Wear the required personal protective equipment. Observe the applicable rules.

5.1 Transport

The measuring equipment must be packaged properly for transport, see section 2.7. For weight indications of the transmitter and the transducers, see technical specification.

5.2 Storage

The transmitter and the transducers have to be stored in a dry place.

6 Installation

Caution!



Touching hot or cold surfaces

This may result in injuries (e.g., thermal damages).

→ Observe the ambient conditions at the measuring point during installation. Wear the required personal protective equipment. Observe the applicable rules.

6.1 Transmitter

6.1.1 Transmitter structure

The command panel can be accessed by opening the cover.

Fig. 6.1: Command panel of the transmitter

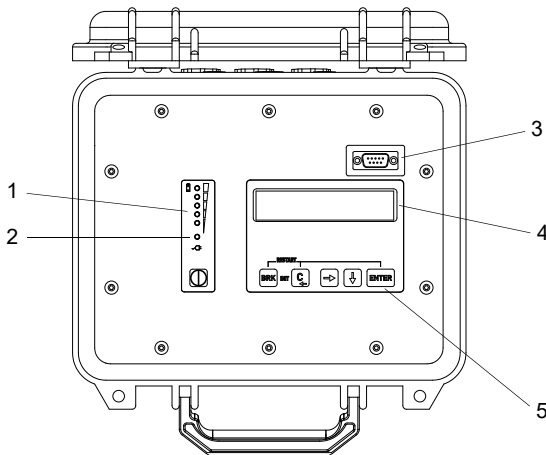

- 1 – status indicator "charge state"
- 2 – status indicator "power supply"
- 3 – RS232 service interface
- 4 – 2 × 16 digit LCD display, backlight
- 5 – keyboard

Fig. 6.2: Connections on the transmitter

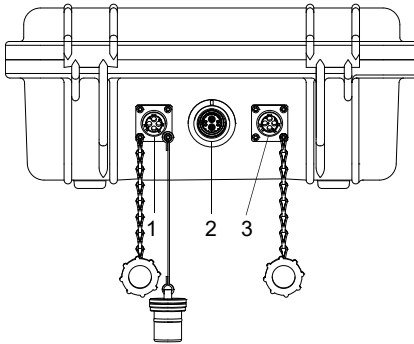

- 1 – output
- 2 – transducers
- 3 – power supply

6.2 Transducers

6.2.1 Preparation

6.2.1.1 Measuring point selection

The correct selection of the measuring point is crucial for achieving reliable measurement results and a high measurement accuracy.

A measurement on a pipe is possible if:

- the ultrasound propagates with a sufficiently high amplitude
- the flow profile is fully developed

The correct selection of the measuring point and the correct transducer positioning guarantee that the sound signal will be received under optimum conditions and evaluated correctly.

Because of the variety of applications and the different factors that influence the measurement, there is no standard solution for the transducer positioning.

The measurement is influenced by the following factors:

- diameter, material, lining, wall thickness and shape of the pipe
- fluid
- gas bubbles in the fluid

- Avoid measuring points in the vicinity of distorted or defective areas of the pipe or in the vicinity of welds.
- Avoid measuring points with deposit formation in the pipe.
- Make sure the pipe surface at the selected measuring point is even.
- Select the location of the transmitter within the transducer cable range.
- The ambient temperature at the measuring point has to be within the operating temperature range of the transmitter and the transducers, see technical specification.

6.2.1.2 Pipe preparation

Caution!



Contact with grinding dust

This may result in injuries (e.g., breathing difficulties, skin reactions, eye irritations).

→ Wear the required personal protective equipment. Observe the applicable rules.

Important!

The pipe has to be sufficiently stable to withstand the pressure exerted by the transducers and the tension straps.

Notice!

Observe the selection criteria of pipe and measuring point.

Rust, paint or deposits on the pipe absorb the sound signal. A good acoustic contact between the pipe and the transducers is obtained as follows:

- Clean the pipe at the selected measuring point.
 - If present, the paint layer has to be smoothed by grinding. The paint does not need to be removed completely.
 - Remove rust or loose paint.
- Use coupling foil or apply a bead of acoustic coupling compound along the center line of the contact surface of the transducers.
- Observe that there must be no air pockets between the transducer contact surface and the pipe wall.

6.2.1.3 Selection of the measurement arrangement

Diagonal arrangement with 1 beam

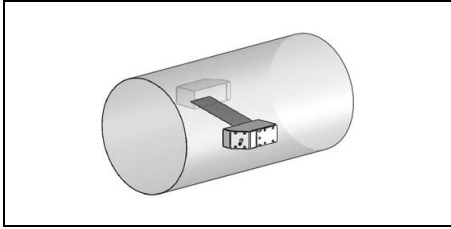

- wider flow velocity and sound speed range compared to the reflection arrangement
- use in the presence of deposits on the inner pipe wall or with strongly attenuating gases or liquids (only 1 sound path)

Reflection arrangement with 1 beam

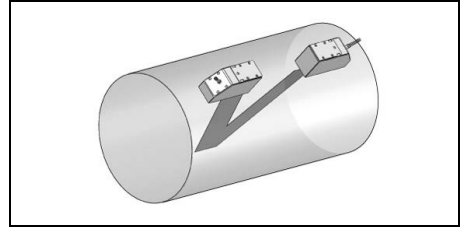

- smaller flow velocity and sound speed range compared to the diagonal arrangement
- transverse flow effects are compensated because the beam crosses the pipe in 2 directions
- higher accuracy of measurement because the accuracy increases with the number of sound paths

If the measuring point is situated near an elbow, the following measurement arrangements are recommended for the selection of the sound beam plane.

Vertical pipes

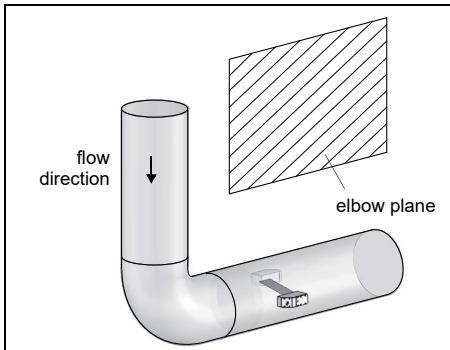

- The sound beam plan is selected in an angle of 90° to the elbow plane. The elbow is upstream of the measuring point.

Horizontal pipes

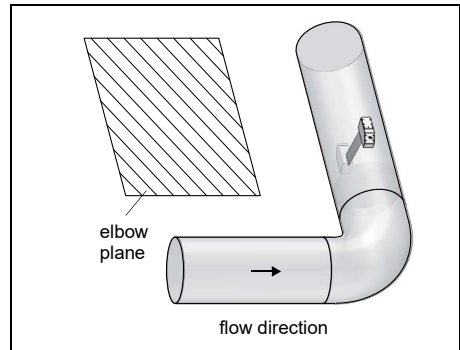

- The sound beam plane is selected in an angle of $90^\circ \pm 45^\circ$ to the elbow plane. The elbow is upstream of the measuring point.

Bidirectional measurements

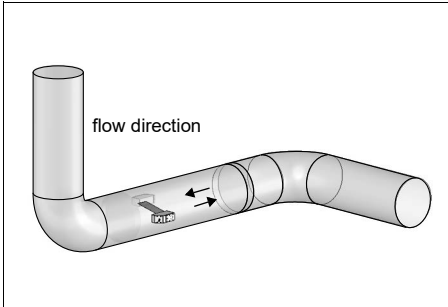

- The sound beam plane is selected according to the nearest elbow (horizontal or vertical, depending on the pipe orientation, see above).

6.2.2 Installation of the transducers

6.2.2.1 Orientation of the transducers and determination of the transducer distance

Observe the orientation of the transducers. If the transducers have been mounted properly, the engravings on the transducers form an arrow, see Fig. 6.3. The transducer cables show in opposite directions.

The transducer distance is measured between the inner edges of the transducers.

Fig. 6.3: Orientation of the transducers and transducer distance

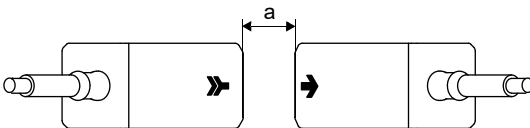

a – transducer distance

- Select the installation instructions that correspond to the supplied transducer mounting fixture.

6.2.2.2 Mounting of the transducers with transducer clamping fixture and ladder chains

- Insert the transducer into the transducer clamping fixture until it snaps.
- Fix the chain to the hook of the transducer clamping fixture.
- Place the transducer clamping fixture onto the pipe.
- Place the chain around the pipe and fix it into the hook on the opposite side of the transducer clamping fixture.
- Fix the transducer tightly on the pipe using the tensioning screw of the transducer clamping fixture.
- Fix the second transducer the same way.

Fig. 6.4: Mounting the transducers with transducer clamping fixture and ladder chain

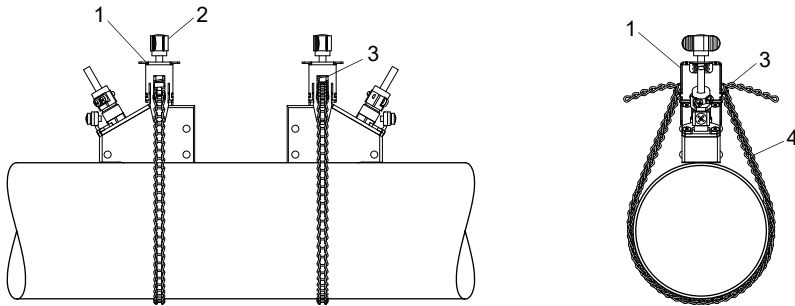

- 1 – transducer clamping fixture
- 2 – tensioning screw
- 3 – hooks
- 4 – ladder chain

6.2.2.3 Mounting of the transducers with transducer shoes and ball chains

- Insert the transducer into the transducer shoe. Turn the screw on top of the fastening shoe by 90° to engage and lock its end in the groove on top of the inserted transducer.
- Place the transducer shoe on the pipe. Insert the last ball into the slot on the upper side of one of the transducer shoe.
- Place the chain around the pipe.
- Tighten the chain and insert it into the other slot of the transducer shoe.
- Fix the second transducer the same way.

Fig. 6.5: Mounting of the transducers with transducer shoes and ball chains

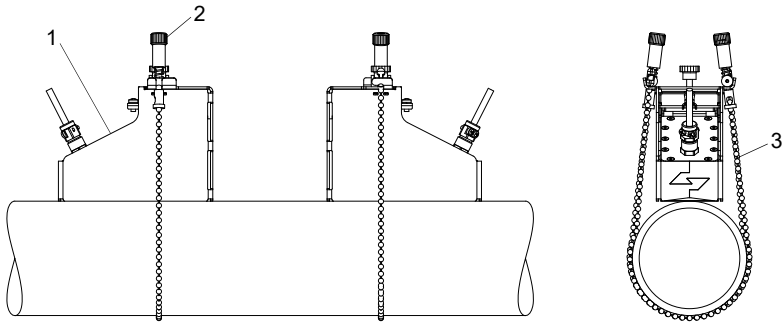

- 1 – transducer shoe
2 – screw
3 – ball chain

To ensure the correct transducer distance, the material thickness (2 mm) of the transducer shoes has to be added.

Notice!

transducer distance = distance between transducer shoes + 2 x 2 mm

Extension of the ball chain

In order to extend the chain, insert the last ball of the extension into the fastening clip of the ball chain. The spare fastening clips supplied with the chain can be used to repair a broken chain.

6.2.2.4 Mounting of the transducers with transducer shoes and ladder chains

- Adjust the transducer distance on the ruler before installation of the transducer shoes.
- Place the transducer shoes on the pipe.
- Loosen the knurled screw.
- Place the chain around the pipe.
- Tighten the chain and insert it into the hook of the transducer shoe.
- Tension the chain by tightening the knurled screw.
- Fix the second transducer shoe in the same way.
- Insert the transducer into the transducer shoe.
- Tighten the screw on the upper side of the transducer shoe in order to fix the transducer on the pipe.
- Fix the second transducer in the same way.
- Read the transducer distance from the ruler.

Fig. 6.6: Mounting of the transducers with transducer shoes and ladder chains

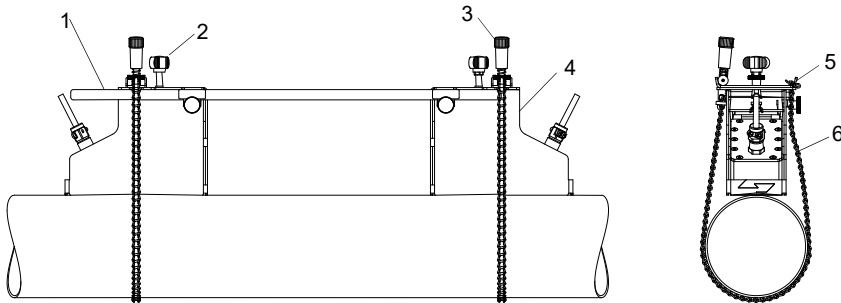

- 1 – ruler
- 2 – screw
- 3 – knurled nut
- 4 – transducer shoe
- 5 – hooks
- 6 – ladder chain

7 Connection

The connections of the outputs, transducers and the power supply unit are located on the rear side of the transmitter, see Fig. 7.1.

Fig. 7.1: Connections on the transmitter

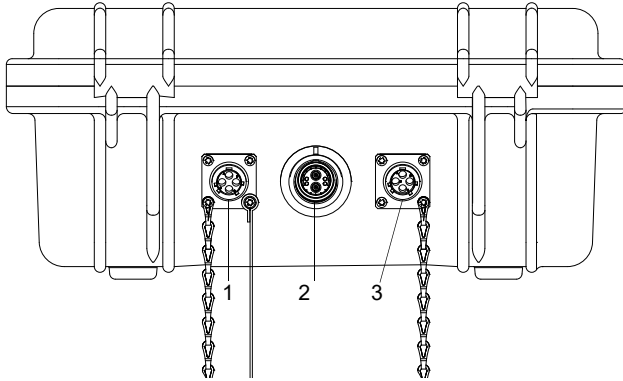

- 1 – outputs
- 2 – transducers
- 3 – power supply unit/battery charging unit

7.1 Transducers

It is recommended to run the cables from the measuring point to the transmitter before connecting the transducers to avoid load on the connectors.

Connection

- Remove the protective cap from the transmitter.
- Remove the protective cap from the transducer. Pull the knurled ring slightly back.
- Insert the connector into the transmitter socket. The red point on the connector has to be aligned with the red marking on the socket.

Fig. 7.2: Transducer connector

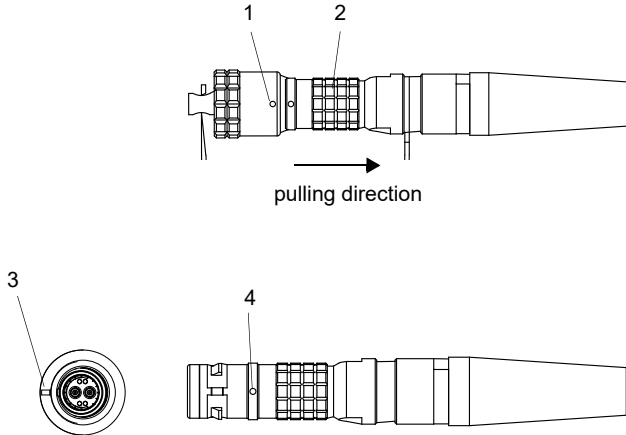

- 1 – protective cap with marking
- 2 – knurled ring
- 3 – marking on the transmitter socket
- 4 – marking on the connector

Removal

- Pull the knurled ring slightly back and remove the connector from the transmitter socket.
- Put the protective cap on the connector. The red point on the connector has to be aligned with the red marking on the protective cap.
- Put the protective cap on the transmitter socket.

7.2 Power supply

The transmitter can be operated with the integrated battery, the power supply unit or the power pack PP026NN, see document QSPowerPack_PP026.

7.2.1 Battery operation

The transmitter has a Li-ion battery and can therefore be operated independently. When delivered, the battery is charged with approx. 30 %. The battery does not need to be fully charged before it is used for the first time.

If the LED of the status indicator "power supply" flashes red the battery is almost empty. The capacity is sufficient for storing of the current parameter record. A measurement is impossible.

Notice!

It is recommended to discharge and subsequently recharge the batteries completely for at least once a year.

Charging the battery

Connect the power supply to the transmitter, see section 7.2.2. Switch on the transmitter. The charging starts automatically. The green LED flashes. The max. charging time is approx. 8 h. During the charging process, the ambient temperature should be in the range of 0...45 °C.

A measurement can be made during the charging. Charging will be stopped automatically when the battery is fully charged. The LED will light green.

Notice!

The battery will only be charged if the transmitter is switched on.

Optionally, the transmitter can be charged with a car adapter via the 12 V connector.

Battery storage

The battery remains in the transmitter. After storage, the transmitter can immediately be operated with the battery.

- battery charge: > 30 %
- storing temperature: 12...25 °C

7.2.2 Power supply operation

Connection

- Remove the protective cap on the transmitter by turning it to the left.
- Insert the connector into the transmitter socket.
- Turn the knurled ring to the right in order to fix the connector.

Fig. 7.3: Connector on the output adapter/power supply unit

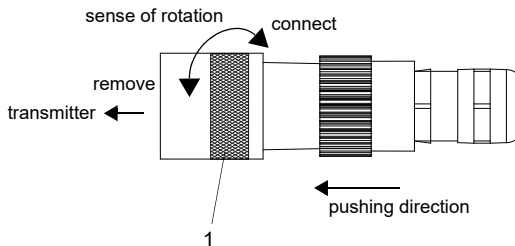

1 – knurled ring

Removal

- Push the connector firmly toward the transmitter. Turn the knurled ring to the left and remove the connector from the transmitter socket.
- Screw the protective cap on the socket. Turn protective cap to the right in order to fix it.

Important!

- Use only the supplied power supply unit.
- The power supply is not protected against moisture. Use it only in dry rooms.
- The voltage indicated on the power supply unit must not be exceeded.
- Do not connect a defective power supply unit to the transmitter.

7.3 Outputs

Tab. 7.1: Circuit of the outputs

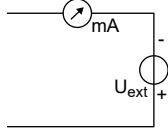
output	transmitter		external circuit	remark
	internal circuit	connection		
passive current output		C(+) D(-)		$U_{\text{ext}} = 4 \dots 24 \text{ V}$ $U_{\text{ext}} > 0.022 \text{ A} \cdot R_{\text{ext}} [\Omega] + 4 \text{ V}$ example: $U_{\text{ext}} = 6 \text{ V}$ $R_{\text{ext}} \leq 90 \Omega$

R_{ext} is the sum of all ohmic resistances in the circuit (e.g., resistance of the conductors, resistance of the amperemeter/voltmeter).

Tab. 7.1: Circuit of the outputs

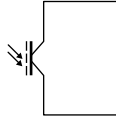
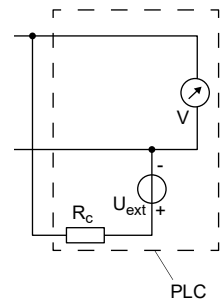
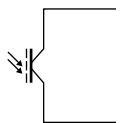
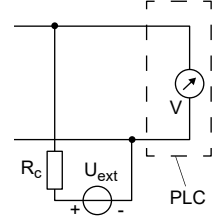
output	transmitter		external circuit	remark
	internal circuit	connection		
binary output (opto-relay)	circuit 1			$U_{ext} = 32\text{ V}$ $I_c \leq 200\text{ mA}$ $R_c [\text{k}\Omega] = U_{ext}/I_c [\text{mA}]$
		A(+) B(-)		
	circuit 2			
		A(+) B(-)		

R_{ext} is the sum of all ohmic resistances in the circuit (e.g., resistance of the conductors, resistance of the amperemeter/voltmeter).

Fig. 7.4: Terminal assignment for the connection of the outputs

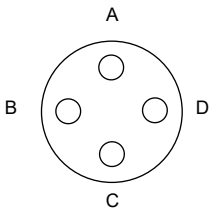

Output adapter (optional)

Fig. 7.5: Output adapter

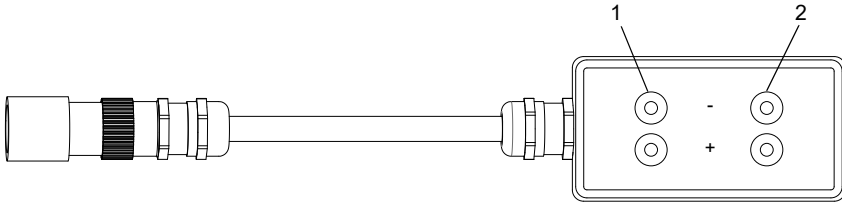

- 1 – binary output
- 2 – current output

Connection

- Remove the protective cap on the transmitter by turning it to the left.
- Insert the connector into the transmitter socket.
- Turn the knurled ring to the right in order to fix the connector.

Fig. 7.6: Connector on the output adapter/power supply unit

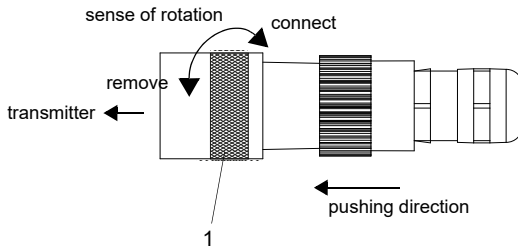

- 1 – knurled ring

Removal

- Push the connector firmly toward the transmitter. Turn the knurled ring to the left and remove the connector from the transmitter socket.
- Screw the protective cap on the socket. Turn protective cap to the right in order to fix it.

7.4 Connection of the RS232 service interface

The RS232 service interface is located on the front plate of the transmitter, see Fig. 6.1.

- Connect the RS232 cable to the transmitter and the serial interface of the PC. If the RS232 cable cannot be connected to the PC, use the RS232/USB adapter.

8 Start-up

8.1 Start-up settings

When starting up the transmitter for the first time, the following settings are required:

- language
- units of measurement
- date/time

These displays will only be indicated once when the transmitter is switched on for the first time.

Select language

The available transmitter languages are displayed.

- Select a language.
- Press ENTER.

The menus are displayed in the selected language.

Engineer. Units

- Select metric or imperial.
- Press ENTER.



CANADA-REGION

- Select `yes` if the transmitter is to be used in the region of Canada.
- Press ENTER.

This display will only be indicated if `imperial` is selected.



TIME

The current time is displayed.

- Press ENTER to confirm the time or to set the current time via the keys  and .
- Press ENTER.

DATE

The current date is displayed.

- Press ENTER to confirm the date or to set the current date via the keys  and .
- Press ENTER.

8.2 Switching on/off

Press key I/O to switch on the transmitter.

As soon as the transmitter is switched on, the serial number of the transmitter is displayed for a short time. It is not possible to enter any data while the serial number is displayed.

Afterwards, the main menu is displayed in the default language. The language of the display can be set, see section 8.4.

Press key I/O 3 times to switch off the transmitter.

8.3 Program branches

The following schema shows the program branches. For a detailed overview of the menu structure see annex A.

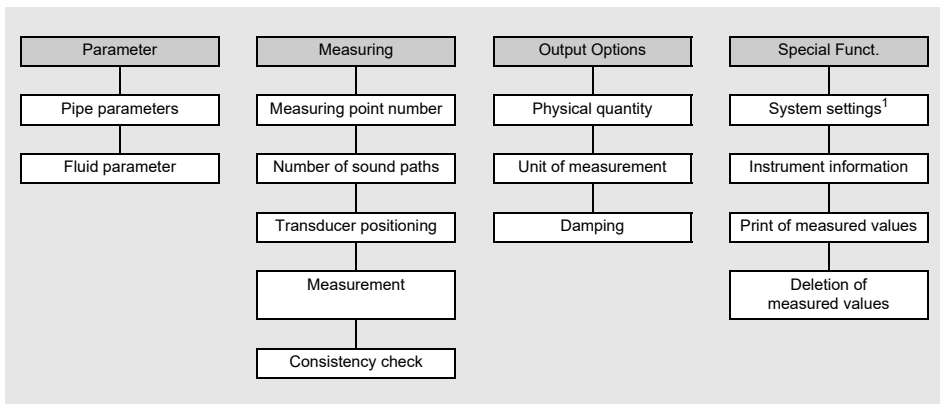

¹ `SYSTEM` settings contains the following menu items:

- dialogs and menus
- measurement
- outputs
- storing
- signal snap
- serial transmission
- miscellaneous
- clock settings

8.4 HotCodes

A HotCode is a digit sequence that activates certain functions and settings.

```
Special Funct.\SYSTEM settings\Miscellaneous
```

- Select the menu item `Miscellaneous` in the program branch `Special Funct.\SYSTEM settings`.
- Press `ENTER`.

```
Input a HOTCODE
```

- Select `yes` to enter a HotCode.
- Press `ENTER`.

```
Please input a HOTCODE: 000000
```

- Enter the HotCode.
- Press `ENTER`.
- The error message `INVALID HOTCODE` will be displayed if an invalid HotCode has been entered.
- Press `ENTER`.

```
Input a HOTCODE
```

- Select `yes` to enter the HotCode again or `no` to return to the menu item `Miscellaneous`.
- Press `ENTER`.

function	HotCode
reset of the display to medium contrast	555000
language	9090xx
activation/deactivation of the SuperUser mode	071049
change transmission parameters of RS232 service interface	232-0-

8.5 Language

The language can be selected with the following HotCodes:

language	HotCode
Dutch	909031
French	909033
Spanish	909034
English	909044
German	909049

When the last digit has been entered, the main menu is displayed in the selected language.

The selected language remains activated when the transmitter is switched off and on again. After an initialization of the transmitter, the language is reset to the default language.

8.6 Initialization

During an initialization (INIT) of the transmitter, the settings in the program branches `Parameter` and `Output Options` and some of the settings in the program branch `Special Funct.` are reset to the default settings of the manufacturer.

Proceed as follows to execute an initialization:

- When switching on the transmitter: keep keys BRK and C pressed.
- During the operation of the transmitter: press keys BRK, C and ENTER at the same time. A reset is executed. Release only key ENTER. Keep keys BRK and C pressed.

After the initialization has been executed, the message `INITIALISATION DONE` is displayed.

After the initialization, the remaining settings of the transmitter can be reset to the default settings and/or the stored measured values can be deleted.

FACTORY DEFAULT

- Select `yes` to reset the remaining settings of the transmitter to default settings or `no` to keep them at the current settings.
- Press ENTER.

If `yes` is selected, the message `FACTORY DEFAULT DONE` will be displayed.

```
Delete Meas.Val.
```

- Select `yes` to delete the stored measured values or `no` to keep them.
- Press ENTER.

This display will only be indicated if measured values are stored in the transmitter.



8.7 Time and date

The transmitter has a battery-powered clock. Measured values are automatically stored with date and time.

```
Special Funct.\SYSTEM settings\Set Clock\TIME
```

- Select the menu item `Set Clock`.
- Press ENTER.

The current time is displayed.



- Select `ok` to confirm the time or `new` to adjust it.
- Press ENTER.
- Select the character to be edited with key . Edit the selected character with key .
- Press ENTER.

The new time is displayed.

- Select `ok` to confirm the time or `new` to adjust it again.
- Press ENTER.

```
Special Funct.\SYSTEM settings\Set Clock\DATE
```

After the time has been set, the date is displayed.

- Select `ok` to confirm the date or `new` to adjust it.
- Press ENTER.
- Select the character to be edited with key . Edit the selected character with key .
- Press ENTER.

The new date is displayed.

- Select `ok` to confirm the date or `new` to adjust it again.
- Press ENTER.

8.8 Instrument information

```
Special Funct.\Instrum. Inform.
```

- Select the menu item `Instrum. Inform.` to get information about the transmitter.
- Press ENTER.

```
F401      -XXXXXXXX
```

The type and the serial number of the transmitter are displayed in the upper line.

```
Free:      18327
```

The max. available data logger will be displayed in the lower line (here: 18327 additional measured values can be stored).

- Press ENTER.

```
V x.xx    dd.mm.yy
```

The firmware version of the transmitter is displayed with the date in the lower line.

- Press ENTER.

9 Measurement

9.1 Parameter input

Notice!

The parameters will only be stored when the program branch `Parameter` has been edited in its entirety.

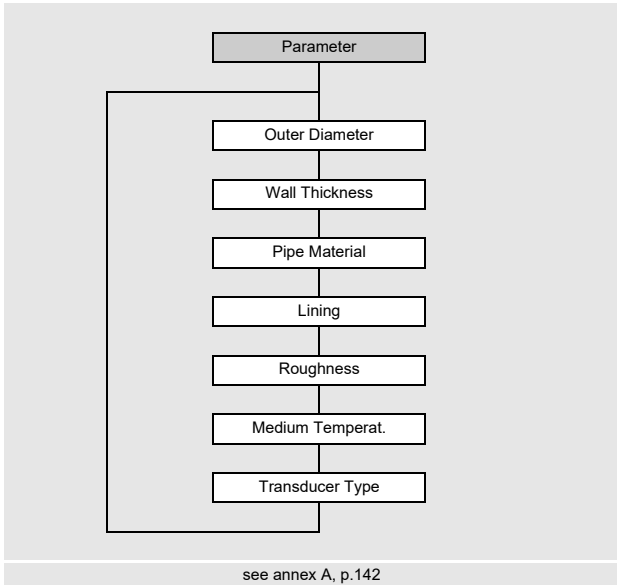

The pipe and fluid parameters are entered for the selected measuring point. The parameter ranges are limited by the technical characteristics of the transducers and the transmitter.

- Select the program branch `Parameter`.
- Press ENTER.

9.1.1 Input of pipe parameters

Outer pipe diameter/pipe circumference

Parameter\Outer Diameter

- Enter the outer pipe diameter.
- Press ENTER.

An error message will be displayed if the entered parameter is outside the range. The limit is displayed.

Example: upper limit 1100 mm for the connected transducers and for a pipe wall thickness of 50 mm.

Outer Diameter
1100.0 MAXIMAL

It is possible to enter the pipe circumference instead of the outer pipe diameter, see section 18.1).

If the input of the pipe circumference is activated and zero is entered in `Outer Diameter`, the menu item `Pipe Circumfer.` will be displayed. If the pipe circumference is not to be entered, press key BRK to return to the main menu and start the parameter input again.

Notice!

The inner pipe diameter (= outer pipe diameter - 2 × pipe wall thickness) will be calculated internally.

If the value is not within the inner pipe diameter range of the connected transducers, an error message will be displayed.

Pipe wall thickness

Parameter\Wall Thickness

- Enter the pipe wall thickness.
- Press ENTER.

Pipe material

```
Parameter\Pipe Material
```

The pipe material has to be selected to be able to determine the corresponding sound speed.

The sound speeds for the materials in the scroll list are stored in the transmitter.

- Select the pipe material.
- Press ENTER.
- If the material is not in the scroll list, select `Other Material`.
- Press ENTER.

Sound speed of the pipe material

```
Parameter\Pipe Material\Other Material\c-Material
```

- Enter the sound speed of the pipe material.
- Press ENTER.

Notice!

There are 2 sound speeds for pipe materials, the longitudinal and the transversal one. Enter the sound speed which is nearer to 2500 m/s.

These displays will only be indicated if `Other Material` is selected.

For the sound speed of some materials, see annex C.

Lining

```
Parameter\Lining
```

- Select `yes` if the pipe has a lining. Select `no` if the pipe has no lining.
- Press ENTER.

Lining material

```
Parameter\Lining
```

- Select the lining material.
- Press ENTER.
- If the lining material is not included in the scroll list, select `Other Material`.
- Press ENTER.

This display will only be indicated if `yes` is selected in the menu item `Lining`.

Sound speed of the lining material

Parameter\Lining\Other Material\c-Material

- Enter the sound speed of the lining material.
- Press ENTER.

Notice!

For pipe materials there are 2 sound speeds, the longitudinal and the transversal one. Enter the sound speed which is nearer to 2500 m/s.

These displays will only be indicated if `Other Material` is selected.

Lining thickness

Parameter\Liner Thickness

- Enter the thickness of the lining.
- Press ENTER.

This display will only be indicated if `yes` is selected in the menu item `Lining`.

Pipe roughness

Parameter\Roughness

The flow profile of the fluid is influenced by the roughness of the inner pipe wall.

The roughness is used for the calculation of the profile correction factor.

In most cases, the pipe roughness cannot be exactly determined and must therefore be estimated.

For the roughness of some materials, see annex C.

- Enter the roughness for the selected pipe or lining material.
- Change the value according to the condition of the inner pipe wall.
- Press ENTER.

Input of the disturbance distance

Parameter\Disturb.distance

- Enter the disturbance distance.
- Press ENTER.

This display will only be indicated if `With disturbance` is selected in the menu item `Special Funct.\SYSTEM settings\Measuring\ProfileCorr 2.0`.

9.1.2 Input of fluid parameters

Fluid temperature

```
Parameter\Medium Temperat.
```

At the beginning of the measurement, the fluid temperature is used for the interpolation of the sound speed and therefore for the calculation of the recommended transducer distance.

During the measurement, the fluid temperature is used for the interpolation of the density and viscosity of the fluid.

The value entered here is used for the calculation if the fluid temperature is not measured.

- Enter the fluid temperature. The value has to be within the operating temperature of the transducers.
- Press ENTER.

9.1.3 Selection of the transducer

The transducer type has to be selected.

```
Parameter\Transducer Type
```

- Select `Standard` to use the standard transducer parameters stored in the transmitter.
- Press ENTER.

```
Transducer      ↓
CLAMPON 2MHZ
```

- Select the transducer frequency of the used transducer (see nameplate).
- Press ENTER.

9.2 Measurement settings

9.2.1 Selection of the physical quantity and the unit of measurement

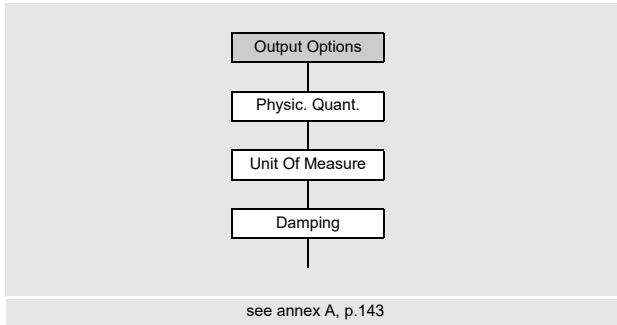

The following physical quantities can be measured:

- sound speed
- flow velocity: is calculated on the basis of the measured transit time difference
- volumetric flow rate: is calculated by multiplying the flow velocity by the cross-sectional pipe area
- mass flow rate: is calculated by multiplying the volumetric flow rate by the operating density of the fluid

The physical quantity is selected as follows:

- Select the program branch `Output Options`.
- Press ENTER.

```
Output Options\Physic. Quant.
```

- Select the physical quantity in the scroll list.
- Press ENTER.

```
Output Options\Physic. Quant.\Volume flow
```

For the selected physical quantity (except for the sound speed), a scroll list with the available units of measurement is displayed. The unit of measurement which was selected previously is displayed first.

- Select the unit of measurement of the selected physical quantity.
- Press ENTER.

Notice!

If the physical quantity or the unit of measurement is changed, the settings of the outputs have to be checked, see section 9.2.3.

9.2.2 Input of the damping factor

Each displayed measured value is a floating average of all measured values of the last x seconds, with x being the damping factor. A damping factor of 1 s means that the measured values are not averaged because the measuring rate is approx 1/s. The default value of 10 s is appropriate for normal flow conditions. Values which fluctuate strongly due to a higher flow dynamic, require a higher damping factor.

Output Options\...\Damping

- Select the program branch `Output Options`.
- Press ENTER until the menu item `Damping` is displayed.
- Enter the damping factor.
- Press ENTER.
- Press key BRK to return to the main menu.

Notice!

While the low-power mode is activated, the damping factor is max. 4 s.

9.2.3 Installation of an output

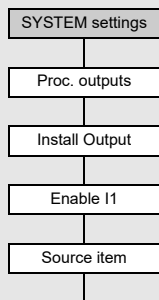

see annex A, p.146

If the transmitter is equipped with outputs, they have to be installed and activated before they can be used:

- assignment of the physical quantity (source item) to be transmitted to the output by the source channel, and the properties of the signal
- definition of the output behavior in case no valid measured values are available
- activation of the installed output in the program branch `Output Options`

Notice!

The settings will be stored at the end of the dialog. If the menu item is quit by pressing key BRK, the changes will not be stored.

```
Special Funct.\SYSTEM settings\Proc. outputs
```

- Select Special Funct.\SYSTEM settings\Proc. outputs.
- Press ENTER.

Selection of an output

```
Special Funct.\SYSTEM settings\Proc. outputs\Install Output
```

- Select the output to be installed.
- Press ENTER.

The scroll list contains all available outputs of the transmitter:

- Current Ix (--)
- Binary Bx (--)

A tick (✓) after a list item indicates that this output has already been installed.

```
Special Funct.\SYSTEM settings\Proc. outputs\Enable I1
```

- Select **yes** to install or reconfigure the output.
- Press ENTER.
- Select **no** to uninstall the output and to return to the previous menu item in order to select another output.
- Press ENTER.

Assignment of a source item

One source item has to be assigned to each selected output.

```
Special Funct.\SYSTEM settings\Proc. outputs\...\Source item
```

- Select the physical quantity (source item) to be transmitted to the output by the source channel.
- Press ENTER.

If a binary output is configured, only the list items `Limit` and `Impuls` will be displayed.

The source items and their scroll lists are summarized in the Tab. 9.1.

Tab. 9.1: Configuration of the outputs

source item	list item	output
Measuring value	-	physical quantity selected in the program branch Output Options
Quantity	Q+	totalizer for the positive flow direction
	Q-	totalizer for the negative flow direction
	ΣQ	sum of the totalizers (positive and negative flow direction)
Limit	R1	limit message (Alarm Output R1)
Impuls	from abs(x)	pulse without sign consideration
	from x > 0	pulse for positive measured values
	from x < 0	pulse for negative measured values
Miscellaneous	c-Medium	fluid sound speed
	SCNR	ratio useful signal to correlated noise signal
	Signal	signal amplitude of a measuring channel
	VariAmp	standard deviation of the signal amplitude
	Density	density of the fluid
	Pressure	pressure of the fluid

9.2.3.1 Output of the measured value

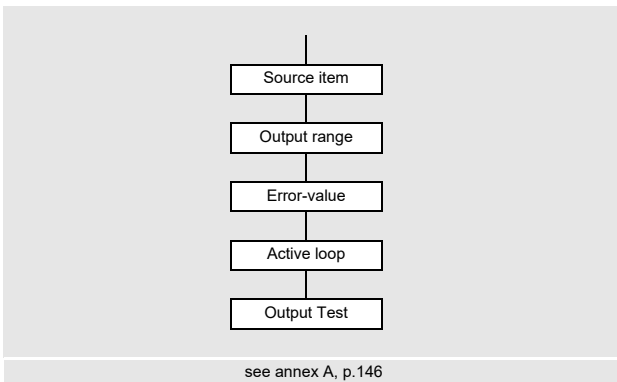

Output range

When configuring an analog output, the output range has to be defined.

```
Special Funct.\SYSTEM settings\Proc. outputs\...\Output range I1
```

- Select `Special Funct.\SYSTEM settings\Proc. outputs\...\Output range I1`.
- Press ENTER.
- Select a list item.
 - 4/20 mA
 - other range...
- Press ENTER.
- If `other range` is selected, enter the values `Output MIN` and `Output MAX`.
- Press ENTER after each input.

Error output

```
Special Funct.\SYSTEM settings\Proc. outputs\...\Error-value I1
```

In the following dialog, an error value can be defined which is to be transmitted if the source item cannot be measured, e.g., if there are solids in the fluid.

- Select a list item for the error output, see Tab. 9.2.
- Press ENTER.
- If `Other value...` is selected, enter an error value. The value has to be within the output range.
- Press ENTER.

Notice!

The settings will be stored at the end of the dialog.

Tab. 9.2: Error output

error value	result
Minimum	the lower limit of the output range is output
Hold last value	the last measured value is output
Maximum	the upper limit of the output range is output
Other value...	The value has to be entered manually. It has to be within the limits of the output.

Example

source item: volumetric flow rate
 output: current output
 output range: 4...20 mA

error delay: $t_d > 0$

(see section 9.2.5 and Tab. 9.3)

The volumetric flow rate cannot be measured during the time interval $t_0...t_1$. The error value will be output.

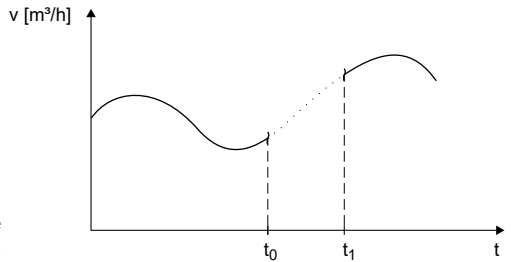

Tab. 9.3: Examples for the error output (output range: 4...20 mA)

list item	output signal
Minimum (4.0 mA)	

Tab. 9.3: Examples for the error output (output range: 4...20 mA)

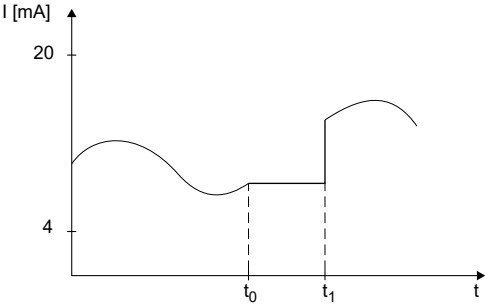
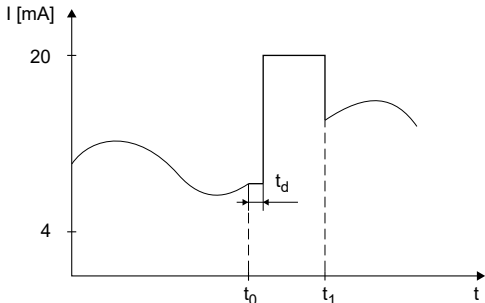
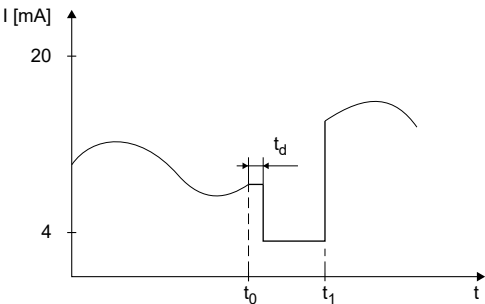
list item	output signal
Hold last value	 <p>The graph shows current I [mA] on the y-axis (0 to 20) and time t on the x-axis. A sinusoidal wave starts at approximately 10 mA. At time t_0, the signal drops to a constant value of about 10 mA. At time t_1, it jumps to a higher constant value of about 15 mA. The signal then follows a sinusoidal wave again.</p>
Maximum (20.0 mA)	 <p>The graph shows current I [mA] on the y-axis (0 to 20) and time t on the x-axis. A sinusoidal wave starts at approximately 10 mA. At time t_0, the signal drops to a constant value of about 10 mA. At time t_1, it jumps to a constant value of 20 mA. The signal then follows a sinusoidal wave again. A delay time t_d is indicated between t_0 and t_1.</p>
Other value... error value = 3.5 mA	 <p>The graph shows current I [mA] on the y-axis (0 to 20) and time t on the x-axis. A sinusoidal wave starts at approximately 10 mA. At time t_0, the signal drops to a constant value of about 10 mA. At time t_1, it jumps to a constant value of 3.5 mA. The signal then follows a sinusoidal wave again. A delay time t_d is indicated between t_0 and t_1.</p>

Terminal assignment

```
Special Funct.\SYSTEM settings\Proc. outputs\...\Active loop I1
```

The terminals for the connection of the output are displayed.

- Press ENTER.

If the transmitter possesses a switchable current output, it is displayed whether it is active or passive (here: active).

Output function test

The function of the output can now be tested.

- Connect an external measuring instrument to the terminals of the output.

```
Special Funct.\SYSTEM settings\Proc. outputs\...\Output Test I1
```

- Enter a test value. It has to be within the output range.
- Press ENTER.

```
Special Funct.\SYSTEM settings\Proc. outputs\...\I1= 10 mA\  
Again?
```

If the external measuring instrument displays the entered value, the output functions correctly.

- Select *yes* to repeat the test, *no* to return to the menu item `SYSTEM settings`.
- Press ENTER.

9.2.4 Activation of an analog output

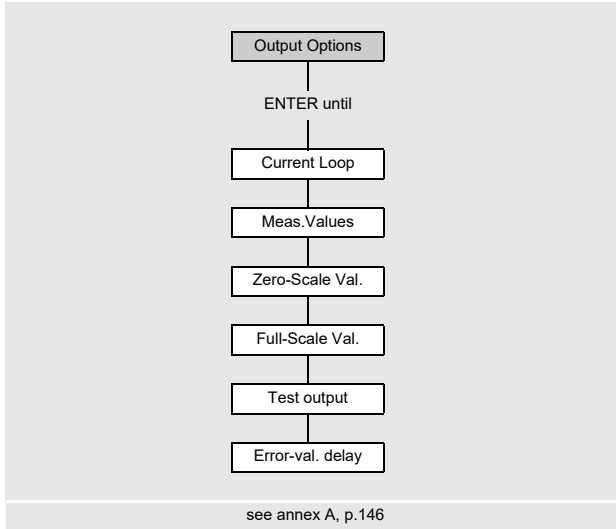

Notice!

An output can only be activated in the program branch `Output Options` if it has previously been installed.

The measuring range of the source item has to be entered.

`Output Options\...\Current Loop`

- Press ENTER until `Current Loop` is displayed. Select `yes` to activate the output.
- Press ENTER.

Measuring range

After an analog output has been activated in the program branch `Output Options`, the measuring range of the source item has to be entered.

`Output Options\...\Meas.Values`

- Select `sign` if the sign of the measured values is to be considered for the output.
- Select `absolut` if the sign of the measured values is not to be considered for the output.
- Press ENTER.

```
Output Options\...\Zero-Scale Val.
```

- Enter the lowest expected measured value. The unit of measurement of the source item will be displayed.

Zero-Scale Val. is the value assigned to the value Output MIN of the output range.

- Press ENTER.

```
Output Options\...\Full-Scale Val.
```

- Enter the highest expected measured value. The unit of measurement of the source item will be displayed.

Full-Scale Val. is the value assigned to the value Output MAX of the output range.

- Press ENTER.

Example

output: current output

output range: 4...20 mA

Zero-Scale Val.: 0 m³/h

Full-Scale Val.: 300 m³/h

volumetric flow rate = 0 m³/h, corresponds to 4 mA

volumetric flow rate = 300 m³/h, corresponds to 20 mA

Function test

The function of the output can now be tested.

- Connect an external measuring instrument to the terminals of the output.

```
Output Options\...\I1:Test output?
```

- Select *yes* to test the output.
- Press ENTER.

```
Output Options\...\I1:Test value
```

- Enter a test value for the selected physical quantity. If the external measuring instrument displays the entered value, the output functions correctly.
- Press ENTER.

```
Output Options\...\I1:Test output?
```

- Select **yes** to repeat the test.
- Press **ENTER**.

Example

output: current output

output range: 4...20 mA

Zero-Scale Val.: 0 m³/h

Full-Scale Val.: 300 m³/h

Test value = 150 m³/h (center of the measuring range, corresponds to 12 mA)

If the multimeter displays 12 mA, the current output functions correctly.

9.2.5 Input of the error delay

The error delay is the time after which an error value will be sent to an output if no valid measured values are available.

```
Output Options\...\I1:Error-val. delay
```

This display will only be indicated if the list item **edit** is selected in **Special Funct.\Dialogs/Menus/Error-val. delay**.

If the error delay is not entered, the damping factor will be used.

- Enter a value for the error delay.
- Press **ENTER**.

9.3 Start of the measurement

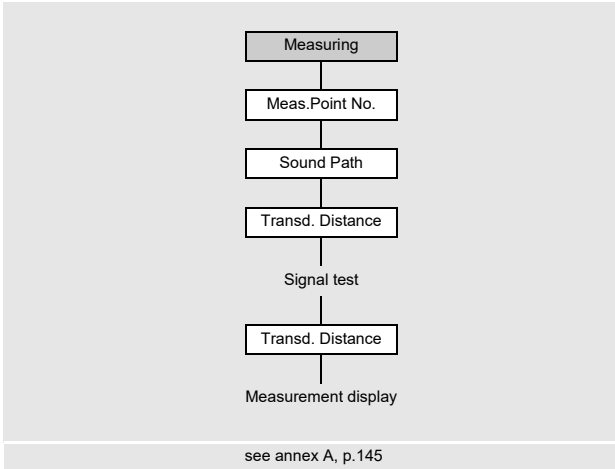

- Select the program branch `Measuring`.
- Press ENTER.

If the parameters in the program branch `Parameter` are not valid or incomplete, the error message `NO DATA!` will be displayed.

Input of the measuring point number

```
Measuring\Channel\Meas.Point No.
```

- Enter the number of the measuring point.
- Press ENTER.

For the activation of text input, see `Special Funct.\SYSTEM settings\Dialogs/ Menus\Meas.Point No.`

Notice!

If the NoiseTrek parallel beam mode is enabled, it will be displayed and the measurement is immediately started.

Input of the sound path number

```
Measuring\Channel\...\Sound Path
```

A value for the number of sound paths corresponding to the connected transducers and the entered parameters is recommended.

- Change the value, if necessary.
- Press ENTER.

Profile correction

If **With disturbance** is selected in the menu item `Special Funct.\SYSTEM settings\Measuring\ProfileCorr 2.0`, it has to be checked whether the measurement arrangement is appropriate.

If the number of sound paths is odd and more than one measuring channel is activated, the following display appears:

```
A: Alone at measp
>NO<           yes
```

- Select `no` if there are 2 transducer pairs in X arrangement or displaced X arrangement at the measuring point (appropriate measurement arrangement). The profile correction 2.0 at non ideal inflow conditions will be used. Transverse flow effects will be compensated.
- Select `yes` if there is only one transducer pair at the measuring point (inappropriate measurement arrangement). The profile correction 2.0 at non ideal inflow conditions cannot be used. The profile correction 2.0 at ideal inflow conditions will be used. Transverse flow effects will not be compensated.
- Press ENTER.

If `yes` is selected, the following menu messages are displayed:

```
Disturb correct.
not applicable!
```

```
I assume ideal
inlet conditions
```

Adjustment of the transducer distance

Measuring\...\Transd. Distance

The recommended transducer distance will be displayed.

- Mount the transducers on the pipe adjusting the transducer distance.
- Press ENTER.

Reflec – reflection arrangement

Diagon – diagonal arrangement

The transducer distance is measured between the inner edges of the transducers.

In case of a measurement in diagonal mode on very small pipes, a negative transducer distance is possible.

Notice!

The accuracy of the recommended transducer distance depends on the accuracy of the entered pipe and fluid parameters.

The diagnostics window is displayed, see Fig. 9.1.

Fine adjustment of the transducer distance

- If the displayed transducer distance is adjusted, press ENTER.



The measuring run for the positioning of the transducers is started.

The bar graph S= shows the amplitude of the received signal, see Fig. 9.1.

- Shift one of the transducers slightly within the range of the recommended transducer distance until the bar graph reaches the max. length (6 squares).

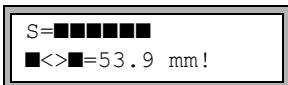
Fig. 9.1: Diagnostics window



The following quantities can be displayed in the upper line by pressing key  and in the lower line by pressing key , see Fig. 9.2:

- ■<>■ transducer distance
- time: transit time of the measuring signal in μs
- S: signal amplitude
- Q: signal quality, bar graph has to have max. length

If the signal is not sufficient for a measurement, Q= UNDEF will be displayed.

Fig. 9.2: Diagnostics window

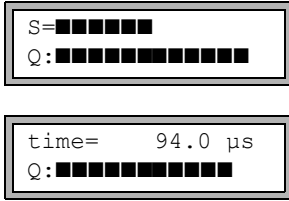

In case of large deviations, check if the entered parameters are correct or repeat the measurement at a different point on the pipe.

```
Measuring\...\Transd. Distance\54 mm
```

After the precise transducer positioning, the recommended transducer distance is displayed again.

- Enter the current (exact) transducer distance.
- Press ENTER.

Afterwards, the measurement will be started automatically.

Consistency check

If a wide range for the sound speed has been entered in the program branch `Parameter` or the exact parameters of the fluid are unknown, a consistency check is recommended.

The transducer distance can be displayed during the measurement by scrolling the key .

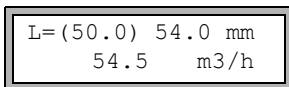

The optimum transducer distance is displayed in brackets (here: 50.0 mm) in the upper line, followed by the entered transducer distance (here: 54.0 mm). The latter value has to correspond to the adjusted transducer distance.

- Press ENTER to optimize the transducer distance.

The optimum transducer distance is calculated on the basis of the measured sound speed. It is therefore a better approximation than the first recommended value which had been calculated on the basis of the sound speed range entered in the program branch `Parameter`.

If the difference between the optimum and entered transducer distance is less than specified in Tab. 9.4, the measurement is consistent and the measured values are valid. The measurement can be continued.

- If the difference is greater, adjust the transducer distance to the displayed optimum value.
- Afterwards, check the signal quality and the signal amplitude bar graph.
- Press ENTER.

Tab. 9.4: Standard values for signal optimization

transducer frequency	max. difference between the optimum and the entered transducer distance [mm]
500 kHz	15
1 MHz	10
2 MHz	8

Notice!

If the transducer distance is changed during the measurement, the consistency check has to be repeated once again.

9.4 Display of measured values

The measured values are displayed during the measurement as follows:

Volume flow
31.82 m ³ /h

The sound speed of the fluid can be displayed during the measurement by pressing key .

If an approximate range for the sound speed has been entered in the program branch `Parameter` and the transducer distance has been optimized afterwards, it is recommended to write down the sound speed for the next measurement. By doing this, it will not be necessary to repeat the fine adjustment.

Write down the fluid temperature as the sound speed depends on it. The value can be entered in the program branch `Parameter`.

9.4.1 Adjustment of the display

During the measurement, the display can be adapted in order to display 2 measured values at the same time (one in each line of the display). This does not affect totalizing, storing of measured values, transmission of measured values, etc.

The following information can be displayed in the upper line:

display	explanation
Mass Flow	designation of the physical quantity
+8.879 m ³	values of the totalizers, if activated
full	date and time at which the data logger will be full, if activated
Mode	measuring mode
L	transducer distance
Rx	alarm state indication if activated and if alarm outputs are activated

The measured values of the physical quantity selected in the program branch `Output Options` can be displayed in the lower line:

display	explanation
12.3 m/s	flow velocity
1423 m/s	sound speed
124 kg/h	mass flow rate
15 m ³ /h	volumetric flow rate

Press key **→** during the measurement to change the display in the upper line, press key **↓** to change the display in the lower line.

Flow Velocity
* 2.47 m/s

The character * indicates that the displayed value (here: flow velocity) is not the selected physical quantity.

Status line

Important information of the running measurement is summarized in the status line. Quality and precision of the running measurement can be evaluated accordingly.

Press key  during the measurement to scroll through the upper line to the status line.

Fig. 9.3: Display of the status line

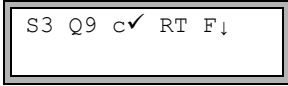

Tab. 9.5: Description of the status line

	value	explanation
S		signal amplitude
	0	< 5 %

	9	≥ 90 %
Q		signal quality
	0	< 5 %

	9	≥ 90 %
c		sound speed comparison of the measured and the expected sound speed of the fluid The expected sound speed is calculated from the fluid parameters.
	√	OK, is equal to the expected value
	↑	> 20 % of the expected value
	↓	< 20 % of the expected value
	?	unknown, cannot be measured
R		flow profile information about the flow profile based on the Reynolds number
	T	fully turbulent flow profile
	L	fully laminar flow profile
	↕	transition range between laminar and turbulent flow
	?	unknown, cannot be calculated

Tab. 9.5: Description of the status line

	value	explanation
F		flow velocity comparison of the measured flow velocity with the flow limits of the system
	√	OK, the flow velocity is not within the critical range
	↑	the flow velocity is higher than the current limit
	↓	the flow velocity is lower than the current cut-off flow
	0	the flow velocity is within the limit range of the measuring method
	?	unknown, cannot be measured

9.4.2 Transducer distance

The transducer distance can be displayed during the measurement by scrolling the key



Fig. 9.4: Display of the transducer distance

L= (51.2) 50.8 mm
54.5 m3/h

The optimum transducer distance (here: 51.2 mm) will be displayed in parentheses in the upper line, followed by the entered transducer distance (here: 50.8 mm).

The optimum transducer distance might change during the measurement (e.g., due to temperature fluctuations).

A deviation from the optimum transducer distance (here: 0.4 mm) will be compensated internally.

Notice!

Never change the transducer distance during the measurement.

9.5 Execution of special functions

Commands that can be executed during a measurement are displayed in the upper line. A command begins with →. If programmed, a program code has to be entered first.

- Press key  until the command is displayed.
- Press ENTER.

The commands available are the following:

Tab. 9.6: Executable commands during the measurement

command	explanation
-Adjust transd.	toggling to transducer positioning If a program code is active, the measurement will be continued 8 s after the last keyboard entry.
-Clear totalizer	reset of flow totalizers to zero
-Break measure	stop the measurement and return to the main menu

9.6 Determination of the flow direction

The flow direction in the pipe can be detected with the help of the displayed volumetric flow rate sign in conjunction with the arrow on the transducers:

- The fluid flows in the direction of the arrow if the displayed volumetric flow rate is positive (e.g., 54.5 m³/h).
- The fluid flows against the arrow direction if the displayed volumetric flow rate is negative (e.g., -54.5 m³/h).

9.7 Stop of the measurement

The measurement is interrupted by pressing key BRK if it is not protected by a program code, see section 18.4.

Notice!

Be careful not to stop a current measurement by inadvertently pressing key BRK.

10 Troubleshooting

Caution!



Touching hot or cold surfaces

This may result in injuries (e.g., thermal damages).

→ Observe the ambient conditions at the measuring point during installation. Wear the required personal protective equipment. Observe the applicable rules.

If any problem appears which cannot be solved with the help of this operating instruction, contact our sales office and give a precise description of the problem. Specify the type, the serial number and the firmware version of the transmitter.

The display does not work at all or fails regularly

Check the contrast setting of the transmitter or enter the HotCode **555000** to set the display to medium contrast.

Check that the battery is inserted and charged. Connect the power supply unit. If the power supply is OK, the transducers or an internal component of the transmitter are defective. The transducers and the transmitter have to be sent to SEWERIN for repair.

The message "SYSTEM ERROR" is displayed

Press key BRK to return to the main menu.

If this message is displayed repeatedly, write down the number displayed in the lower line. Track down the situations when the error is displayed. Contact SEWERIN.

The transmitter does not react when key BRK is pressed during the measurement

The program code is activated. Press key C and enter the program code.

The backlight of the display does not work, but all other functions are available

Check whether the backlight can be switched on by pressing key I/O, see section 4.4.

The backlight is defective. This problem has no influence on other functions of the display. Send the transmitter to SEWERIN for repair.

Date and time are wrong, the measured values are deleted when the transmitter is switched off

The data backup battery has to be replaced if the date and the time are reset or wrong or the measured values are deleted after the transmitter has been switched off and on. Send the transmitter to SEWERIN.

An output does not work

Make sure that the outputs are configured correctly. Check the function of the output. If the output is defective, contact SEWERIN.

10.1 Problems with the measurement

A measurement is not possible because no signal is received. A question mark is displayed after the physical quantity.

- Check whether the entered parameters are correct, especially the outer pipe diameter, the pipe wall thickness and the sound speed of the fluid. Typical errors: The circumference or the radius was entered instead of the diameter. The inner pipe diameter was entered instead of the outer pipe diameter.
- Check the number of sound paths.
- Make sure that the recommended transducer distance was adjusted when mounting the transducers.
- Make sure that an appropriate measuring point is selected and the number of sound paths was entered correctly.
- Try to establish a better acoustic contact between the pipe and the transducers.
- Enter a lower value for the number of sound paths. The signal attenuation might be too high due to a high fluid viscosity or deposits on the inner pipe wall.

The measuring signal is received but no measured values can be obtained

- A exclamation point (!) in the lower line on the right indicates that the defined upper limit of the flow velocity is exceeded and, therefore, the measured values are marked as invalid. The limit has to be adapted to the measuring conditions or the check has to be deactivated.
- If no exclamation point is displayed, a measurement at the selected measuring point is impossible.

Signal loss during the measurement

- If there is no measuring signal after the pipe had been run empty and refilled, contact SEWERIN.
- Wait a moment until the acoustic contact is reestablished. The measurement can be interrupted due to a temporarily higher proportion of gas bubbles and solids in the fluid.

The measured values substantially differ from the expected values

- Wrong measured values are often caused by wrong parameters. Make sure that the entered parameters are correct for the measuring point.

10.2 Measuring point selection

- Make sure that the recommended min. distance to any disturbance source is observed.
- Avoid measuring points with deposit formation in the pipe.
- Avoid measuring points in the vicinity of deformations and defects on the pipe as well as welds.
- Make sure the pipe surface at the selected measuring point is even.
- Measure the temperature at the measuring point and make sure that the transducers are suitable for this temperature.
- Make sure that the outer pipe diameter is within the measuring range of the transducers.
- When measuring on a horizontal pipe, the transducers have to be mounted laterally on the pipe.
- The measuring point on a vertically mounted pipe has always to be filled. The fluid should flow upward.
- No gas bubbles should form (even bubble-free fluids can form gas bubbles when the fluid expands, e.g., upstream of pumps and downstream of great cross-section enlargements).

10.3 Maximum acoustic contact

see section 6.2

10.4 Application-specific problems

A fluid with a wrong sound speed was selected

If the selected sound speed in the fluid does not match the actual one, the transducer distance can probably not be determined correctly.

The fluid sound speed is used to calculate the transducer distance and is therefore very important for the transducer positioning. The sound speeds stored in the transmitter only serve as an orientation.

The entered pipe roughness is not appropriate

Check the entered value. The pipe state should be considered.

Measurements on pipes made of porous materials (e.g., concrete or cast iron) are only conditionally possible

Contact SEWERIN.

The pipe lining may cause problems during the measurement if it is not firmly attached to the inner pipe wall or consists of acoustically absorbing material

Try to measure on a section of the pipe free from lining.

Highly viscous fluids strongly attenuate the ultrasonic signal

The measurement of fluids with a viscosity of $> 1\,000\text{ mm}^2/\text{s}$ is only conditionally possible.

A high concentration of gases or solids in the fluid scatter and absorb the ultrasonic signal and thus attenuate the measuring signal

A measurement is impossible if the value is $\geq 10\%$. If the proportion is high, but $< 10\%$, a measurement is only conditionally possible.

10.5 Significant deviations of the measured values**A fluid with a wrong sound speed was selected**

If a fluid was selected whose sound speed does not match the actual one, the measuring signal may be confused with the pipe wall signal.

The flow calculated on the basis of the wrong signal by the transmitter is very small or fluctuates around zero.

There is gas in the pipe

If there is gas in the pipe, the measured flow will be too high because both, the liquid and gas volume, are measured.

The defined upper limit of the flow velocity is too low

All measured flow velocities that are greater than the upper limit will be ignored and marked as invalid. All quantities deviated from the flow velocity will also be indicated as invalid. If several correct measured values are ignored, the totalizer values will be too low.

The entered cut-off flow is too high

All flow velocities below the cut-off flow are set to zero. All derived quantities are also set to zero. The cut-off flow has to be set to a low value to be able to measure at low flow velocities (default: 2.5 cm/s).

The entered pipe roughness is not appropriate**The flow velocity of the fluid is outside the measuring range of the transmitter****The measuring point is not appropriate**

Check whether a different measuring point provides better results. Because pipes are never rotationally symmetric, the flow profile is affected.

10.6 Problems with the totalizers

The values of the totalizers are too high

See `Special Funct.\SYSTEM settings\Measuring\Quantity recall`. If this menu item is activated, the values of the totalizer will be stored. The totalizer will continue with this value at the start of the next measurement.

The values of the totalizers are too small

One of the totalizers has reached the upper limit and has to be reset to zero manually.

The sum of the totalizers is not correct

See `Special Funct.\SYSTEM settings\Measuring\Quant. wrapping`. The sum of both totalizers (throughput) transmitted via the output is no longer valid after the first overflow (wrapping) of one of the totalizers.

11 Maintenance and cleaning

Caution!



Touching hot or cold surfaces

This may result in injuries (e.g., thermal damages).

→ Observe the ambient conditions at the measuring point during installation. Wear the required personal protective equipment. Observe the applicable rules.

11.1 Maintenance

The transmitter and the transducers are practically maintenance-free. In order to ensure security, the following maintenance intervals are recommended:

item	maintenance step	interval	measure
transducers	check of the transducer coupling on the tube	annually	replacement of the coupling foil, if necessary
transmitter	firmware check for updates	annually	update, if necessary
transmitter	functional test	annually	reading of measured and diagnostic values
transmitter	charge state of the battery	-	see section 7.2.1

11.2 Cleaning

Stainless steel housing

- Clean the stainless steel housing using a soft cloth and care and cleaning spray for stainless steel.

Aluminum housing

- Clean the aluminum housing with a soft cloth. Do not use detergents.

12 Dismounting and disposal

12.1 Dismounting

The dismounting is carried out in reverse order to its installation, see chapter 6.

12.2 Disposal

The measuring equipment has to be disposed in accordance to the applicable regulations.

Depending on the material, the corresponding parts have to be disposed in residual or special waste or recycled. For further information, contact SEWERIN.

13 Outputs

13.1 Installation of a binary output

If the transmitter is equipped with binary outputs, they have to be installed and activated before they can be used:

- assignment of the physical quantity (source item) to be transmitted to the output by the source channel, and the properties of the signal
- activation of the installed binary output in the program branch `Output Options`

Notice!

The settings will be stored at the end of the dialog. If the menu item is quit by pressing key BRK, the changes will not be stored.

```
Special Funct.\SYSTEM settings\Proc. outputs
```

- Select `Special Funct.\SYSTEM settings\Proc. outputs`.
- Press ENTER.

Selection of a binary output

```
Special Funct.\SYSTEM settings\Proc. outputs\Install Output
```

- Select the binary output to be installed.
- Press ENTER.

```
Special Funct.\SYSTEM settings\Proc. outputs\Enable B1
```

- Select `yes` to install or reconfigure the output.
- Press ENTER.
- Select `no` to uninstall the output and to return to the previous menu item in order to select another output.
- Press ENTER.

Assignment of a source item

One source item has to be assigned to each selected output.

```
Special Funct.\SYSTEM settings\Proc. outputs\...\Source item
```

- Select the physical quantity (source item) to be transmitted to the binary output by the source channel.
- Press ENTER.

The source items and their scroll lists are summarized in the following table.

Tab. 13.1: Configuration of the binary outputs

source item	list item	output
Limit	R1	limit message (Alarm Output R1)
Impuls	from abs(x)	pulse without sign consideration
	from x > 0	pulse for positive measured values of the volumetric flow rate
	from x < 0	pulse for negative measured values for the volumetric flow rate

Function test of the binary output

The function of the output can now be tested.

- Connect an external measuring instrument to the terminals of the output.

```
Special Funct.\SYSTEM settings\Proc. outputs\...\Output Test B1\
Opto-Relay OFF
```

- Select `Opto-Relay OFF` in the scroll list `Output Test` to test the de-energized state of the output.
- Press ENTER. Measure the resistance at the output. The value has to be high ohmic.

```
Special Funct.\...\B1 Output Test\B1=ON\Again?
```

- Select `yes` to repeat the test, `no` to return to the menu item `SYSTEM settings`.
- Press ENTER.

```
Special Funct.\SYSTEM settings\Proc. outputs\...\B1 Output Test\
Opto-Relay ON
```

- Select `Opto-Relay ON` in the scroll list `Output Test` to test the energized state of the output.
- Press ENTER. Measure the resistance at the output. The value has to be low ohmic.

```
Special Funct.\...\B1 Output Test\B1=ON\Again?
```

- Select `yes` to repeat the test, `no` to return to the menu item `SYSTEM settings`.
- Press ENTER.

13.2 Activation of a binary output as pulse output

A pulse output is an integrating output which emits a pulse when the volume or the mass of the fluid which has passed the measuring point reaches a given value (`Pulse Value`). The integrated quantity is the selected physical quantity. Integration is restarted as soon as a pulse is emitted.

Notice!

The menu item `Pulse Output` will only be indicated in the program branch `Output Options` if a pulse output has been installed.

```
Output Options\...\Pulse Output
```

- Press ENTER until `Pulse Output` is displayed. Select `yes` to activate the output.
- Press ENTER.

```
Output Options\...\Pulse Output\NO COUNTING
```

This error message will be displayed if the flow velocity is selected as the physical quantity. The use of the pulse output is not possible in this case because the integration of the flow velocity does not result in a reasonable value.

Output Options\...\Pulse Output\Pulse Value

- Enter the pulse value. The unit of measurement will be displayed according to the actual physical quantity.

When the counted physical quantity reaches the entered pulse value, a pulse will be transmitted.

- Press ENTER.

Output Options\...\Pulse Output\Pulse Width

- Enter the pulse width.

The range of possible pulse widths depends on the specification of the instrument (e.g., counter, PLC) that is to be connected to the output.

- Press ENTER.

The max. flow the pulse output can work with will be displayed now. This value is calculated on the basis of the entered pulse value and pulse width.

If the flow exceeds this value, the pulse output does not work correctly. In this case, the pulse value has to be increased.

- Press ENTER.

14 Data logger

The transmitter has a data logger which stores the data during the measurement.

The following data can be stored:

- date
- time
- measuring point number
- pipe parameters
- fluid parameters
- transducer data
- sound path (reflection or diagonal arrangement)
- transducer distance
- damping factor
- storage rate
- physical quantity
- unit of measurement
- values of the totalizers (in case the totalizers are activated)
- diagnostic values (in case the storing of diagnostic values is activated)

In order to store the data, the data logger has to be activated.

The available data logger can be displayed.

14.1 Activation/Deactivation of the data logger

```
Output Options\...\Store Meas.Data
```

- Select the program branch `Output Options`.
- Press ENTER until `Store Meas.Data` is displayed.
- Select `yes` to activate the data logger, `no` to deactivate it.
- Press ENTER.

14.2 Setting the storage rate

The storage rate is the frequency to transmit or store measured values. If the storage rate is not set, the storage rate previously selected will be used.

The recommended storage rate is 4 s.

```
Output Options\...\Storage Rate
```

- Select a storage rate or `EXTRA`.
- Press ENTER.

This display will only be indicated if `Store Meas.Data` and/or `Serial Output` are activated.

Output Options\...\Storage Rate\EXTRA

- Enter the storage rate if EXTRA was selected.
- Press ENTER.

14.3 Configuration of the data logger

Special Funct.\SYSTEM settings\Storing

- Select Special Funct.\SYSTEM settings\Storing.
- Press ENTER.

Starting time

In order to start the storing of measured values with several measuring instruments at the same time, it is possible to set a starting time.

Special Funct.\SYSTEM settings\Storing\Start logger

- Select the moment at which the storing has to start.

display	description
Promptly	The storing starts immediately.
On full 5 min.	The storing starts in the next full 5 minutes.
On full 10 min.	The storing starts in the next full 10 minutes.
On quarter hour	The storing starts in the next full 15 minutes.
On half hour	The storing starts in the next full 30 minutes.
On full hour	The storing starts in the next full 60 minutes.

Example

actual time: 09:06 am
 setting: On full 10 min.
 The storing starts at 09:10 am.

Ringbuffer

The setting of the ringbuffer influences the storing of measured values as soon as the data logger is full:

- If the ringbuffer is activated, the available data logger will be halved. The oldest measured values will be overwritten. Only the data logger memory that was free during the activation will be used by the ringbuffer. If more data logger memory is necessary, measured values in the data logger should be previously deleted.
- If the ringbuffer is deactivated, the storing of measured values will be stopped.

```
Special Funct.\SYSTEM settings\Storing\Ringbuffer
```

- Select **ON** to activate the ringbuffer.
- Press **ENTER**.

Storage mode

```
Special Funct.\SYSTEM settings\Storing\Storage mode
```

- Select the storage mode.
- Press **ENTER**.

If **sample** is selected, the current measured value will be used for the storing and online transmission of data.

If **average** is selected, the average of all values measured during a storage interval will be used for the storing and online transmission of data.

Notice!

The storage mode does not affect the outputs.

Notice!

Storage mode = average

The average of the physical quantity and other measurands assigned to the measuring channel, will be calculated.

If the storage rate < 5 s is selected, **sample** will be used.

If no average could be calculated over the complete storage interval, the value will be marked as invalid. The ASCII file will contain ??? for invalid average values of the data and ?UNDEF instead of invalid temperatures.

Totalizer storing

It is possible to store the currently displayed totalizer only or to store one value for each flow direction.

```
Special Funct.\SYSTEM settings\Storing\Quantity Storage
```

- Select `one` to store the currently displayed totalizer value only. This can apply for the positive and negative totalizer.
- Select `both` to store the totalizer values for both flow directions.
- Press ENTER.

Signal amplitude storing

```
Special Funct.\SYSTEM settings\Storing\Store Amplitude
```

- Select `on` to store the amplitude of the measured signal together with the measured values.
- Press ENTER.

Fluid sound speed storing

```
Special Funct.\SYSTEM settings\Storing\Store c-Medium
```

- Select `on` to store the fluid sound speed together with the measured values.
- Press ENTER.

Diagnostic values storing

```
Special Funct.\SYSTEM settings\Storing\Store diagnostic
```

- Select `on` to store the diagnostic values together with the measured values.
- Press ENTER.

14.4 Measurement with activated data logger

```
Measuring\Channel\Meas.Point No.:
```

- Start the measurement.
- Enter the number of the measuring point.
- Press ENTER.

If Output Options\Store Meas.Data is activated and Special Funct.\SYSTEM settings\Ringbuffer is deactivated, a message indicating an error will be displayed as soon as the data logger is full.

```
DATA LOGGER IS FULL!
```

- Press ENTER.

The error message will be displayed periodically.

14.5 Deletion of measured values

```
Special Funct.\Delete Meas.Val.
```

- Select Special Funct.\Delete Meas.Val.
- Press ENTER.

```
Special Funct.\Delete Meas.Val.\Really Delete?
```

- Select yes or no.
- Press ENTER.

14.6 Information relating the data logger

Approx. 100 000 measurement data can be stored. Each measured value is stored with the corresponding totalizer and optionally further measurement and diagnostic data, see section 14.3.

According to the configuration of the data logger and the stored series of measured values, the available data logger will be displayed in the menu item `Special Funct.\Instrum. Inform.`

```
Special Funct.\Instrum. Inform.
```

- Select `Special Funct.\Instrum. Inform.`
- Press ENTER.

It is recommended to delete the old series of measured values before starting a measurement, see section 14.5.

Fig. 14.1: Information relating the data logger

```
F401    -xxxxxxxxx
Free    18327
```

The type and the serial number of the transmitter are displayed in the upper line.

The available data logger will be displayed in the lower line (here: 18 327 additional measured values can be stored).

- Press key BRK twice to return to the main menu.

It is possible to store max. 100 series of measured values. The number of series of measured values depends on the total number of measured values stored in the previous series of measured values.

It is possible to display the time at which the data logger will be full during the measurement.

Press key  to scroll through the display of the upper line.

```
full= 26.01/07:39
      54.5    m3/h
```

If the ringbuffer is activated and has overflown at least once, the following display will be indicated:

```
last= 26.01/07:39
      54.5    m3/h
```

15 Data transmission

The data can be transmitted to the transmitter via the service interface RS232.

Tab. 15.1: Data transmission overview

program	data transmission	see
FluxDiagReader	offline	section 15.1
FluxDiag (optional)	online or offline	section 15.1
terminal program	online or offline	section 15.2

15.1 FluxDiagReader/FluxDiag

With the help of FluxDiagReader and FluxDiag it is possible to display measurement data, snaps and parameter settings on the PC and to export them as csv file. In order to use FluxDiagReader, the measurement has to be stopped.

In addition to this, FluxDiag allows to analyze, to compare and to visualize measurement data as well as to create reports during the measurement. A permanent data transmission via FluxDiag is not recommended.

For the operation of the program see FluxDiagReader support or FluxDiag support.

For the connection of the service interface see section 7.4.

15.2 Terminal program

If FluxDiag is not available, the measurement data can be transmitted to a terminal program in ASCII format.

15.2.1 Online transmission

The measured values are transmitted during the measurement.

The data logger works independently of the online transmission but with the same transmission rate.

- Start the terminal program.
- Enter the transmission parameters into the terminal program. The transmission parameters of the terminal program and the transmitter have to be identical, see section 15.3.

```
Output Options\Serial Output
```

- Select the program branch `Output Options`.
- Press ENTER until the menu item `Serial Output` is displayed.
- Select `yes` to activate the online transmission.
- Press ENTER.

```
Output Options\...\Serial Output\SEND ONLINE-HEAD
```

- Enter the storage rate.
- Start the measurement.

15.2.2 Offline transmission

Notice!

During the offline transmission only those data is transmitted that is stored in the transmitter.

- Start the terminal program.
- Enter the transmission parameters into the terminal program. The transmission parameters of the terminal program and the transmitter have to be identical, see section 15.3.

Transmitter settings

```
Special Funct.\Print Meas.Val.
```

- Select `Special Funct.\Print Meas.Val.`
- Press ENTER.

The following message will be displayed if no measured values are stored.

```
NO VALUES  
Print Meas.Val.
```

- Press ENTER.

The following message will be displayed if the measurement values are transmitted.

```
Send Header  
.....
```

The progress of the transmission of data is displayed by a bar graph.

```
■■■■■■■  
.....
```

The following error message will be displayed if an error has occurred during the serial transmission.

```
SERIAL ERROR
Print Meas.Val.
```

- Press ENTER.
- Check the connections and make sure the PC is ready to receive data.

15.3 Transmission parameters

- the transmitter sends CRLF-terminated ASCII
- max. line length: 255 digits

RS232 interface

default: 9600 bits/s, 8 data bits, even parity, 2 stop bits, protocol RTS/CTS (hardware, handshake)

The transmission parameters of the RS232 service interface can be changed.

- Enter the HotCode **232-0-** (see section 8.4).

```
BAUD<data par st
9600 8bit EVEN 2
```

- Set the transmission parameters in the 4 scroll lists.
- Press ENTER.
 - baud: baud rate
 - data: number of data bits
 - par: parity
 - st: number of stop bits

15.4 Data format

```
Special Funct.\SYSTEM settings\serial transmis.\SER:kill spaces
```

- Select Special Funct.\SYSTEM settings\serial transmis.
- Press ENTER until SER:kill spaces is displayed.
- Select on if the space characters are not to be transmitted.
- Press ENTER.

The file size will be considerably smaller (shorter transmission time).

```
Special Funct.\SYSTEM settings\serial transmis.\  
SER:decimalpoint
```

- Select the decimal marker to be used for floating-point numbers (point or comma).
- Press ENTER.

This setting depends on the setting of the operating system of the PC.

```
Special Funct.\SYSTEM settings\serial transmis.\  
SER:col-separat.
```

- Select the character to be used to separate columns (semicolon or tabulator).
- Press ENTER.

15.5 Data structure

First, the header is transmitted. The first 4 lines contain general information about the transmitter and the measurement. The following lines contain the parameters for each channel.

Example

```

\DEVICE           : F401 -XXXXXXXX
\MODE             : ONLINE
DATE              : 2018-01-09
TIME              : 19:56:52
Par.Record
Meas.Point No.:   : A:F5050
Pipe
  Outer Diameter  : 60.3 mm
  Wall Thickness  : 5.5 mm
  Roughness       : 0.1 mm
  Pipe Material   : Carbon Steel
  Lining          : WITHOUT LINING
Medium            : Water
  Medium Temperat. : 38 C
  Fluid pressure   : 1.00 bar
Transducer Type   : xxx
Sound Path        : 3 NUM
Transd. Distance  : -15.6 mm
Damping           : 20 s
Full-Scale Val.   : 4.50 m3/h
Physic. Quant.    : Volume flow
Unit Of Measure   : [m3/h]/[m3]
Numb.Of Meas.Val  : 100

```

Next, the line `\DATA` is transmitted. Followed by the column titles, see Tab. 15.2, for the corresponding channel. The measured values are transmitted afterwards.

Example

```

\DATA
A: \*MEASURE; Q_POS; Q_NEG;
B: \*MEASURE; Q_POS; Q_NEG;

```

Depending on the storage interval, one data line per activated measuring channel is transmitted. The line "???" will be transmitted if there are no measured values available for the storage interval.

Example

With a storage interval of 1 s, 10 lines with "???" will be transmitted if the measurement has been restarted after a 10 s interruption for the positioning of the transducers.

The following data columns can be transmitted:

Tab. 15.2: Data columns

column title	column format	content
*MEASURE	###000000.00	physical quantity selected in the program branch Output Options
Q_POS	+00000000.00	totalizer value for the positive flow direction
Q_NEG	-00000000.00	totalizer value for the negative flow direction
SSPEED		sound speed of the fluid
AMP		signal amplitude

Online transmission

Columns will be created for all quantities appearing during the measurement. The columns Q_POS and Q_NEG remain empty if the totalizers are deactivated.

As the totalizers cannot be activated for the physical quantity "flow velocity", these columns will not be generated.

Offline transmission

During the offline transmission of data, columns will only be created if at least one measured value is stored in the data set. The columns Q_POS and Q_NEG will not be generated if the totalizers are deactivated.

16 Advanced functions

16.1 Low-power mode

The low-power mode serves to prolong the battery life of the transmitter.

If the low-power mode is activated, the transmitter switches off for a certain time (resting phase) after each measurement.

Notice!

While the low-power mode is activated, the totalizers are deactivated.

16.1.1 Activation of the low-power mode

Special Funct.\SYSTEM settings\Measuring

- Select the menu item `Special Funct.\SYSTEM settings\Measuring`.
- Press ENTER.
- Select the list item `Low-power mode` to activate the low-power mode. Select `Standard` to operate the transmitter in normal measuring mode.
- Press ENTER.

Notice!

When the measuring mode is changed, the storage rate is reset to the default value. The storage rate has to be entered again.

16.1.2 Low-power mode settings

Notice!

If the low-power mode is activated, the data logger is activated as well.

In the low-power mode, the storage rate is the time interval between the starting points of 2 consecutive measurements, see Fig. 16.1.

Output Options\...\Storage Rate

- Select the program branch `Output Options`.
- Press ENTER until the menu item `Storage Rate` is displayed.

Storage Rate ↓ 10 minutes

- Select a storage rate.
- Press ENTER.

This display will only be indicated if `Low-power mode` is activated.

16.1.3 Start of the measurement

Notice!

In order to start a measurement, the parameter input has to be completed.

```
Measuring\...\Low-power mode
```

- Select the program branch `Measuring`.
- Press ENTER until the menu item `Low-power mode` is displayed.
- Select `yes` to start the measurement in the low-power mode. Select `no` to start the transmitter in normal measuring mode.
- Press ENTER.

The measurement is started, see Fig. 16.1.

Fig. 16.1: Measurement in the low-power mode

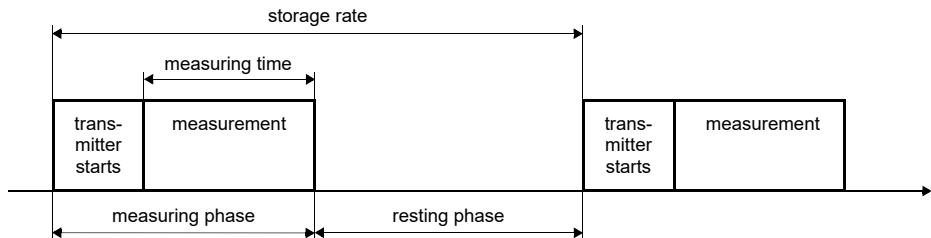

For the setting of the measuring time see section 17.3.



16.1.4 Intervention in the measurement

- Press key I/O.

The measuring phase is started. The charge state of the battery is displayed.

If no further key is pressed during the measuring time, the low-power mode will be continued with the resting phase.

Display of measured values

Press key  during the measuring time to change the display in the upper line, press key  to change the display in the lower line, see section 9.4.

At the end of the measuring time, the low-power mode will be continued.

Stop of the measurement

- Press key BRK during the measuring time.

16.2 Night-flow mode

The night-flow mode serves to detect leakages in pipes.

If the night-flow mode is activated, the transmitter changes over to a resting phase after each measurement. Once a day the transmitter switches on and starts a measurement for a certain time.

16.2.1 Activation of the night-flow mode

```
Special Funct.\SYSTEM settings\Measuring
```

- Select the menu item `Special Funct.\SYSTEM settings\Measuring`.
- Press ENTER.
- Select the list item `Nightflow mode` to activate the night-flow mode. Select `Standard` to operate the transmitter in normal measuring mode.
- Press ENTER.

Notice!

When the measuring mode is changed, the storage rate is reset to the default value. The storage rate has to be entered again.

16.2.2 Settings in the night-flow mode

Configure the data logger, see chapter 14, in such way that it does not reach its capacity limits during the planned measurement duration.

Example

If only the volumetric flow rate and one totalizer is stored, approx. 40 000 measurement data can be stored.

storage rate	duration until the logger is full at continuous measurement	measuring time per day	measurement duration
1 s	40 000 : 3600 1/h ~ 11 h	2 h	approx. 5 days
		4 h	approx. 2 days
5 s	40 000 : 720 1/h ~ 55 h	2 h	approx. 27 days
		4 h	approx. 13 days

If the storing of diagnostic values is additionally activated, see section 14.3, approx. 20 000 measurement data can be stored.

16.2.3 Start of the measurement

Notice!

In order to start a measurement, the parameter input has to be completed.

```
Measuring\...\Nightflow mode
```

- Select the program branch `Measuring`.
- Press ENTER until the menu item `Nightflow mode` is displayed.
- Select `yes` to start the measurement in the night-flow mode. Select `no` to start the transmitter in normal measuring mode.
- Press ENTER.

```
Repeat start of
measure = 02:00
```

- Enter the time when the measurement has to start each day (starting time).
- Press ENTER.

This display will only be indicated if `Nightflow mode = yes` is selected.

```
Meas. duration ↑
          1 hour
```

- Select the duration of the measurement (time of measurement).
- Press ENTER until the menu item `See you later` is displayed.

The max. measuring time is 12 h.

```
See you later...
...↑=31.01./02:00
```

The lower line displays the time the next measurement starts. The transmitter changes over to the resting phase.

16.2.4 Intervention in the measurement

If the night-flow mode is activated, the transmitter starts at the defined time. The following display appears:

```
060↑=31.01./03:00
... m3/h
```



The starting time of the next resting phase is displayed in the upper line.

```
>NIGHTFLOW OFF
... m3/h
```

- In order to deactivate the night-flow mode, scroll with key  until `NIGHTFLOW OFF` is displayed in the upper line.
- Press ENTER.

The transmitter continues measuring in normal mode. If the night-flow mode is to be activated again, the measurement has to be started.

Display of measured values

Press key  during the measuring time to change the display in the upper line, press key  to change the display in the lower line, see section 9.4.

After finishing the measuring time, the transmitter changes over to the resting phase.

Stop of the measurement

- Press key I/O.

The following display appears:

```
>Goodbye in 30 s
...      m3/h
```

- Press key BRK to deactivate the night-flow mode.

If no key is pressed, the transmitter changes over to the resting phase after completing 30 s.

16.3 Totalizers

Notice!

While the low-power mode is activated, the totalizers are deactivated.

Notice!

If the night-flow mode is activated, the totalizers are set to zero when starting a measurement.

The total volume or total mass of the fluid at the measuring point can be determined.

There are 2 totalizers, one for the positive and the other for the negative flow direction. The unit of measurement used for totalizing corresponds to the volume or mass unit selected for the physical quantity.

The totalizer values can be displayed with up to 11 places, e.g., 74890046.03. For the adjustment of the decimal places (max. 4), see section 17.8.

Display of the totalizer

- Press key  during the measurement to scroll through the upper line and display the totalizers.

```
Volume flow
54.5      m3/h
```

```
32.5      m3
54.5      m3/h
```

The totalizer value will be displayed in the upper line (here: the volume which has passed the measuring point in positive flow direction since the activation of the totalizers).

- Press ENTER while a totalizer is displayed to toggle between the display of the totalizers for both flow directions.
- Select the command →Clear totalizer in the upper line to reset the flow totalizers to zero.
- Press ENTER.

Automatic display toggling

The automatic toggling of the totalizer display between positive and negative flow direction can be set.

```
Special Funct.\SYSTEM settings\Measuring\Toggle totalizer
```

- Enter a time interval between 0 (off) and 5 s.
- Press ENTER.

Totalizer storing

It is possible to store the currently displayed totalizer only or to store one value for each flow direction.

```
Special Funct.\SYSTEM settings\Storing\Quantity Storage
```

- Select Special Funct.\SYSTEM settings\Storing\Quantity Storage.
- Press ENTER.
- If `one` is selected, only the value of the totalizer currently displayed will be stored. This can apply for the positive and negative totalizer.
- If `both` is selected, the values of the totalizers for both flow directions will be stored.
- Press ENTER.

Totalizer behavior after the measurement is stopped

The totalizer behavior when the measurement is stopped or after a reset of the transmitter is set in the menu item Special Funct.\SYSTEM settings\Measuring\Quantity recall.

```
Special Funct.\SYSTEM settings\Measuring\Quantity recall
```

- If `on` is selected, the values of the flow totalizers will be stored and used for the next measurement.
- If `off` is selected, the flow totalizers will be reset to zero.
- Press ENTER.

Totalizer overflow

The overflow behavior of the totalizers can be set:

```
Special Funct.\SYSTEM settings\Measuring\Quant. wrapping
```

- Select `Special Funct.\SYSTEM settings\Measuring\Quant. wrapping.`
- Select `on` to work with overflow.

The flow totalizer will be reset to zero automatically when ± 9999999999 is reached.

- Select `off` to work without overflow.

The value of the totalizer increases to the internal limit of 10^{38} . The values will be displayed as exponential numbers ($\pm 1.00000E10$), if necessary. The flow totalizer can only be reset to zero manually.

- Press ENTER.

Independent of the setting, the flow totalizers can be reset to zero manually.

Notice!

The overflow of a totalizer influences all output channels, e.g., data logger, online transmission of data.

The output sum of both totalizers (throughput ΣQ) transmitted via an output is not valid after the first overflow (wrapping) of one of the totalizers.

In order to signalize the overflow of a totalizer, an alarm output with the switching condition `QUANT.` and the type `HOLD` has to be activated.

16.4 NoiseTrek parallel beam mode (optional)

The NoiseTrek parallel beam mode works with parallel mounted transducers. It improves the signal quality when measuring on small pipes or with strongly attenuating fluids.

```
Special Funct.\SYSTEM settings\Measuring\Enable NoiseTrek
```

- Select the menu item `Special Funct.\SYSTEM settings\Measuring.`
- Press ENTER until the menu item `Enable NoiseTrek` is displayed.
- Select `on` to enable the NoiseTrek parallel beam mode, `off` to disable it.
- Press ENTER.

16.5 Upper limit of the flow velocity

Single outliers caused by heavily disturbed surroundings can appear among the measured values of the flow velocity. If these outliers are not ignored, they will affect all derived physical quantities, which will be unsuitable for the integration (e.g., pulse outputs). It is possible to ignore all measured flow velocities exceeding the preset upper limit. These measured values will be marked as outliers.

The upper limit of the flow velocity is set in `Special Funct.\SYSTEM settings\Measuring\Velocity limit`.

```
Special Funct.\SYSTEM settings\Measuring\Velocity limit
```

- Enter zero to switch off the outliers check.
- Enter a limit > 0 to switch on the outliers check. The measured flow velocity will then be compared to the entered upper limit.
- Press ENTER.

If the flow velocity is higher than the upper limit,

- the flow velocity will be marked as invalid. The physical quantity cannot be determined.
- a (!) will be displayed after the unit of measurement (in case of a normal error (?) is displayed).

Notice!

If the upper limit is too low, a measurement might be impossible because most of the measured values will be marked as invalid.

16.6 Cut-off flow

The cut-off flow is a lower limit for the flow velocity. All measured flow velocities that are lower than the limit and their derived quantities are set to zero.

The cut-off flow can depend on the flow direction. The cut-off flow is set in `Special Funct.\SYSTEM settings\Measuring\Cut-off Flow`.

```
Special Funct.\SYSTEM settings\Measuring\Cut-off Flow
```

- Select `sign` to define a cut-off flow depending on the flow direction. One limit is set for the positive and negative flow velocity.
- Select `absolut` to define a cut-off flow independent of the flow direction. A limit is set for the absolute value of the flow velocity.
- Press ENTER.
- Select `factory` to use the default limit of 2.5 cm/s (0.025 m/s) for the cut-off flow.
- Select `user` to enter the cut-off flow.
- Press ENTER.

If `Cut-off Flow\sign` and `user` are selected, 2 values have to be entered:

```
Special Funct.\...\+Cut-off Flow
```

- Enter the cut-off flow.
- Press ENTER.

All positive values of the flow velocity smaller than this limit are set to zero.

```
Special Funct.\...\-Cut-off Flow
```

- Enter the cut-off flow.
- Press ENTER.

All negative values of the flow velocity greater than this limit will be set to zero.

If `Cut-off Flow\absolut` and `user` are selected, only one value have to be entered:

```
Special Funct.\...\Cut-off Flow
```

- Enter the cut-off flow.
- Press ENTER.

All absolute values of the flow velocity smaller than this limit are set to zero.

16.7 Profile correction

The following settings can be made for the calculation of the fluid mechanics calibration factor k_{Re} :

- `off`: profile correction 1.0
- `on`: profile correction 2.0 at ideal inflow conditions (default)
- `With disturbance`: profile correction 2.0 at non ideal inflow conditions

The following steps are necessary to set the profile correction:

- Selection of the profile correction setting for all measuring channels in the program branch `Special Funct.`
- Input of the disturbance distance in the program branch `Parameter` if `With disturbance` has been selected

If `With disturbance` has been selected, the transducers have to be mounted in reflection arrangement, X arrangement or displaced X arrangement to compensate transverse flow effects. When mounting in X arrangement, it is essential to set the same parameters for both measuring channels and to activate for them a calculation channel with average generation.

Selection of the setting

```
Special Funct.\...\Measuring\ProfileCorr 2.0
```

- Select the menu item `Special Funct.` in the program branch `Measuring`.
- Press ENTER until the menu item `ProfileCorr 2.0` is displayed.
- Select a list item (default: `on`).
- Press ENTER.

Input of the disturbance distance

If `With disturbance` is selected in the menu item `Special Funct.\SYSTEM settings\Measuring\ProfileCorr 2.0`, the disturbance distance has to be entered in the program branch `Parameter`.

Disturb.distance
2.3 m

- Enter the disturbance distance.
- Press ENTER.

Measurement

When starting the measurement, it is checked whether the measurement arrangement is appropriate.

16.8 Uncorrected flow velocity

For special applications, the uncorrected flow velocity might be of interest.

The profile correction for the flow velocity is activated in `Special Funct.\SYSTEM settings\Measuring\Flow Velocity`.

```
Special Funct.\SYSTEM settings\Measuring\Flow Velocity
```

- Select `normal` to display and output the flow velocity with profile correction.
- Select `uncorr.` to display and output the flow velocity without profile correction.
- Press ENTER.

If `uncorr.` is selected, each time the program branch `Measuring` is selected it will be requested whether the profile correction is to be used or not.

```
PROFILE CORR.
>NO<          yes
```

If `no` is selected, the profile correction will be switched off. All physical quantities will be calculated with the uncorrected flow velocity.

During the measurement, the designation of the physical quantity is displayed in capital letters to indicate that the value is uncorrected.

```
FLOW VELOCITY
  2.60      m/s
```

- Press ENTER.

```
PROFILE CORR.
>no<          YES
```

If `yes` is selected, the uncorrected flow velocity will only be used if the flow velocity is selected as physical quantity in the program branch `Output Options`.

All other physical quantities (volumetric flow rate, mass flow rate, etc.) will be determined with the corrected flow velocity.

During the measurement, the designation of the physical quantity "flow velocity" is displayed in capital letters to indicate that the value is uncorrected.

- Press ENTER.

In both cases, the corrected flow velocity can also be displayed.

```
Flow Velocity
*U  54.5    m/s
```

Press key  to scroll until the flow velocity is displayed. The uncorrected flow velocity is marked with an "U".

Uncorrected flow velocities transmitted to a PC are marked with `uncorr.`

16.9 Diagnosis with the help of the snap function

By means of the snap function it is possible to store measuring parameters which are useful for the evaluation of measuring results or diagnosis purposes.

```
Special Funct.\SYSTEM settings\Signal snap
```

- Select `Special Funct.\SYSTEM settings\Signal snap`.
- Press ENTER.

Snap memory settings

```
Special Funct.\SYSTEM settings\Signal snap\DSP-SignalSnap
```

- Select `on` to activate the snap function and `off` to deactivate it.
- Press ENTER.

```
Special Funct.\...\DSP-SignalSnap\Install Snap
```

- Select `Install Snap`.
- Press ENTER.

```
Special Funct.\...\DSP-SignalSnap\Install Snap\Snap-Memory
```

- Enter the number of the snap memory storage space.
- Press ENTER.

```
Special Funct.\...\DSP-SignalSnap\AutoSnap
```

- Activate or deactivate the auto-snap function.
- Press ENTER.

```
Special Funct.\...\DSP-SignalSnap\Snap ringbuffer
```

- Activate or deactivate the snap ringbuffer.
- Press ENTER.

Delete snaps

```
Special Funct.\SYSTEM settings\Signal snap\DSP-SignalSnap\  
Clear Snaps
```

- Select Clear Snaps.
- Press ENTER.

Read snaps

```
Special Funct.\SYSTEM settings\Signal snap\DSP-SignalSnap\Snaps  
->Rs232
```

- Select Snaps ->Rs232.
- Press ENTER.

Activation of the snap function

- In order to activate the snap function, press key  until DSPSNAP/VOLTAGE is displayed in the upper line.
- Press ENTER.

16.10 Activation of a binary output as alarm output

Notice!

The menu item Alarm Output will only be displayed in the program branch Output Options if a binary output has been installed, see section 13.1.

```
Output Options\...\Alarm Output
```

- Press ENTER until Alarm Output is displayed. Select yes to activate the alarm output.
- Press ENTER.



16.10.1 Alarm properties

The switching condition, the holding behavior and the switching function of an alarm output can be defined.

```
R1=FUNC<typ mode
Function:    MAX
```

The following 3 scroll lists are displayed:

- `func`: switching condition
- `typ`: holding behavior
- `mode`: switching function

Press key  to select a scroll list in the upper line. Press key  to select a list item in the lower line.

- Press ENTER to store the settings.

Tab. 16.1: Alarm properties

alarm property	setting	description
func (switching condition)	MAX	The alarm will switch if the measured value exceeds the upper limit.
	MIN	The alarm will switch if the measured value falls below the lower limit.
	+→- -→+	The alarm will switch if the flow direction changes (sign change of measured value).
	QUANT.	The alarm will switch if totalizing is activated and the totalizer reaches the limit.
	ERROR	The alarm will switch if a measurement is not possible.
	OFF	The alarm is switched off.
typ (holding behavior)	NON-HOLD	If the switching condition is no longer true, the alarm will return to the idle state after approx. 1 s.
	HOLD	The alarm remains activated even if the switching condition is no longer true.
mode (switching function)	NO Cont.	The alarm is energized if the switching condition is true and de-energized if idle.
	NC Cont.	The alarm is de-energized if the switching condition is true and energized if idle.

Notice!

If no measurement is made, all alarms will be de-energized, independently of the programmed switching function.

16.10.2 Setting the limits

If the switching condition `MIN` or `MAX` is selected in the scroll list `func`, the limit of the output has to be defined:

```
R1 Input\Mass Flow
```

- Select the physical quantity to be used for the comparison in the scroll list `Input`. The following list items are available for the alarm output R1:
 - selected physical quantity
 - signal amplitude
 - sound speed of the fluid
- Press ENTER.

If the switching condition `MAX` is selected in the scroll list `func`:

```
R1 Input\Function: MAX\High Limit
```

- Enter the upper limit.
- Press ENTER.

The alarm will switch if the measured value exceeds the limit.

If the switching condition `MIN` is selected in the scroll list `func`:

```
R1 Input\Function: MIN\Low Limit
```

- Enter the lower limit.
- Press ENTER.

The alarm will switch if the measured value falls below the limit.

Example

```
High Limit: -10 kg/h
mass flow rate = -9.9 kg/h
the limit is exceeded, the alarm switches
mass flow rate = -11 kg/h
the limit is not exceeded, the alarm does not switch
```

Example

Low Limit: -10 kg/h

mass flow rate = -11 kg/h

the measured value is below the limit, the alarm switches

mass flow rate = -9.9 kg/h

the measured value is not below the limit, the alarm does not switch

If the switching condition `QUANT.` is selected in the scroll list `func`, the limit of the output has to be defined:

```
R1 Input\Function: QUANT.\Quantity Limit
```

- Enter the limit of the totalizer.
- Press ENTER.

The alarm will switch when the measured value reaches the limit.

A positive limit will be compared to the totalizer value for the positive flow direction.

A negative limit will be compared to the totalizer value for the negative flow direction.

The comparison will also take place if the totalizer of the other flow direction is displayed.

Notice!

The unit of measurement of the limit is set according to the unit of measurement of the selected physical quantity.

If the unit of measurement of the physical quantity is changed, the limit has to be converted and entered again.

Example

physical quantity: mass flow rate in kg/h

Quantity Limit: 1 kg

Example

physical quantity: mass flow rate in kg/h

Low Limit: 60 kg/h

The unit of measurement of the physical quantity is changed to kg/min. The new limit to be entered is 1 kg/min.

16.10.3 Defining the hysteresis

A hysteresis can be defined for the alarm output R1. This prevents a constant triggering of the alarm when measured values fluctuate marginally around the limit.

The hysteresis is a symmetrical range around the limit. The alarm will be activated if the measured values exceed the upper limit and deactivated if the measured values fall below the lower limit.

Example

High Limit: 30 kg/h

Hysterese: 1 kg/h

The alarm is activated for measured values > 30.5 kg/h and deactivated for measured values < 29.5 kg/h.

If the switching condition MAX or MIN is selected in the scroll list `func`:

```
R1 Input\...\Hysterese
```

- Enter a value for the hysteresis or enter zero to work without hysteresis.
- Press ENTER.

16.11 Behavior of the alarm outputs

16.11.1 Apparent switching delay

The measured values and totalizer values will be displayed rounded to 2 decimal places. The limits, however, will be compared to the non-rounded measured values. This might cause an apparent switching delay when the measured value changes marginally (less than 2 decimal places). In this case the switching accuracy of the output is higher than the accuracy of the display.

16.11.2 Reset and initialization of the alarms

After an initialization of the transmitter, all alarm outputs will be configured as follows:

Tab. 16.2: Alarm state after an initialization

func	OFF
typ	NON-HOLD
mode	NO Cont.
Limit	0.00

Press 3 times key C during the measurement to set all alarm outputs to idle state. Alarm outputs whose switching condition is still met will be activated again after 1 s. This function is used to reset alarm outputs of the type `HOLD` if the switching condition is no longer met.

By pressing key BRK, the measurement is stopped and the main menu is selected. All alarm outputs will be de-energized, independently of the programmed idle state.

16.11.3 Alarm outputs during transducer positioning

At the beginning of the transducer positioning (bar graph display), all alarm outputs switch back to the programmed idle state.

If the bar graph is selected during the measurement, all alarm outputs will switch back to the programmed idle state.

An alarm output of the type `HOLD` that has been activated during the previous measurement will remain in idle state after the transducer positioning if its switching condition is no longer met.

The switching of the alarms into idle state will not be displayed.

16.11.4 Alarm outputs during measurement

An alarm output with switching condition `MAX` or `MIN` will be updated max. once per second to avoid humming (i.e. fluctuation of the measured values around the value of the switching condition).

An alarm output of the type `NON-HOLD` will be activated if the switching condition is met. It will be deactivated if the switching condition is no longer met. The alarm remains activated for at least 1 s even if the switching condition is met for a shorter period of time.

Alarm outputs with the switching condition `QUANT.` will be activated if the limit is reached.

Alarm outputs with the switching condition `ERROR` will only be activated after several unsuccessful measuring attempts. Therefore, typical short-term disturbances of the measurement (e.g., switching on of a pump) will not activate the alarm.

Alarm outputs with the switching condition \leftrightarrow and the type `NON-HOLD` will be activated with each change of the flow direction for approx. 1 s, see Fig. 16.2.

Alarm outputs with the switching condition \leftrightarrow and of the type `HOLD` will be activated after the first change of the flow direction. They can be switched back by pressing key C 3 times, see Fig. 16.2.

Fig. 16.2: Behavior of a relay when the flow direction changes

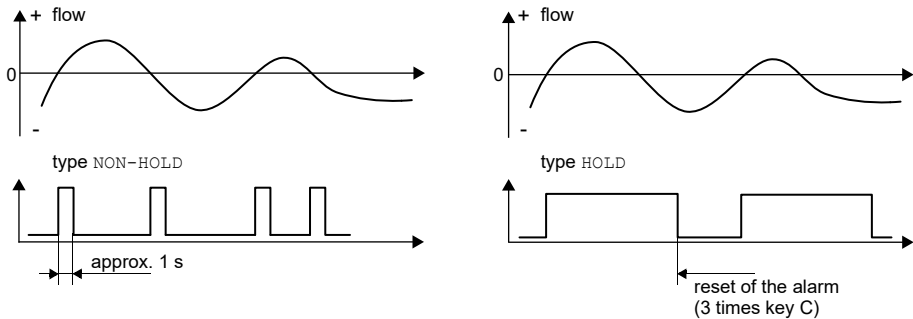

When adjusting to changed measurement conditions e.g. a substantial increase of the fluid temperature, the alarm will not be switched. Alarm outputs with the switching condition OFF will be set automatically to the switching function NO Cont.

Notice!

There is neither a visual nor an acoustic indication of the alarm output switching.

The alarm state can be displayed after the configuration of the alarm outputs and during the measurement. This function is activated in Special Funct.\SYSTEM settings\Dialogs/Menus. The activation of this function is recommended when alarm outputs have to be reconfigured frequently.

```
Special Funct.\SYSTEM settings\Dialogs/Menus\SHOW RELAIS STAT
```



- Select the menu item SHOW RELAIS STAT.
- Select on to activate the alarm state indication.
- Press ENTER.

If the alarm state indication is activated, the alarm output state is displayed after configuring the alarm outputs.

















The alarm state indication is structured as follows:

R_x = , with x being the number of the alarm output and a pictogram according to Tab. 16.3.

The configuration of the alarm outputs can be repeated by pressing key C. When the configuration of the alarm outputs is finished, press ENTER. The main menu will be displayed.

If the alarm output indication is activated, the alarm state can be displayed during the measurement. Press key  to scroll through the upper line or key  in the lower line until the alarm state is displayed.

Tab. 16.3: Pictograms for the alarm state indication

	no.		func (switching condition)	typ (holding behavior)	mode (switching function)	current state
R		=				
			 OFF	 NON-HOLD	 NO Cont.	 closed
	1		 MAX	 HOLD	 NC Cont.	 open
	2		 MIN			
	3		 +→- -→+			
			 QUANT.			
			 ERROR			

Example



16.11.5 Deactivation of an alarm output

If the programmed outputs are no longer required, they can be deactivated. The configuration of a deactivated output is stored and will be available if the output is activated again.

Output Options\...\Alarm Output

- Select no in Output Options\Alarm Output to deactivate an output.
- Press ENTER.

17 SuperUser mode

The SuperUser mode offers the possibility of an advanced diagnostic of signals and measured values as well as the definition of additional parameters adapted to the measuring point, in order to achieve better measured values or for experimental work. Special features of the SuperUser mode are:

- Default settings will not be used.
- There are no plausibility tests during the parameter entry.
- It is not checked whether the entered parameters are within the limits given by physical laws and technical data.
- The cut-off flow is not activated.
- A number of sound paths has to be entered.

Some menu items that are not visible in the normal mode are displayed.

Notice!

The SuperUser mode is intended for experienced users with advanced application knowledge. The parameters can affect the normal measuring mode and lead to wrong measured values or to a measurement failure when a new measuring point is set up.

17.1 Activation/deactivation

- Enter the HotCode **071049**, see section 8.4.
- Press ENTER.

```
SUPERUSER MODE\IS ACTIVE NOW
```

It is displayed that the SuperUser mode is activated.

- Press ENTER. The main menu will be displayed.
- Enter the HotCode **071049** again to deactivate the SuperUser mode.

```
SUPERUSER MODE\IS PASSIVE NOW
```

It is displayed that the SuperUser mode is deactivated.

- Press ENTER. The main menu will be displayed.

Notice!

Some of the defined parameters are still active after the deactivation of the SuperUser mode.

17.2 Defining flow parameters

In the SuperUser mode, it is possible to define some flow parameters (profile bounds, correction of the flow velocity) for the specific application or measuring point.

```
Special Funct.\SYSTEM settings\Measuring\Calibration
```

- Select `Special Funct.\SYSTEM settings\Measuring\Calibration`.
- Press ENTER.

17.2.1 Profile bounds

```
Special Funct.\...\Calibration\...\Profile bounds
```

- Select `user` to define the profile bounds. If `factory` is selected, the default profile bounds will be used and the menu item `Calibration` will be displayed.
- Press ENTER.

```
Special Funct.\...\Calibration\...\Laminar flow
```

- Enter the max. Reynolds number at which the flow is laminar. The entered number will be rounded to hundreds.
- Enter zero to use the default value of 1000.
- Press ENTER.

```
Special Funct.\...\Calibration\...\Turbulent flow
```

- Enter the min. Reynolds number at which the flow is turbulent. The entered number will be rounded to hundreds.
- Enter zero to use the default value of 3000.
- Press ENTER.

```
Special Funct.\...\Calibration\...\Calibration
```

A request is displayed if an additional correction of the flow velocity is to be defined.

- Select `on` to define the correction data, `off` to work without correction of the flow velocity and return to the menu item `SYSTEM settings`.

Example

profile bound for laminar flow: 1500

profile bound for turbulent flow: 2500

At Reynolds numbers < 1500, the flow is regarded as laminar for the calculation of the physical quantity. At Reynolds numbers > 2500, the flow is regarded as turbulent. The range 1500...2500 is the transition range between laminar and turbulent flow.

Notice!

The defined profile bounds are still active after the deactivation of the SuperUser mode.

17.2.2 Correction of the flow velocity

After the profile bounds have been defined, it is possible to define a correction of the flow velocity:

$$v_{\text{cor}} = m \cdot v + n$$

where

v – measured flow velocity

m – slope, range: -2.0...+2.0

n – offset, range: -12.7...+12.7 cm/s

v_{cor} – corrected flow velocity

All quantities derived from the flow velocity will be calculated with the corrected flow velocity. The correction data will be transmitted to the PC or printer during the online or offline transmission.

Notice!

It will not be displayed that the correction of the flow velocity is active during the measurement.

```
Special Funct.\...\Calibration\...\Calibration
```

- Select **on** to define the correction data, **off** to work without correction of the flow velocity and return to the menu item **SYSTEM** settings.

```
Special Funct.\...\Calibration\...\Calibration\Slope
```

- If **on** is selected, enter the slope. The input **0.0** deactivates the correction.

- Press ENTER.

```
Special Funct.\...\Calibration\...\Calibration\Offset
```

- Enter the offset. Enter zero to work without offset.
- Press ENTER.

Example

Slope: 1.1
Offset: -10.0 cm/s = -0.1 m/s

If a flow velocity $v = 5$ m/s is measured, before the calculation of the derived quantities, it will be corrected as follows:

$$v_{\text{cor}} = 1.1 \cdot 5 \text{ m/s} - 0.1 \text{ m/s} = 5.4 \text{ m/s}$$

Example

Slope: -1.0
Offset: 0.0

Only the sign of the measured values changes.

Notice!

The correction data will only be stored when a measurement is started. If the transmitter is switched off without starting a measurement, the entered correction data will be lost.

Notice!

The correction of the flow velocity is still active after the deactivation of the SuperUser mode.

17.3 Setting of the measuring time in the low-power mode

The measured values are determined during the measuring time. The current value will be stored in the data logger the end of the measuring time.

The measuring time in the low-power mode can be defined. The default value of 5 s is appropriate for normal flow conditions.

```
Special Funct.\SYSTEM settings\Measuring\Miscellaneous
```

- Select `Special Funct.\SYSTEM settings\Measuring\Miscellaneous`.
- Press ENTER until the menu item `Measuring time` is displayed.

```
Measuring time
      5      s
```

- Enter the measuring time. The max. measuring time is 60 s.
- Press ENTER.

This display will only be indicated if the low-power mode is activated.

Notice!

If a measuring time < 5 s is entered, the battery life of the transmitter is reduced.

17.4 Setting of measuring cycles in the night-flow mode

In the SuperUser mode it is possible to switch between a 24 h cycle, see section 16.2, and a user-defined cycle. The user-defined cycle allows the definition of several measuring and resting phases per day.

If the night-flow mode is activated, the menu item `Daily repeat` will be displayed at the beginning of the measurement.

```
Measuring\...\Nightflow mode\Daily repeat
```

- Select `yes` to enter a starting and measuring time and `no` to define the measuring and resting phase for the night-flow mode.
- Press ENTER.

```
Start of measure
>SETUP<      asap
```

- Select `asap` to start the user-defined cycle with the next full minute and `setup` to define the starting time.
- Press ENTER.

This display will only be indicated if `no` is selected in the menu item `Daily repeat`.

```
Start of measure
02:00
```

- Enter the starting time.
- Press ENTER.

This display will only be indicated if `setup` is selected.

```
Meas. duration ↓
1 hour
```

- Select the measuring time.
- Press ENTER.

This display will only be indicated if `no` is selected in the menu item `Daily repeat`. The max. measuring time is 12 h.

```
Sleep duration ↓
1 hour
```

- Select the resting time.
- Press ENTER.

This display will only be indicated if `no` is selected in the menu item `Daily repeat`. The max. resting time is 12 h.

17.5 Limit of the signal amplification

In order to prevent disturbing and/or pipe wall signals (e.g., if the pipe has run empty) from being interpreted as useful signals, it is possible to define a max. signal amplification. If the signal amplification is greater than the max. signal amplification,

- the flow velocity will be marked as invalid. The physical quantity cannot be determined.
- a hash symbol (#) will be displayed after the unit of measurement (in case of a normal error, (?) is displayed).

```
Special Funct.\SYSTEM settings\Measuring\Miscellaneous\
Gain threshold
```

- Select `Special Funct.\SYSTEM settings\Measuring\Miscellaneous`.
- Press ENTER until the menu item `Gain threshold` is displayed.

```
Special Funct.\SYSTEM settings\Measuring\Miscellaneous\  
Gain threshold\Fail if > 90 dB
```

- Enter for each measuring channel the max. signal amplification.
- Enter zero to measure without a limit of the signal amplification.
- Press ENTER.

The current value of the amplification (**GAIN**) can be displayed in the upper line in the program branch **Measuring**. If the current value of the amplification is higher than the max. amplification, the current value is displayed with →**FAIL!**.

Notice!

The limit of the signal amplification is still active after the deactivation of the SuperUser mode.

17.6 Upper limit of the sound speed

When the plausibility of the signal is evaluated, it will be checked whether the sound speed is within a defined range. The used upper limit of the fluid sound speed is the greatest of the following values:

- fixed upper value, default: 1848 m/s
- value of the sound speed curve of the fluid at the operating point plus offset, default offset: 300 m/s

In the SuperUser mode, the values can be defined for fluids that are not contained in the data set of the transmitter.

```
Special Funct.\SYSTEM settings\Measuring\Miscellaneous\  
Bad soundspeed
```

- **Select** Special Funct.\SYSTEM settings\Measuring\Miscellaneous.
- Press ENTER until the menu item **Bad soundspeed** is displayed.

```
Special Funct.\SYSTEM settings\Measuring\Miscellaneous\  
soundspeed\thresh.
```

- Enter for each measuring channel the fixed upper limit of the sound speed. Enter zero to use the default value of 1848 m/s.
- Press ENTER.

```
Special Funct.\SYSTEM settings\Measuring\Miscellaneous\Bad
soundspeed\offset
```

- Enter for each measuring channel the offset.
- Enter zero to use the default value of 300 m/s.
- Press ENTER.

Example

fixed upper value of the sound speed (*thresh.*): 2007 m/s

offset: 600 m/s

value of the sound speed curve at the operating point: 1546 m/s

As 1546 m/s + 600 m/s = 2146 m/s is greater than the fixed upper value 2007, this value will be used as the upper limit of the sound speed when the plausibility of the signal is evaluated.

It is possible to display the valid range for the sound speed (SS) in the lower line within the program branch *Measuring* during the measurement. The second value (here: 2146 m/s) corresponds to the upper limit at the operating point.

Fig. 17.1: Display of the valid sound speed range

GAIN=91dB
SS=1038/2146 m/s

Notice!

The defined upper limit of the sound speed remains activated after the deactivation of the SuperUser mode.

17.7 Detection of long measurement failures

If there are no valid measured values during a long time interval, new increments of the totalizers will be ignored. The values of the totalizers remain unchanged.

In the SuperUser mode, it is possible to set the time interval.

```
Special Funct.\SYSTEM settings\Measuring\Miscellaneous\Do not
total. if no meas.
```

- Select Special Funct.\SYSTEM settings\Measuring\Miscellaneous.
- Press ENTER until the menu item Do not total. if no meas. is displayed.
- Enter the time. If zero is entered, the default value of 30 s will be used.
- Press ENTER.

17.8 Number of decimal places of the totalizers

The totalizer values can be displayed with up to 11 places, e.g., 74890046.03. In the SuperUser mode, it is possible to define the number of decimal places.

```
Special Funct.\SYSTEM settings\Measuring\Miscellaneous\Total
digits
```

- Select Special Funct.\SYSTEM settings\Measuring\Miscellaneous.
- Press ENTER until the menu item Total digits is displayed.
- Select one of the following list items:
 - Automatic: dynamic adaptation
 - Fixed to x digit: x decimal places (range: 0...4)
- Press ENTER.

Total digits = Automatic

The number of decimal places will be adjusted dynamically. Low totalizer values will initially be displayed with 3 decimal places. If the values of the totalizers are higher, the number of decimal places will be reduced.

max. value	display
$< 10^6$	±0.000 ... ±999999.999
$< 10^7$	±1000000.00 ... ±9999999.99
$< 10^8$	±10000000.0 ... ±99999999.9
$< 10^{10}$	±1000000000 ... ±9999999999

Total digits = Fixed to x digit

The number of decimal points is constant. The max value of the totalizer is reduced with the number of decimal places.

decimal places	max. value	max. display
0	$< 10^{10}$	±9999999999
1	$< 10^8$	±99999999.9
2	$< 10^7$	±9999999.99
3	$< 10^6$	±999999.999
4	$< 10^5$	±99999.9999

Notice!

The number of decimal places and the max. value defined here only affect the display of the totalizers.

17.9 Manual reset of the totalizers

```
Special Funct.\SYSTEM settings\Measuring\Miscellaneous\  
3xC clear totals
```

- Select `Special Funct.\SYSTEM settings\Measuring\Miscellaneous`.
- Press `ENTER` until the menu item `3xC clear totals` is displayed.
- Select `on` to activate the manual reset of the totalizers, `off` to deactivate it.
- Press `ENTER`.

Notice!

The manual reset of the totalizers is still active after the deactivation of the SuperUser mode.

17.10 Display of the totalizer sum

The totalizer sum of both flow directions can be displayed in the upper line during the measurement.

```
Special Funct.\SYSTEM settings\Measuring\Miscellaneous\Show ΣQ
```

- Select `Special Funct.\SYSTEM settings\Measuring\Miscellaneous`.
- Press ENTER until the menu item `Show ΣQ` is displayed.
- Select `on` to activate the display of the totalizer sum, `off` to deactivate it.
- Press ENTER.

If the display of the totalizer sum is activated, the sum ΣQ of the totalizers can be displayed in the upper line during the measurement.

Fig. 17.2: Display of the totalizer sum

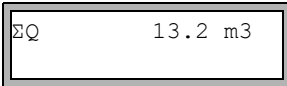

17.11 Display of the last valid measured value

If the signal is not sufficient for a measurement, `UNDEF` is normally displayed. Instead of `UNDEF`, it is also possible to display the last valid measured value.

```
Special Funct.\SYSTEM settings\Measuring\Miscellaneous\Keep display val
```

- Select `Special Funct.\SYSTEM settings\Measuring\Miscellaneous`.
- Press ENTER until the menu item `Keep display val` is displayed.
- Select `on` to activate the display of the last valid measured value, `off` to deactivate it.
- Press ENTER.

17.12 Displays during the measurement

Besides the normal information, see section 9.4, the following parameters can be displayed during the measurement in the SuperUser mode:

display	explanation
t	transit time of the measuring signal in the fluid
c	sound speed
REYNOLD	Reynolds number
VARI A	standard deviation of the signal amplitude
VARI T	standard deviation of the transit time of the measuring signal
dt-norm	transit time difference standardized to the transducer frequency
	fluid density

18 Settings

18.1 Dialogs and menus

```
Special Funct.\SYSTEM settings\Dialogs/Menu
```

- Select `Special Funct.\SYSTEM settings\Dialogs/Menu`.
- Press ENTER.

Notice!

The settings will be stored at the end of the dialog. If the menu item is quit by pressing key BRK, the changes will not be stored.

18.1.1 Pipe circumference

```
Special Funct.\...\Dialogs/Menu\Pipe Circumfer.
```

- Select `on` if the pipe circumference is to be entered instead of the pipe diameter in the program branch `Parameter`.
- Press ENTER.

```
Special Funct.\...\Dialogs/Menu\Pipe Circumfer.\Outer Diameter
```

If `on` is selected for `Pipe Circumfer.`, the outer pipe diameter will still be requested in the program branch `Parameter`.

- In order to select the menu item `Pipe Circumfer.`, enter zero.
- Press ENTER.

The value displayed in `Pipe Circumfer.` is calculated on the basis of the last displayed value of the outer pipe diameter.

Example: $100 \text{ mm} \cdot \pi = 314.2 \text{ mm}$

- Enter the pipe circumference. The limits for the pipe circumference are calculated on the basis of the limits for the outer pipe diameter.
- Press ENTER.

During the next scroll through the program branch `Parameter`, the outer pipe diameter that corresponds to the entered pipe circumference will be displayed.

Example: $180 \text{ mm} : \pi = 57.3 \text{ mm}$

Notice!

The edition of the pipe circumference is only temporarily. When the transmitter switches back to the display of the pipe circumference (internal recalculation), slight rounding errors may occur.

Example

entered pipe circumference: 100 mm
displayed outer pipe diameter: 31.8 mm

When the transmitter switches back to the display of the pipe circumference, 99.9 mm will be displayed.

18.1.2 Measuring point number

```
Special Funct.\...\Dialogs/Menu\Meas.Point No.
```

- Select (1234) if the measuring point is to be identified only by numbers, point and hyphen.
- Select (↑↓←→) if the measuring point is to be designated with ASCII characters.
- Press ENTER.

18.1.3 Transducer distance

```
Special Funct.\...\Dialogs/Menu\Transd. Distance
```

recommended setting: `user`

- `user` will be selected if the measuring point is always the same
- `auto` can be selected if the measuring point often changes

In the program branch `Measuring`, the recommended transducer distance will be displayed in parentheses, followed by the entered transducer distance if the recommended and the entered transducer distance are not identical.

Transd. Distance (50.8) 50.0 mm

During the transducer positioning, in the program branch `Measuring`

- only the entered transducer distance will be displayed if `Transd. Distance = user` is selected and the recommended and the entered transducer distances are identical
- only the recommended transducer distance will be displayed if `Transd. Distance = auto` is selected

18.1.4 Error delay

The error delay is the time interval after which the entered value for the error value is transmitted to the output in case no valid measured values are available.

```
Special Funct.\...\Dialogs/Menus/Error-val. delay
```

- Select `damping` if the damping factor is to be used as the error delay. Select `edit` to activate the menu item `Error-val. delay` in the program branch `Output Options`. From now on, the error delay can be entered in the program branch `Output Options`.
- Press ENTER.

18.1.5 Alarm state indication

```
Special Funct.\...\Dialogs/Menus\SHOW RELAIS STAT
```

- Select `on` to display the alarm state during the measurement.
- Press ENTER.

18.1.6 Units of measurement

It is possible to set the units of measurement for the length, temperature, pressure, density and kinematic viscosity and sound speed.

- Select a unit of measurement for all quantities.
- Press ENTER after each selection.

18.1.7 Settings relating the fluid pressure

It is possible to set whether the absolute or the relative pressure is to be used:

```
Special Funct.\...\Dialogs/Menus\Pressure absolut
```

- Select `on` or `off`.
- Press ENTER.

If `on` is selected, the absolute pressure p_a will be displayed/input/transmitted.

If `off` is selected, the relative pressure p_g will be displayed/input/transmitted.

$$p_g = p_a - 1.01 \text{ bar}$$

The pressure and its unit of measurement will, e.g., be displayed in the program branch `Parameter`. It is followed by the selected pressure, indicated in parentheses:

a – absolute pressure

g – relative pressure

```
Fluid pressure
  1.00 bar(a)
```

18.2 Measurement settings

Special Funct.\SYSTEM settings\Measuring

- Select Special Funct.\SYSTEM settings\Measuring.
- Press ENTER.

Notice!

The settings will be stored at the end of the dialog. If the menu item is quit by pressing key BRK, the changes will not be stored.

Special Funct.\...\Measuring\Compare c-fluid

- Select **yes** if the measured sound speed is to be compared to the theoretical or expected value.
- Press ENTER.

The difference $\delta c = c_{\text{mea}} - c_{\text{stored}}$ between the two sound speeds will be displayed in the lower line during the measurement. c_{stored} is the sound speed of the reference fluid stored in the database.

- Press key  during the measurement to scroll to the display of δc .

Special Funct.\...\Measuring\ProfileCorr 2.0

- Select a list item:
 - off: profile correction 1.0
 - on: profile correction 2.0 at ideal inflow conditions (default)
 - With disturbance: profile correction 2.0 at non ideal inflow conditions
- Press ENTER.

Special Funct.\...\Measuring\Flow Velocity

- Select **normal** to display and transmit the profile corrected flow values, **uncorr.** to display and output the flow values without flow profile correction.
- Press ENTER.

For further information, see section 16.8.

```
Special Funct.\...\Measuring\Velocity limit
```

An upper limit for the flow velocity can be entered, see section 16.5.

- Enter zero to deactivate the flow velocity check.
- Press ENTER.

```
Special Funct.\...\Measuring\Cut-off Flow
```

A lower limit for the flow velocity can be entered.

- Select `sign` to define a cut-off flow depending on the flow direction. One limit is set for the positive and negative flow velocity.
- Select `absolut` to define a cut-off flow independent of the flow direction. A limit is set for the absolute value of the flow velocity.
- Press ENTER.
- Select `factory` to use the default limit of 2.5 cm/s (0.025 m/s) for the cut-off flow.
- Select `user` to enter the cut-off flow.
- Press ENTER.

If `Cut-off Flow\sign` and `user` are selected, 2 values have to be entered:

```
Special Funct.\...\Measuring\Cut-off Flow\+Cut-off Flow
```

- Enter the cut-off flow.
- Press ENTER.

All positive values of the flow velocity smaller than this limit are set to zero.

```
Special Funct.\...\Measuring\Cut-off Flow\ -Cut-off Flow
```

- Enter the cut-off flow.
- Press ENTER.

All negative values of the flow velocity greater than this limit will be set to zero.

If `Cut-off Flow\absolut` and `user` are selected, only one value have to be entered:

```
Special Funct.\...\Measuring\Cut-off Flow
```

- Enter the cut-off flow.
- Press ENTER.

The absolute value of all flow velocity values lower than this limit will be set to zero.

Special Funct.\...\Measuring\Quant. wrapping

- Select the overflow behavior of the totalizers, see section 16.3.
- Press ENTER.

Special Funct.\...\Measuring\Quantity recall

- Select **on** to keep the previous totalizer values after a restart of the measurement.
- Select **off** to reset the totalizers to zero after a restart of the measurement.
- Press ENTER.

Special Funct.\...\Measuring\Toggle totalizer

It is possible to set a time period after which the display toggles between the positive and the negative totalizer during the measurement.

- Enter a time interval between 0 (off) and 5 s.
- Press ENTER.

This display will not be indicated if the low-power mode is activated.

Special Funct.\...\Measuring\Turbulence mode

The activation of the turbulence mode can enhance the signal quality if the flow is highly turbulent (e.g., in the vicinity of an elbow or valve). An SNR value of min. 6 dB is required during the measurement.

- Select **on** to activate the turbulence mode.
- Press ENTER.

18.3 Contrast settings

```
Special Funct.\SYSTEM settings\Miscellaneous
```

- Select Special Funct.\SYSTEM settings\Miscellaneous.
- Press ENTER.

```
Special Funct.\SYSTEM settings\Miscellaneous\SETUP DISPLAY
```

- Select Special Funct.\SYSTEM settings\Miscellaneous to set the display contrast of the transmitter.

The display contrast is adjusted with the following keys:

 increases the contrast

 reduces the contrast

- Press ENTER.

It is possible to reset the display to medium contrast by means of a HotCode.

- Enter the HotCode **555000**, see section 8.4.

Notice!

After an initialization of the transmitter, the display is reset to medium contrast.

18.4 Program code

A running measurement can be protected against inadvertent intervention by a program code.

If a program code has been defined, it will be requested in case of any intervention in the measurement (a command or key BRK).

18.4.1 Defining a program code

```
Special Funct.\Program code
```

- Select Special Funct.\Program code.
- Press ENTER.
- Enter a program code with max. 6 digits.
- Press ENTER.

An error message will be displayed if a reserved number has been entered (e.g., a HotCode for language selection).

```
INVALID CODE !
909049
```

A program code will remain valid as long as:

- no other valid program code is entered or
- the program code is not deactivated

Notice!

Do not forget the program code!



18.4.2 Intervention in the measurement

If a program code is activated, the message `PROGRAM CODE ACTIVE` will be displayed for a few seconds when a key is pressed.

If key BRK is pressed:

In order to stop a running measurement, the complete program code has to be entered (= Break Code).

```
INPUT BREAK_CODE
CODE:      000000
```

- Enter the program code with the keys  and .
- Press ENTER.

If the entered program code is invalid, an error message will be displayed for a few seconds.



```
INPUT BREAK_CODE
INVALID CODE !
```

If the entered program code is valid, the measurement will be stopped.

If a command is selected:

In order to execute a command, it is sufficient to enter the first 3 digits of the program code (= Access Code).

```
INP. ACCESS CODE
CODE:      000000
```

- Enter the first 3 digits of the program code with the keys  and .
- Press ENTER.

At first, 000000 is displayed. If the program code starts with 000, ENTER can be pressed immediately.

18.4.3 Deactivation of the program code

```
Special Funct.\Program code
```

- Select Special Funct.\Program code.
- Press ENTER.
- Enter "-----" to delete the program code.
- Press ENTER.

If the character "-" is entered less than 6 times, this character sequence will be used as the new program code.

Annex

A Menu structure

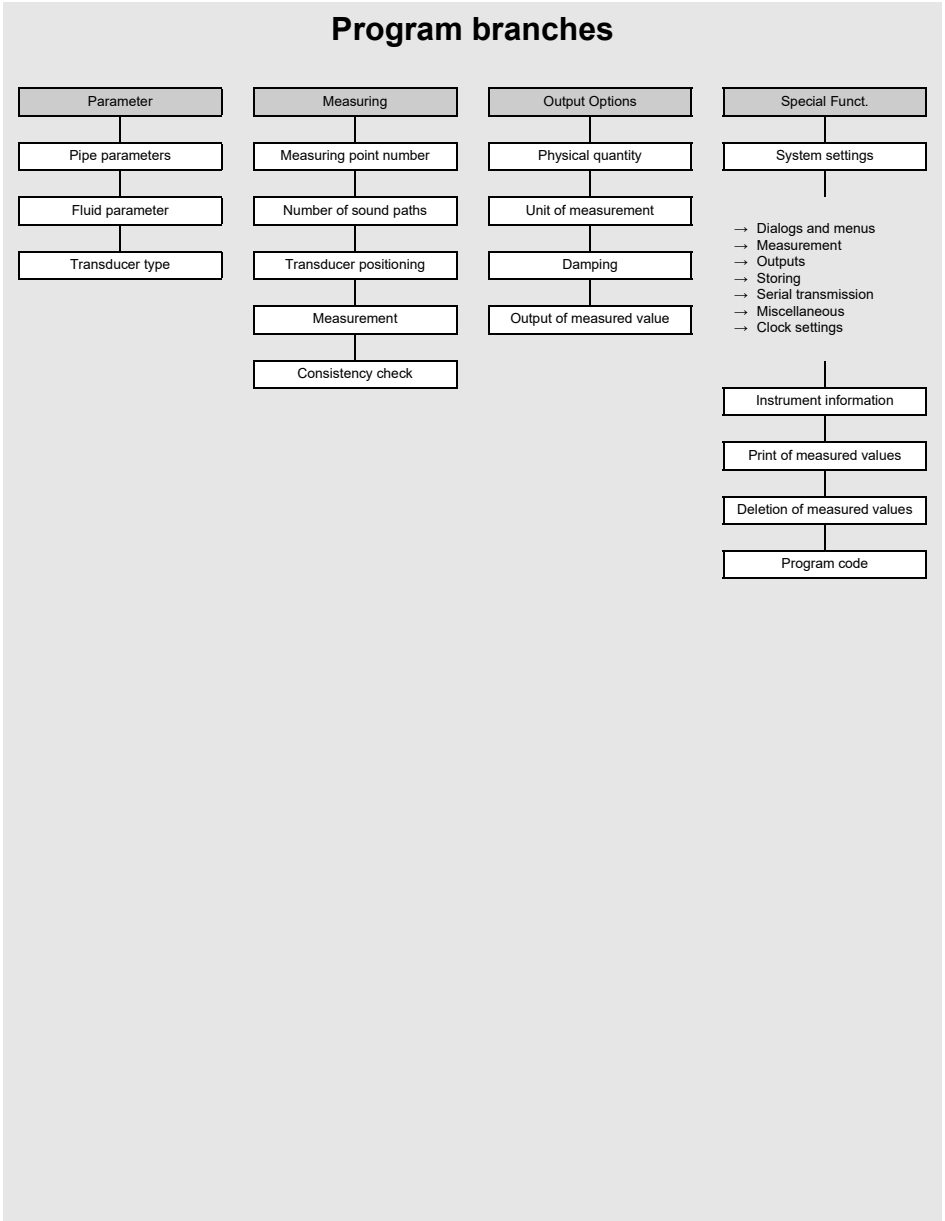

Parameter input

(see chapter 9)

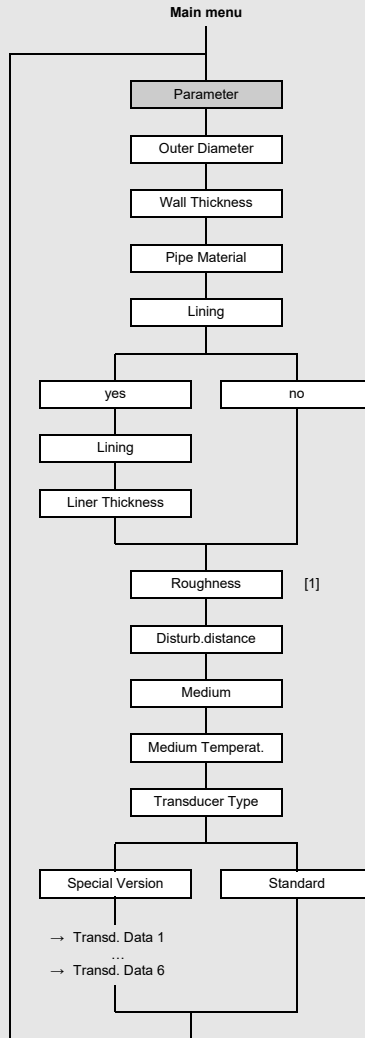

Legend

[1] only if With disturbance is selected in the menu item Special Funct.\SYSTEM settings\Measuring\ProfileCorr 2.0

Measurement settings

(see chapter 9)

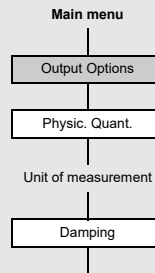

Data logger

(see chapter 14)

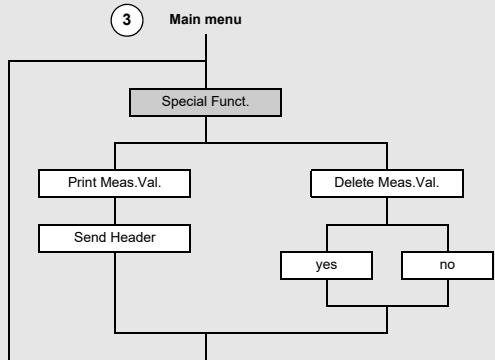
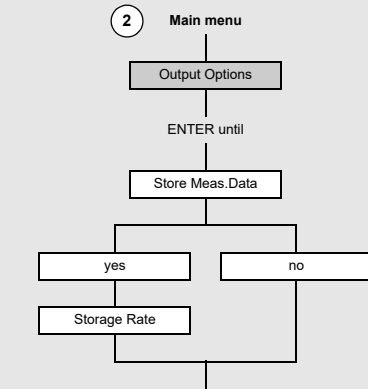
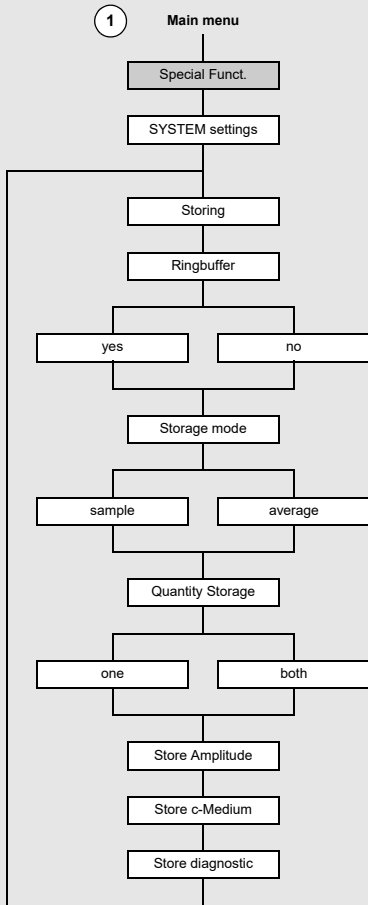

Measurement start

(see chapter 9)

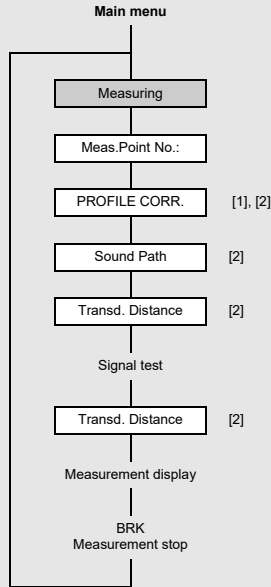

Legend

- [1] this will only be displayed if uncorr. is selected in the menu item Special Funct. \ SYSTEM settings\Measuring\Flow Velocity
- [2] this will only be displayed if Enable NoiseTrek has not been activated in the menu item Special Funct. \SYSTEM settings\Measuring

Configuration of the outputs

(see chapter 9)

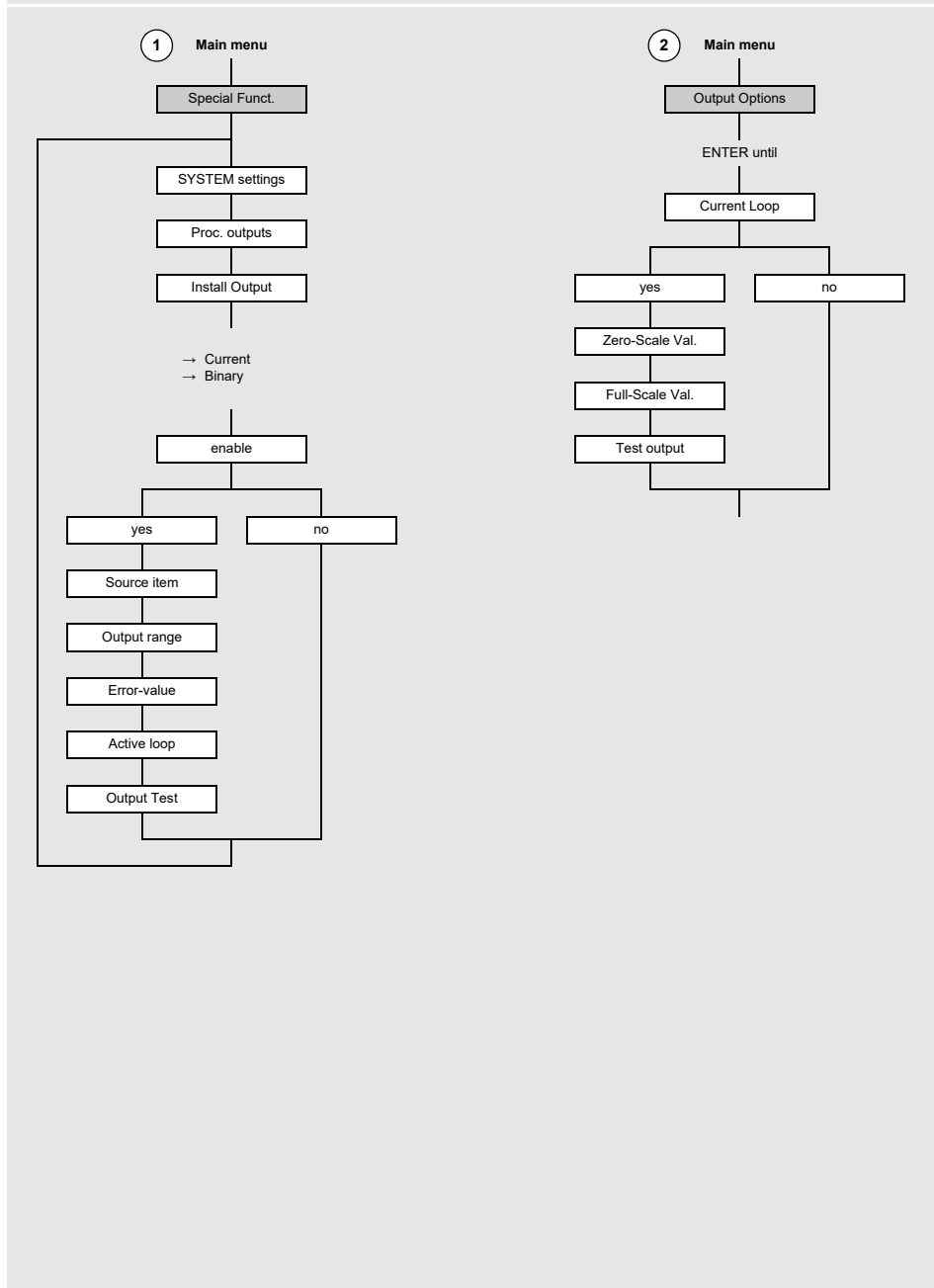

SuperUser mode

(see chapter 17)

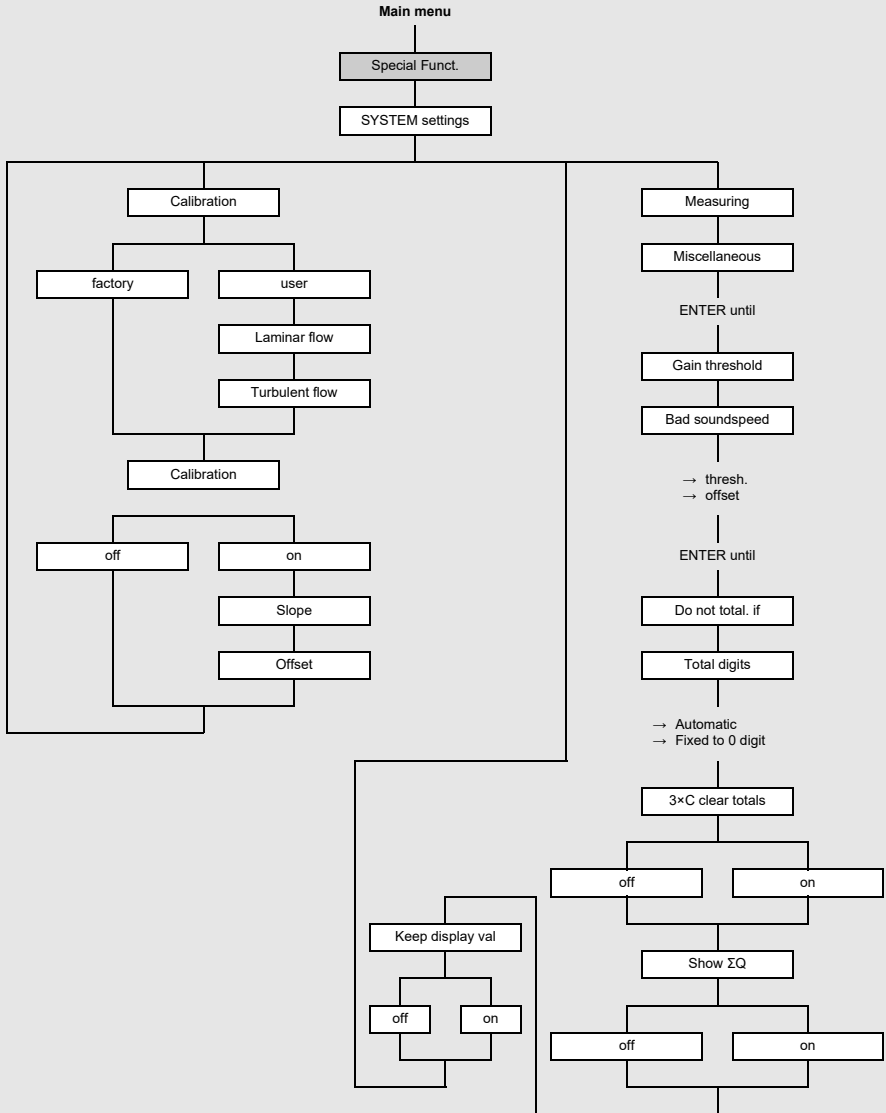

Alarm output

(see chapter 16)

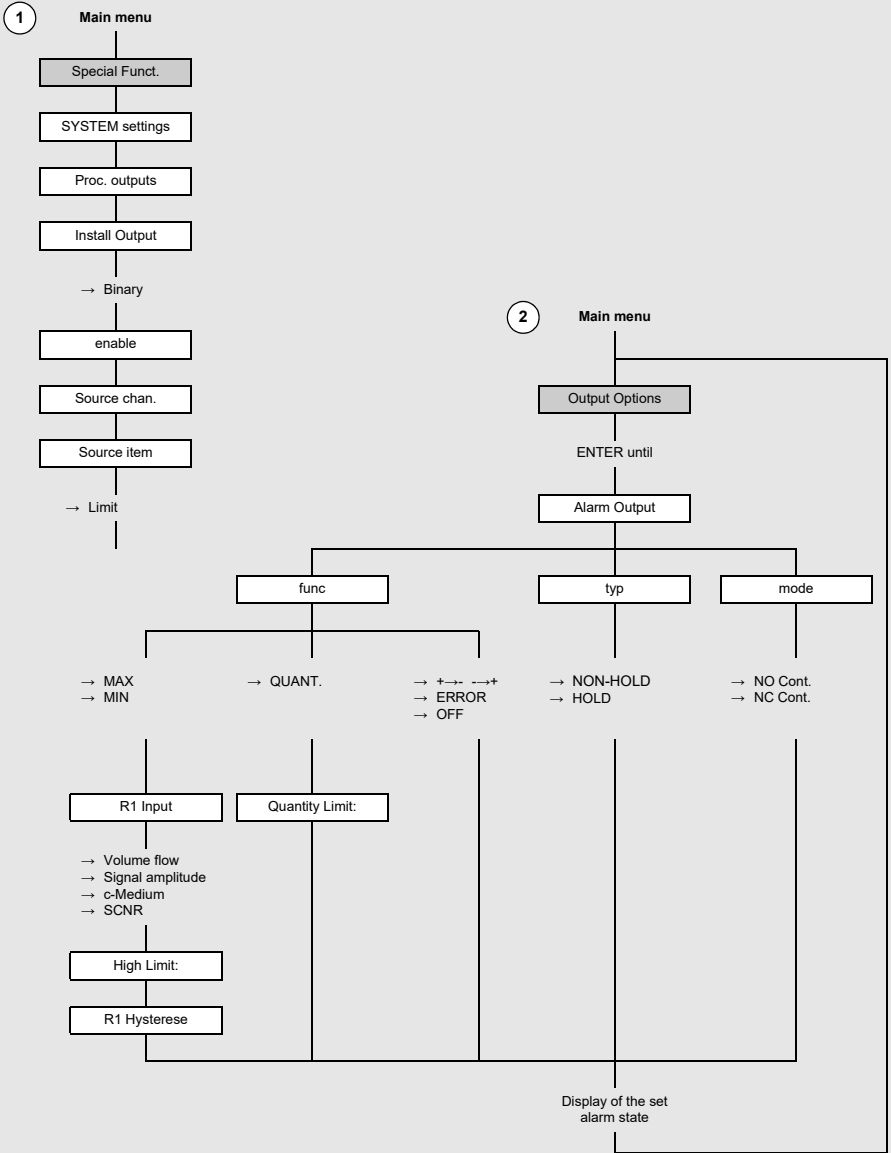

B Units of measurement

Length/roughness

unit of measurement	description
mm	millimeter
inch	inch

Temperature

unit of measurement	description
°C	degree Celsius
°F	degree Fahrenheit

Pressure

unit of measurement	description
bar(a)	bar (absolute)
bar(g)	bar (relative)
psi(a)	pound per square inch (absolute)
psi(g)	pound per square inch (relative)

Density

unit of measurement	description
g/cm ³	gram per cubic centimeter
kg/cm ³	kilogram per cubic centimeter

Sound speed

unit of measurement	description
m/s	meter per second

Kinematic viscosity

unit of measurement	description
mm ² /s	square millimeter per second

1 mm²/s = 1 cSt

Flow velocity

unit of measurement	description
m/s	meter per second
cm/s	centimeter per second
inch/s	inch per second
fps (ft/s)	foot per second

Volumetric flow rate

unit of measurement	description	volume (totalized)
m ³ /d	cubic meter per day	m ³
m ³ /h	cubic meter per hour	m ³
m ³ /min	cubic meter per minute	m ³
m ³ /s	cubic meter per second	m ³
km ³ /h	cubic kilometer per hour	km ³
ml/min	milliliter per minute	l
l/h	liter per hour	l
l/min	liter per minute	l
l/s	liter per second	l
hl/h	hectoliter per hour	hl

(1) cft: cubic foot

(2) aft: acre foot

1 US-gal = 3.78541 l

1 UK-gal = 4.54609 l

1 bbl = US Oil ≈ 159 l

1 bbl = US Wine ≈ 119 l

1 bbl = US Beer ≈ 117 l

1 bbl = UK ≈ 164 l

unit of measurement	description	volume (totalized)
hl/min	hectoliter per minute	hl
hl/s	hectoliter per second	hl
Ml/d (megaliter/d)	megaliter per day	Ml
bbl/d	barrel per day	bbl
bbl/h	barrel per hour	bbl
bbl/m	barrel per minute	bbl
bbl/s	barrel per second	bbl
USgpd (US-gal/d)	gallon per day	gal
USgph (US-gal/h)	gallon per hour	gal
USgpm (US-gal/m)	gallon per minute	gal
USgps (US-gal/s)	gallon per second	gal
KGPM (US-Kgal/m)	kilogallon per minute	kgal
MGD (US-Mgal/d)	million gallons per day	Mg
IGPD (UK-gal/d)	gallon per day	lgal
CFD	cubic foot per day	cft ⁽¹⁾
CFH	cubic foot per hour	cft
CFM	cubic foot per minute	cft
CFS	cubic foot per second	aft ⁽²⁾
MMCFD	million cubic feet per day	MMCF
MMCFH	million cubic feet per hour	MMCF

⁽¹⁾ cft: cubic foot

⁽²⁾ aft: acre foot

1 US-gal = 3.78541 l

1 UK-gal = 4.54609 l

1 bbl = US Oil ≈ 159 l

1 bbl = US Wine ≈ 119 l

1 bbl = US Beer ≈ 117 l

1 bbl = UK ≈ 164 l

Mass flow rate

unit of measurement	description
t/h	ton per hour
t/d	ton per day
kg/h	kilogram per hour
kg/min	kilogram per minute
kg/s	kilogram per second
g/s	gram per second
lb/d	pound per day
lb/h	pound per hour
lb/m	pound per minute
lb/s	pound per second
klb/h	kilopound per hour
klb/m	kilopound per minute

mass (totalized)
t
t
kg
kg
kg
g
lb
lb
lb
lb
klb
klb

1 lb = 453.59237 g

1 t = 1000 kg

C Reference

The following tables provide assistance for the user. The accuracy of the data depends on the composition, temperature and processing of the material. SEWERIN does not assume liability for any inaccuracies.

C.1 Sound speed of selected pipe and lining materials at 20 °C

The values of some of these materials are stored in the internal database of the transmitter. Column c_{flow} shows the sound speed (longitudinal or transversal) used for the flow measurement.

material (display)	explanation	c_{trans} [m/s]	c_{long} [m/s]	c_{flow}
Carbon Steel	steel, normal	3230	5930	trans
Stainless Steel	steel, stainless	3100	5790	trans
DUPLEX	duplex stainless steel	3272	5720	trans
Ductile Iron	ductile iron	2650	-	trans
Asbestos Cement	asbestos cement	2200	-	trans
Titanium	titanium	3067	5955	trans
Copper	copper	2260	4700	trans
Aluminium	aluminum	3100	6300	trans
Brass	brass	2100	4300	trans
Plastic	plastic	1120	2000	long
GRP	glass reinforced plastic (GRP)	-	2650	long
PVC	polyvinyl chloride	-	2395	long
PE	polyethylene	540	1950	long
PP	polypropylene	2600	2550	trans
Bitumen	bitumen	2500	-	trans
Acrylic	acrylic glass	1250	2730	long
Lead	lead	700	2200	long
Cu-Ni-Fe	copper-nickel-iron alloy	2510	4900	trans
Grey Cast Iron	gray cast iron	2200	4600	trans
Rubber	rubber	1900	2400	trans
Glass	glass	3400	5600	trans

material (display)	explanation	c_{trans} [m/s]	c_{long} [m/s]	c_{flow}
PFA	perfluoralcoxy	500	1185	long
PVDF	polyvinylidene fluorid	760	2050	long
Sintimid	Sintimid	-	2472	long
Teka PEEK	Teka PEEK	-	2534	long
Tekason	Tekason	-	2230	long

The sound speed depends on the composition and the manufacturing process of the material. The sound speed of alloys and cast materials fluctuates strongly. The values only serve as an orientation.

C.2 Typical roughness values of pipes

The values are based on experience and measurements.

material	absolute roughness [mm]
drawn pipes of non-ferrous metal, glass, plastics and light metal	0...0.0015
drawn steel pipes	0.01...0.05
fine-planed, polished surface	max. 0.01
planed surface	0.01...0.04
rough-planed surface	0.05...0.1
welded steel pipes, new	0.05...0.1
after long use, cleaned	0.15...0.2
moderately rusted, slightly encrusted	max. 0.4
heavily encrusted	max. 3
cast iron pipes:	
bitumen lining	> 0.12
new, without lining	0.25...1
rusted	1...1.5
encrusted	1.5...3

C.3 Properties of water at 1 bar and at saturation pressure

fluid temperature [°C]	fluid pressure [bar]	sound speed [m/s]	density [kg/m ³]	specific heat capacity ¹ [kJ/kg/K ⁻¹]
0.1	1,013	1402.9	999.8	4,219
10	1,013	1447.3	999.7	4,195
20	1,013	1482.3	998.2	4,184
30	1,013	1509.2	995.6	4,180
40	1,013	1528.9	992.2	4,179
50	1,013	1542.6	988.0	4,181
60	1,013	1551.0	983.2	4,185
70	1,013	1554.7	977.8	4,190
80	1,013	1554.4	971.8	4,197
90	1,013	1550.5	965.3	4,205
100	1,013	1543.2	958.3	4,216
120	1,985	1519.9	943.1	4,244
140	3,615	1486.2	926.1	4,283
160	6,182	1443.2	907.4	4,335
180	10.03	1391.7	887.0	4,405
200	15.55	1332.1	864.7	4,496
220	23.20	1264.5	840.2	4,615
240	33.47	1189.0	813.4	4,772
260	46.92	1105.3	783.6	4,986
280	64.17	1012.6	750.3	5,289
300	85.88	909.40	712.1	5,750
320	112.8	793.16	667.1	6,537
340	146.0	658.27	610.7	8,208
360	186.7	479.74	527.6	15.00
373,946	220,640	72,356	322.0	∞

¹ at constant pressure